

\$15

MY CAS-KER
ACCOUNT NUMBER

Catalog #9, SKU 900.103.10

TOOLS + supplies

for jewelers and watchmakers



Cas-Ker is your trusted and timely source for precision watchmakers' and jewelers' tools and supplies since 1927.

Cas-KerCo.

1-800-487-0408 / CASKER.COM

Do MORE of what you LOVE with jewelry & watchmaking supplies from Cas-Ker Co.

Cas-Ker co. is a full service distributor to professional jewelers and watchmakers. Our inventory may be the world's largest selection of horological products including watch parts, batteries, jewelers' and watchmakers' tools and supplies, findings, watchbands, gift boxes, and more.

We're your one-stop-shop for everything from top-of-the-line precision tools to vintage watch parts that can't be found anywhere else.

CALL **1-800-487-0408**
FAX **1-800-487-5848**
LOCAL **513-674-7700**
CASKER.COM
cascker@cascker.com

2550 CIVIC CENTER DR
CINCINNATI OH 45231-0167



Cas-Ker Co.

CALL Monday through Thursday
8:30am - 5:30pm Eastern Time (6pm
Central, 5pm Mountain, 4pm Pacific).
Friday 8:00am - 5:00PM all time zones.

Cincinnati Pick-Up Counter open
Monday through Friday 8:30am - 3:00pm
Eastern Time.

For NEXT DAY DELIVERY, call by 3:00pm
your local time Monday through
Thursday, by 3:00pm Eastern Time Friday.

Family owned since its inception in 1927, Cas-Ker Co. is proud to offer the best customer service and an incredible selection of jewelry and watch tools, supplies, and materials.

The Cassidy brothers represent the third generation of family ownership and operation.

Experience Cas-Ker's fast, friendly, and knowledgeable customer service! When you call in your order, you'll speak to an experienced expert who knows horological and jewelers materials, tools and supplies.

ORDERING

For the fastest service **Fax Your Order: 1-800-487-5848** early in the day. Please include the following information with all orders:

- Your Customer Number.
- Purchase Order Number if applicable.
- Quantity, Stock Number and Description of each item ordered.

Please provide your complete street address and phone number when ordering for the first time.

Phones Open Monday through Thursday 8:30AM Eastern until 4:00PM Pacific, 5:00PM Mountain, 6:00PM Central, 5:30PM Eastern.

Phones Open Friday 8:00AM until 5:00PM Eastern

ACCOUNTS

Firms with satisfactory credit ratings by the Jewelers' Board of Trade will be shipped instantly on open account. If you are not JBT rated and wish to open a Cas-Ker account, please call us to request a credit application. You must supply at least three trade references and your bank name. Please allow 7-10 days for approval of signed application.

Invoice Terms: Net 10/EOM to customers with approved credit.

We accept Visa, MasterCard & Discover.

RETURNS

If you are not satisfied with any order when it arrives, you may return it for a prompt exchange or refund. Please include copy of invoice and reason for return. No returns accepted after 15 days, or on any special order items. Returned items must be in sellable condition.

PRICING

Prices in this catalog are accurate as of December 2017. Due to the fluctuation of foreign currency and normal price increases, prices are subject to change without notice. We have made every effort to ensure accuracy of information in this catalog, and are not responsible for typographical errors. The latest version of this catalog can be downloaded from our website, www.casker.com.

SHIPPING

Cas-Ker ships via USPS, UPS Ground & Air and FedEx Air. Your order will be shipped the most convenient way unless you specify otherwise. Lithium batteries must be shipped UPS Ground.

For Next Day and Second Day delivery please order by 3:00PM your local time Monday - Thursday (Friday order by 3:00PM Eastern).

Alaska, Hawaii and Puerto Rico orders shipped via US Priority Mail or UPS Air Service. International Orders must be prepaid in US dollars with Visa, MasterCard, Discover or a wire transfer. International shipping is via UPS.

Back ordered merchandise is shipped as soon as it is available at no additional shipping charges. Items not normally stocked by Cas-Ker must be special ordered. These items are not returnable and are subject to shipping charges.

100% SATISFACTION GUARANTEED

Buy with confidence. If you are not 100% satisfied with your order when it arrives, you may return it for a prompt exchange or refund.

Abrasives	36-49
Adhesives	263-266
Bags, Boxes & Packaging	344-350
Batteries, Energizer Watch	436-438
Beading Supplies	194-198
Benches and Accessories	311-312
Books	306-310
Bracelet /Spring Bar Tools	109-116
Broaches	98, 134
Brushes	56-62
Bufs	48-55
Burnishers	133
Burs	135-144
Case Openers & Crystal Presses	76-89
Casting	290-302
Cleaning Solutions	5-6, 15-21, 262
Clock Tools, Supplies, Movements	121-124
Cutters, Shears	156, 166
Dapping, Punching, Stamping, Anvils	125-128
Demagnetizers	64-66
Diamond Testing & Supplies	225-231
Displays	352-367
Drills	145-147
Dust Removal	25-27, 262
Engraving	128-132
Eyeloupes	315-320
Files	232-242
Flex-Shafts & Grinding Motors	149-154
Gauges	211-216
Gold Testing	221-224
Hammers & Mallets	243-246
Jeweler's Findings	369-376
Knives & Scrapers	247
Lamps	313-314
Magnifiers	321-328
Mandrels	39, 47, 148
Medical Alert Jewelry	434-435
Metals, Wire, Sheet & Casting	303-304
Microscopes	328-330
Movement Holders	90-91
Oil, Lubricants & Applicators	252-260
Pickling	283-284
Pin Vises	118-119
Plating	285-288
Pliers & Cutters	155-170
Polishing	20-35
Ring Guards	199-200
Ring Tools	201-210
Safety Supplies, Gloves & Glasses	331-333
Sawing	248-249
Scales	217-220
Screwdrivers	172-179
Soldering	268-283
Steam Cleaners	10-12
Stone Setting Tools	209-210
Storage & Organization	334-341
Tags	342-343
Tiaras	363
Tweezers	180-192
Ultrasonic & Ionic Cleaning	3-9, 13-18
Vises	250-251
Watch Cleaning	13-21
Watch Parts Assortments & Crystals	377-425
Watch Repair Tools & Supplies	63-120
Watch Straps & Bands	426-434
Watch Testing	63-71
Watch Winders	364-365
Waterproof Testers	69-71

Full alphabetical and SKU # index at back of catalog.



Cas-KerCo.

Our complete Jeweler's Workshop has everything you need to start creating and repairing jewelry. Save \$300.00!

Number	Item	Value
110.000	Silicone Polishing Assortment	\$36.70
131.071	Jeweler's Bench	\$399.00
130.133	Dazor Bench Lamp	\$249.00
130.300	Bench Pin	\$4.25
140.001	Little Torch Kit	\$145.95
150.272	Stacking Watch Tray	\$11.50
160.600	Soft Brushes	\$10.75
171.554	Yellow Muslin Chemkote Buff	\$7.75
171.581	Muslin Buff with Shellac Center	\$3.25
171.775	Combed Finex Muslin Buff w/ Leather Center	\$5.25
180.153	Busch Cup Bur Assortment	\$36.00
180.155	Busch Hart Bur Assortment	\$39.95
220.668	Magic Luster Ultrasonic Concentrate 1 Gallon	\$20.50
230.091	L&R 2 Quart Ultrasonic Cleaning Machine	\$289.95
280.502	Twist Drill Assortment	\$29.95
290.474	OptiVisor	\$54.95
311.030	Barrette File	\$32.75
311.130	Half Round Ring File	\$44.50
311.146	Flat Hand File	\$23.50
330.981	File Cleaner	\$9.50
340.611	Flex-Shaft Hanger	\$20.50
341.300	Grobet Flex-Shaft Kit	\$99.00
350.998	Digital Caliper	\$43.95
351.260	Ring Sizers	\$13.50
351.558	Diamond Gauge	\$17.90
370.530	Brass Mallet	\$6.55
370.702	Rawhide Mallet	\$21.50
430.077	Grooved Ring Mandrel	\$29.95
450.300	Pickle Pot	\$27.50
460.803	Side Cutters	\$19.25
460.806	Chain Nose Plier	\$11.95
460.809	Flat Nose Pliers	\$11.95
461.118	End Cutters	\$44.50
470.461	Red Rouge 1/4 lb	\$3.25
471.479	Tripoli 1/4 lb	\$3.95
471.312	Fabulustre 1/4 lb	\$5.55
480.230	Ring Holding Tweezers	\$3.95
480.352	Ring Sizer	\$199.95
481.125	Ring Clamp	\$8.95
490.002	Sawblades	\$5.50
491.703	Sawframe	\$17.95
520.002	Screwdrivers	\$6.95
530.144	Prong Lifter	\$11.95
540.095	Third Hand	\$9.75
540.506	Black Magic Pickle	\$29.95
540.930	Solder Pick	\$4.95
541.210	Solder Board	\$31.95
541.404	Flux	\$7.70
570.0398	Head & Shank Tweezers	\$8.95
570.052	Copper Tongs	\$5.75
571.850	Utility Tweezers	\$11.25
581.240	Pin Vise	\$8.25
590.012	Spring Bar Tool	\$4.25
590.047	Case Knife	\$6.95
590.090	JAXA Style Case Wrench	\$16.50
340.346	Energizer Battery Tester	\$10.95
130.500	Complete Jeweler's Setup Total Value	\$2,250
	Your Cost	\$1950.00

Cas-Ker cleaning systems give you more power, more features, more ultrasonic strength.

These systems represent the most advanced technology in ultrasonic cleaning. Machines offer increased power for greater cavitation, more standard features and they are backed by L&R's exclusive "Double Warranty". The entire unit is covered for defects in materials and workmanship for 2 1/2 years. Both units are manufactured with only the highest quality components available.

Q140 - 3³/₈ Qt Ultrasonic

Powerful three quart unit sets the standard in ultrasonic cleaning, providing cleaning cavitation you can see.

- Timer and Heater. On-off switch and pilot light.
 - Stainless steel multi-position drain and plastic cover.
 - Overall: 10³/₈" x 6³/₈" x 8". Weight 9 lbs.
 - Tank Internal: 9³/₈" x 5³/₈" x 4" deep.
 - Tank Capacity: 3³/₈ quarts.
 - 0.8 Amp, 95 Watts, w/Heat 150 Watts.
- Peak Output 270 Watts, 43Khz.



230.140

230.140 L&R Q140 Ultrasonic with Timer & Heater **\$407.95**

230.405 Plastic Drain Hose Clip - Tubing Control Valve **\$5.50**

230.908 Drain Hose Assembly for Q140 w/Hose Clip **\$28.95**

230.909 Replacement Cord for L&R Ultrasonics **\$13.50**

Cas-Ker/L&R 2 Qt Ultrasonic

This two quart cleaning system offers efficient, trouble-free cleaning for a variety of ultrasonic energy jobs.

- Lighted on-off switch. Electric timer and heater.
 - Stainless steel housing, tank and cover.
 - Contemporary design and quiet operation.
 - Compact overall dimensions: 6⁷/₈" x 6³/₈" x 8⁷/₈". 8 lbs.
 - Tank internal dimensions: 5⁷/₈" x 5³/₈" x 4" deep.
 - Tank Capacity: 2 quarts.
 - 0.5 Amp, 55 Watts, w/Heat 150 Watts.
- Peak Output 160 Watts, 43Khz.



230.091

230.091 2qt Ultrasonic **\$289.95**

230.931 Replacement 2AMP Fuse for L&R Q90, 230.091 **\$8.50**

Timer Assembly & Knob

230.930 Timer Assembly 30 Minute for L&R Ultrasonics **\$47.95**

230.920 Timer Knob for L&R Ultrasonics **\$12.75**

Fabulustre 1.5 Pint Ultrasonic Cleaner

This ultrasonic heats up rapidly, operates quietly and provides the power you need to get the job done effectively. It features a heater and timer which allow you to pre-set the temperature and time for maximum cleaning results.

- Touch-sensitive control buttons require only slight pressure to respond.
- Water temperature and cleaning time settings are stored in memory until the unit is unplugged.
- Heater with actual water temperature display.
- Tank dimensions: 6"L x 3¹/₂"W x 2³/₄"D.
- 1.5 Pint Tank Capacity.
- Timer with minutes display.
- Stainless steel tank and cover.
- 110 Volt/60Hz with detachable power cord.



231.640

Baskets & Accessories on pages 8-9

231.640 **\$174.95**



GEMORO JEWELRY CLEANERS FOR SHOP AND HOME



230.171

2.6 Quart Heated Ultrasonic Cleaner with Digital Timer

Extra capacity of 2.6 quarts ideal for most retail jewelers.

- Advanced digital control system with heater and timer.
- Dura-last transducers. Evaporative resistant tight cover.
- Stainless steel 2.6 quart tank measures 10½" x 5¾" x 3¼".
- Removable stainless steel basket.
- One year limited warranty.

230.171

\$132.95



230.170

1.2 Quart High Performance Ultrasonic

• 5 working cycles for enhanced cleaning efficiency and ease of operation. Digital LED Display.

- High Performance Transducers for more cleaning power.
- Ideal Capacity - 1.2 Quarts/140ML. Tank size 6½" x 5¼" x 2½".
- Perfect size for retail jewelers, dentists, opticians and others.
- Stainless steel tank with removable plastic basket.

230.170

\$73.50



230.905

1.5 Pint Sparkle Spa Pro Personal Ultrasonic Cleaner

- Approximate 25oz (1.5 pint/750ml) tank capacity
- 5 Cleaning cycles 90, 180, 280, 380 and 480 seconds.
- Safely cleans most jewelry using regular tap water (for best results use GemOro Sparkle Pak solution).
- Digital timer. Auto shut-off function.
- Stainless steel tank. Auto-opening evaporation-free cover.
- Removable basket and bracelet/watch holder included.
- One Year Limited Replacement Warranty.

230.904

\$59.95



230.904

1 Pint GemOro Sparkle Spa ~ Personal Ultrasonic

- 1 Pint/600ml Capacity. 35Watts-50/60HZ.
- Uses water or optional cleaning solution to remove dirt & grime from rings, eyeglasses, jewelry and more.
- Bright Blue LED Illuminated Stainless Steel Tank.
- 42,000 Energy Producing Sound Waves Per Second.
- Electronic Pushbutton Timer with Auto Shut-Off.
- Removable Basket included. One Year Warranty.

230.905

\$36.95



230.045

GemOro Next-Gen 3 Quart Ultrasonic

Two intense cleaning powers at the flip of a switch: Turbo Sweep Technology® for the toughest jobs and Power Sweep Technology® for more delicate jewelry. The exclusive Instantaneous Digital Degassing "IDD" speeds up the cleaning process and Automatic Load Self-Tuning "ALST" constantly adjusts to maximum cleaning output and load voltage to maintain consistent cavitation and cleaning, regardless of load and liquid levels. Comes with stainless steel baskets and locking tweezers.

- Tank: 9 1/2" x 5 1/2" x 4" Capacity: 3-Quart / 0.75 Gallon Weight: 9 lb
- Basket and stainless steel locking tweezers included.
- GemOro super high-performance industrial strength transducers
- Adjustable thermostat temperature control
- Dura-Heat™ Long-life built-in heater
- 0-60 minute timer
- External fuse for easy access
- Smart Service – All plug & play electronics for fast repairs
- Best warranty on the market: 2.5 years on the unit and 10 years on the transducer.

230.045

\$339.95



LaSonic® Supreme Sonic Wave from Connoisseurs®

This cleaner offers modern technology and remarkable convenience. Independent sonic wave transmissions create more cleaning power safely and effectively. Every bit as safe as always, just more effective sonic wave action for better cleaning. Removable tanks let you empty and clean tanks with ease and without mess after each use. Lid storage compartment lets you store a lint-free drying cloth (included) or a polishing cloth. Space saving cord storage lets you wrap the cord conveniently underneath the machine.

230.185 **\$32.95**



230.185



BLITZ® Ultra Jewelry Cleaning Machine

- Twin Tank Design. One for cleaning, one for rinsing.
- Electric, UL approved. Measures 8" x 5" x 4½" overall.
- Two Cleaning Cycles. One for gentle, one for vigorous cleaning.
- Basket with ring holder and Brush for intricate cleaning.
- 4 oz. Gem & Jewelry Cleaner Concentrate.
- 4 oz. Delicate Gem & Pearl Cleaner and Polishing Cloth.

230.805 **\$26.95**



230.805

Connoisseurs® Sonic Jewelry Bath

Cordless cleaner uses sonic wave action to professionally clean jewelry at home. It features a carousel and suspension hook to hold jewelry for hands-free cleaning. Elegant, compact and easy to use. Includes a packet of cleaning solution and instructions. Requires 4 AAA batteries, not included. Measures 4¼"W x 5"H x 1½"D. One year warranty. For best results use Connoisseurs® brand premixed or concentrated cleaning solutions (not for use with silver jewelry cleaner).

230.180 **\$15.25 ea 6 @ \$13.75 ea**



230.180

Sonic Dazzle Stik

Sonic Dazzle Stik is a convenient jewelry cleansing power brush. Makes products look like they were cleaned by a jeweler. Includes advanced jewelry cleansing gel and silver jewelry cleansing formula with exclusive tarnish control.

230.054 Dazzle Stik **\$23.95**

230.052 1 oz. Advanced Gel Refill **\$4.75**

230.053 1 oz. Silver Refill **\$4.75**



230.054

Sonic Dazzle Drops

Advanced formula makes a fresh solution every time so your jewelry is cleaner than ever before.

- Enough for over 80 (10drop) cleanings
- Easy to use dipping scoop now holds more jewelry
- Easy-grip cleansing brush for all jewelry surfaces
- Cleansing container conveniently stores brush, scoop and drops

230.055 Dazzle Drops Advanced **\$5.95 3@ \$5.25 each**

230.055

230.056

Cleans, polishes and protects silver jewelry from tarnish.

- Includes soft cleansing brush specialized for all silver surfaces
- Easy to use dipping scoop now holds more jewelry
- Rinsing container conveniently stores brush, scoop and drops

230.056 Dazzle Drops Silver **\$5.95 3@ \$5.25 each**



The safe way to clean jewelry and gemstones.

Made in USA.



230.653

SPEED BRITE gives you brilliant results FASTER than polishing!



230.650



230.104

230.662

230.661

230.666



230.667



230.625

Speed Brite Systems feature:

- Not an ultrasonic - no damaging sound waves.
- Soft bubbles do the work - cleans pores in metal.
- No heat, ammonia or acid.
- Automatic Time Control - Cleans in 30 to 60 seconds.
- Meets O.S.H.A. standards.
- Safely clean gold and silver, as well as soft stones such as emerald, opal, turquoise and pearls.
- Eliminates tarnish.
- Superior Degreasing - A must for preplating.

SPEED BRITE Shop Model

The shop model inside tank measures 8 1/2" x 2". Includes lid, stainless ring bar, screen and 32oz Gem Sparkle concentrate.

230.653

\$169.95

SPEED BRITE 200SP Turbo Counter Model

Vibrating motor helps circulate dirt and tarnish away from jewelry faster. Fast, efficient, safe cleaning at the counter for walk in customers. Instant oxidation removal from gold and instant tarnish removal from silver. Includes 32oz Gem-Sparkle concentrate cleaning solution, Ring Hanger Wire and Stainless Steel Basket.

5-3/4" x 6-3/4". 12 oz. Capacity. 110 Volt. One Year Warranty.

230.650 Speed Brite Counter Model w/32oz Solution **\$134.95**

230.665 Extra Ring Holding Wire **\$3.75**

Gem-Sparkle Concentrated Solution does it all

Odorless and environmentally safe, this solution is an effective, fast-acting degreaser which also removes oxidation and brightens metal to a like-new finish. Acts as the electrolyte in the ionic cleaning process, and can be used repeatedly before it needs to be replaced. Dilute one part Gem Sparkle to six parts water.

230.662 One Gallon **\$34.95**

230.661 32oz Refillable Dispenser **\$23.95**

230.666 Dry Powder Crystals w/ empty 32oz. Dispenser **\$20.95**

Cannot be shipped by air.

Stainless Steel Cleaning Basket

Perforated basket fits Speed Brite Shop Model 230.653. Measures 8" x 4" x 2" not including handles.

230.667

\$36.75

High Speed ionShine cleans in 60 seconds

Cleans most jewelry in 60 seconds. Safe for precious stones, it will not harm opals, pearls, turquoise or other soft stones. The ionShine is especially good for silver jewelry because it leaves the surface tarnish-free. Just rinse, wipe and you're done. Gentle, powerful, fast, safe and simple to use. Removes oxidation and brightens metal. Measures 7" x 7". Capacity 12 oz. Complete with 16 oz. biodegradable super concentrated solution.

230.625

\$99.95

Best Built Ultrasonics

These powerful machines use short ultrasonic wavelengths to clean the finer aspects of jewelry, with enough power to remove caked on dirt and other compounds. Industrial strength transducers are the heart of these units. Reliable switches and rheostats. All Best Built Ultrasonics have heat and thirty minute timer. 2 year Warranty on transducers; 1 year overall.

2 Quart Best Built Ultrasonic

- Capacity: 1.8L / 0.48 Gallon.
- Tank size: 5.9" x 5.3" x 3.9". Unit: 7" x 6.4" x 8.3".

230.430

\$289.00

3.48 Quart Best Built Ultrasonic

- Capacity: 3.3L / 0.87 Gallon.
- Tank size: 9.4" x 5.5" x 3.9". Unit: 11.7" x 6.4" x 9.8".
- Heater with Variable Temperature Control & 30 minute Timer.

230.330

\$409.00

23.25 Quart Best Built Ultrasonic

- Capacity: 23.25 Quarts / 5.81 Gallons. Side drain.
- Tank size: 19.7" x 11.8" x 5.9". Unit: 23.6" x 13.77" x 12.4".
- Heater with Variable Temperature Control & 30 minute Timer.

230.411

\$1490.00



230.330

230.430



230.411

Elmasonic EASY 4 Quart Ultrasonic

The easy way to clean. Simple, user-friendly operation. Pulse function increases ultrasonic power up to 20%! User-defined temperature limit warning prevents high temperature damage to sensitive items. Sweep function ensures an even sound field distribution and an even removal of soiling. 37kHz.

231.673

\$629.00

The ElmaSteam 4.5

The powerful Elma steamer uses a combination of pressure, speed, and temperature to provide jet steam cleaning - safely and effectively. Two chamber design, 4 liter tank volume. Fixed nozzle. 4.5 Bar operating pressure, 65 PSI. 3 year warranty. 16.5" x 12.5" x 10"

241.990

\$1295.00



231.673



241.990

Brilliant Spa® Black Diamond Personal Steam Cleaner

Large 1-pint capacity steamer lets you may clean your entire collection of jewels and more with ease.

- Professionally cleans diamonds, gold, silver and platinum.
- Powerful steam cleaner safely generates a robust 50PSI of pressurized steam using regular tap water.
- Removable cleaning / drying basket.
- Portable, with easy-lift handles and durable construction.
- Includes jewelry holding tweezers, basket, steam residue mat and water funnel with measuring fill cup.
- Complements sister product: GemOro Sparkle Spa Pro® Personal Ultrasonic Jewelry Cleaner.
- Designed in the USA with European influence.
- Built for safety - ETL Listed.
- 2 Year limited replacement warranty.

230.810

Jewelers' Cost \$99.95

Attractively consumer packaged for resale at \$119.00

FOR CONSUMER HOUSEHOLD USE ONLY

230.810



GemOro



230.603



230.604



230.614



230.618



230.615



230.599

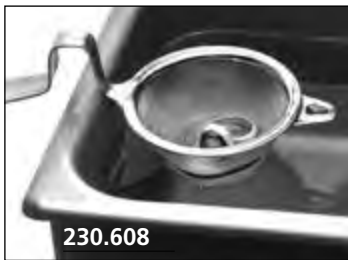

230.608



230.616



230.611



230.610



230.607

Double Poly Coated Ultrasonic Rack

Stands up or hangs in ultrasonic machine. Poly coated.

8"W x 4½"D x 4"H

230.603

\$10.50

Eight Ring Ultrasonic Rack

Poly coated rack hangs on top of your ultrasonic cleaner. 7" long.

230.615

\$4.50

Stainless Steel Ultrasonic Ring Rack

Stainless steel single rack hangs on sides of ultrasonic cleaner.

7¾" x 4½"

230.614

\$7.75

Poly Coated Ultrasonic Ring Rack

Small rack stands or hangs in ultrasonic machine. Poly coated.

8"W x 4½"D

230.604

\$4.50

Standing Stainless Ring Rack

Sits on the bottom of your cleaner and has eight hooks for safely holding rings and other items. Stainless steel, 6½" high x 3" diam.

230.618

\$9.75

Standing Basket

Ideal for cleaning jewelry in your ultrasonic. Fine mesh screen on plastic frame measures 4⅞" diameter x 4" high. Eight hooks protect all types of jewelry and allow for thorough cleaning.

230.599

\$29.95

Bend-To-Fit Basket

Strainer with metal handle may be used normally or the handle can be bent as shown to hang onto the side of your ultrasonic unit. Since the edge thickness varies on different ultrasonics, you can do the bending to your liking with pliers. Basket diameter 2".

230.608

\$4.50

Clip-on Ultrasonic Basket

Stainless steel basket clips securely on to the side of your ultrasonic machine. Fine wire mesh suspends the smallest parts and jewelry for a thorough cleaning. Measures 5" x 4" to fit 2 quart and larger machines.

230.616

\$14.25

Ultrasonic Baskets

Baskets speed the cleaning process by suspending jewelry in the solution for the most effective cleaning possible. Stainless steel.

230.610 5" x 5½" for 2qt Ultrasonic

\$38.75

230.611 5" x 8¾" for 3¾qt Ultrasonic

\$43.95

230.607 5⅝" x 2½" small

\$13.95

Nylon Mesh Basket

4" x 3" x 2¼" basket with 6" handle and hooks. The plastic frames and nylon mesh make this perfect for suspending precious jewelry safely while in your ultrasonic.

230.601 **\$6.50**

Stainless Steel Basket

Keeps small parts, findings and stones together. The basket will not affect the items or the solution. Spring handle applies firm pressure to stay closed when in use. Handy for steam cleaning too.

230.620 **\$4.95**

Ultrasonic Bar Rack with 8 or 12 Hooks

Versatile cleaning rack with movable hooks is made of non-rust aluminum. The double hooks are plastic and can be moved along the rack for the best positioning of items being cleaned. The neat part is that these cleaning racks fit all tanks! Great for chains, ring, etc. Replacement hooks also available.

230.631 Rack with 8 hooks 11¾" long **\$5.25**

230.633 Rack with 12 hooks 14¾" long **\$7.25**

230.632 Replacement Hook **\$1.00 ea 12@ \$0.85 ea**



230.601



230.620



230.633

Replacement Tips for Steamostats

460.0139/1 Replacement Tips **\$1.75 pr**

Grobet Steam Tweezers

Used to hold item while steaming.

571.01400 Spring grip 9½" long **\$8.75**

571.01401 Spring grip 6" long **\$8.95**

Large Steaming Tweezers

Extra large tweezers have plastic coated tips for steaming. Also for pickling and ultrasonic cleaning (non-scratch retrieving), etc.

570.921 8" long Grobet **\$5.50**

570.922 12" long (India) **\$5.50**

Large Steaming Tweezers with long Lasting Tips

German made 8" tweezers have non-marring plastic coated tips for steaming. Also for pickling and ultrasonic cleaning, etc.

570.963 **\$19.95**

Cross-Lock Coated Forceps

Plastic coated tips, nickel-plated steel, cross-lock tweezers hold item securely. 6½" long.

571.777 **\$12.90**

Wooden Steaming Tweezers

Large grooves in these handy tweezers hold a variety of items for steam cleaning. Non-marring wood won't conduct heat, keeping your hands safe. 8" long.

570.924 **\$5.75**

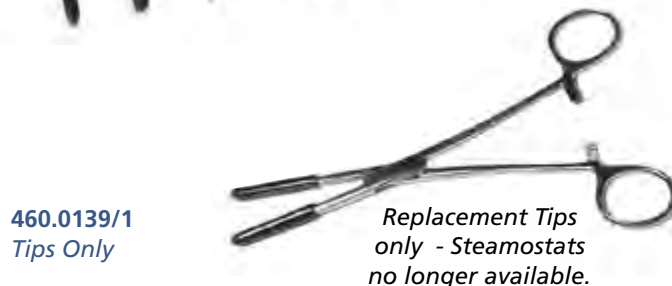

460.0139/1
Tips Only

Replacement Tips only - Steamostats no longer available.



571.01400



571.014011



570.921
570.922



570.963



571.777



570.924



230.789



Made in USA

Hoffman JEL-3 Steam Cleaner

Hoffman/New Yorker JEL-3 Steamer is truly top quality. Hoffman manufactures the most used, trusted and reliable steamers available . . . since 1904! Designed and made by the same people who invented jewelry steamers. Hoffman steamers have been proven as the ideal choice for the jewelry industry, dental labs, precious metals, eyewear, crystal industries, surgical labs, and clean room applications. Grease, grime and micro-deposits disappear in seconds. Oxidation and deposits are removed from the tiniest crevices for a bright, sparkling finish. Features include:

- Compact stainless steel cabinet, 17" x 19" x 26". Weight: 85 lbs.
- Exclusive coated tank to prevent rust!
- Large easy to read PSI gauge and sight glass.
- Develops 70-90 PSI steam. Continuous steaming and pressure.
- No special plumbing or wiring required.
- Quiet steam jet.
- Complete cleaning guide included.
- Long life heating element.
- ASME approved, UL listed.
- Made in the USA. One year warranty.

230.789

\$1350.00



230.797



Made in USA

Hoffman GEM-111 Steam Cleaner

Boilerless Atmospheric Steamer requires no boiler permit. Portable, economical, versatile and reliable. Model GEM-III is an explosion-proof, boilerless, high pressure atmospheric steam cleaner tested and approved by national retail chains, dental labs and laser surgical centers.

- No boiler permits required. Approved for all Shopping Malls.
- Foot pedal control provides hands-free operation.
- Fast heat-up time. Dual heating elements.
- Automatic pump and motor. Automatic safety release valve.
- User-friendly and maintenance-free. Low noise level.
- Rugged rust resistant stainless steel cabinet.
- Portable with strong durable handle.
- 85-90 PSI
- Compact size: 9"W x 14"D x 13"H.
- Shipping Weight 24lbs. Additional shipping charges apply.
- Ground shipping only to the 48 continental US states. No overnight air shipment.

230.797

\$779.50



Steam Cleaner Additive

Prevents calcium build-up in your steam cleaner, and also cuts down on scaling and unwanted mineral deposits.

230.900

\$7.75

Cannot be shipped by air.

Compact atmospheric cleaner produces 60-90 p.s.i. dry steam instantly on demand

Silver Dragon

The Silver Dragon encompasses the latest improvements in steam cleaning technology. With a push of the foot pedal, The Silver Dragon gives you bursts of steam strong enough to clean the toughest dirt, yet dry enough to clean jewelry in your display trays without harming tags.

- Minimum maintenance.
- **Uses distilled water only!** For best results use deionized or steam distilled water if available.
- 20 Gauge Stainless steel cabinet.
- Foot pedal control.
- 10 minute heat-up time.
- One year warranty.
- 1300 watts / 11amps.
- Over 125 psi.
- Weighs only 20 lbs.
- Easily portable - 12" x 9" x 10"H.
- State of the art safety features - including temperature and pressure limit controls.
- Safe for stores and malls. Ideal size for showroom counter.
- Made in USA. Ships via UPS.



230.850



230.850	Silver Dragon Steam Cleaner	\$725.00
231.719G9	Foot Pedal	\$34.95

Rugged construction, simple operation and minimum maintenance makes the Silver Dragon an ideal choice for jewelers.

The Reliable i500A is ideally suited for the jewelry store, producing 50 PSI of cleaning power

The i500A produces 50 PSI of steam pressure and reaches temperatures up to 221° F at the tip. Ideal for the jewelry store or workshop for cleaning away left over wax, plaster waste and other debris, and for polishing the final product. Steam deodorizes and sanitizes with heat and moisture and since the only ingredient required for the i500A is water, cleaning has never been safer, healthier or more environmentally friendly.

Features:

- 0.66 gallon, 2.5 L water capacity.
- **Uses regular tap water!**
- Low water light indicator.
- 1000W heating element.
- 10-15 minute heat up time.
- 12-gauge heavy-duty wiring.
- 50 PSI, 3.5 bar operating pressure.
- Stainless steel tank and outer casing.
- Copper heating element.
- Handy carrying handle.
- Low water light indicator. Water level stick.
- Up to 4 hours of continuous steam and 8 hours of use per day.
- Made in Italy. Limited One Year Warranty.



Outstanding design and dedication to quality. 100% stainless steel. Made in Italy.



230.825

230.825	Reliable i500A Steam Cleaner	\$575.00
230.826	Heating Element for Reliable Steamer i500A	\$94.50
230.827	Teflon Ring for Reliable Steamer i500A	\$8.50
230.828	Safety / Filler Cap for Reliable Steamer i500A	\$31.50



4 SAFETY SYSTEMS
The i500A has 4 safety systems, including a pressure switch, probe safety thermostat on the heating element, safety cap with safety valve, and a low water indicator.

PRESSURE GAUGE
A pressure gauge is standard on the i500A. It gives you a constant, visual indicator of the internal boiler pressure.

ACCESSORY KIT
Each i500A jewelry steam cleaner comes complete with a water funnel and a water level measurement stick.

Reimers® 2.0 Gallon Steam Cleaner

ELECTRA STEAM, INC.



Made in USA

230.777

Steam cleaning is the fastest, most efficient and economical way to give your jewelry that extra sparkle, resulting in higher sales. Reimers Cleaners are the finest in the industry - engineered for many years of trouble-free service.

Built in USA since 1908. Reimers' outstanding features:

- Flexible steam nozzle positioning.
- Hand filled through inlet funnel.
- Detachable solenoid valve easy to replace.
- Air foot switch for safe operation in wet environments.
- Easy access to element and pressure controls.
- Large tank produces high quality, clean steam and assures long periods of uninterrupted service.
- Easy gauge glass replacement. Glass has clear protective cover.
- 5 lb of steam power per hour; Pressure Range 5-85 PSIG.
- Pressure control with high limit instead of thermostat for added safety (to meet stringent CSD-1 regulations of ASME code). You must hit reset button if high pressure control is activated.
- Modern stainless steel cabinet. Dimensions: 12" x 17" x 16".
- Weighs 62 lbs. Ships via UPS (69 lbs.)
- Components mounted for easy access, manual reset low-water cut off.
- One year limited warranty. Customer is responsible for shipping costs when returning machines for any repair.
- All boilers are built in accordance with the requirements of ASME Section I and CSD-1, U.L. Listed and National Board inspected. Each unit is steam tested at the factory.

230.777

\$1475.00

Reimers Replacement Parts

Repairs must be done by experienced personnel. Steamer must be cold, drained, de-pressurized and unplugged before repairing.

230.700	Solenoid Valve - Reimers Jr.	\$193.50
230.702	Safety Valve, Reimers or Hoffman NY Jel 1/3	\$187.50
230.707	Brass Nut for water gauge fixture set for new style Reimers	\$3.95
230.609	Gauge Glass Kit for JR Serial #66141 and up. 5"	\$68.95
230.619	Thermostat/Heating element assembly	\$249.00
230.709	Gauge Glass, Reimers #55642 and up. 0.625"x5"	\$28.95
230.710	Sight Glass for Serial #21522 & up . 7/4"	\$28.95
230.711	Pressure Control #04163 for 230.777 Steamer	\$97.50
230.766	Hand Wheel/Black Knob for 230.793 H2O Gauge	\$8.50
230.769	Foot Controller for Reimers Junior Steamer	\$86.50
230.771	Sight Glass for Serial 8 1/2" #21521 & below	\$28.95
230.772	Pair Rubber Washers	\$4.50
230.774	Heating Element/Gasket for new style Steamer	\$111.50
230.775*	Steam Release Valve for older models only	\$70.95
230.778	Heating Element	\$153.95
230.780	Thermostat & Gasket	\$149.95
230.781	Whistle Valve	\$85.50
230.783	Brass Gauge Washer (set of 2)	\$4.50
230.784	Valve Ball	\$47.25
230.786	Safety Shield for Sight Glass	\$62.95
230.787	On/Off Switch for 230.777	\$22.95
230.788	Gauge Set Valve Repair Kit	\$30.25
230.793	Water Gauge 2 pc Set (Hand Wheel 230.766)	\$97.50
230.794	Reset Switch & Wire Relay	\$28.95
230.795	Gauge Protector for Reimers 5" Sight Glass	\$54.50
230.796	Valve Ball w/Slide Lock (Blow Down/Drain Valve)	\$46.25

Hoffman/NY Replacement Parts

230.701	Glass Gauge Fixtures	\$61.50/2
230.779	Steam Release Valve	\$109.95

Sight Glasses

Sight glasses must be replaced annually as the walls thin with normal usage. Always use new seals when replacing glass.

No.	Size	Model	Price
230.710*	7"	Grobet 23.708 & 709, Vigor CL870B, Reimers Jr. Serial #21522 & up, Steamaster SMJ Oct #705	\$28.95
231.726G*	7"	Grobet 23.720G	\$16.40
230.770	7 1/4"	Hoffman-New Yorker, JEL-1/JEL-3	\$22.50
230.771	8 1/2"	Reimer Jr. Serial #21521 and below	\$28.95
230.772		Pair Rubber Washers	\$4.50
241.913GL*		Sightglass 6" w/2 Rubber, 2 Brass Washers	\$9.40

*Supplied with washers

GemOro Steamer Part

230.602	Gasket for X-Steam Black 3/4" Outside Diameter	\$1.75
---------	--	---------------

Steaming Tray catches stones

Steel tray has a fine mesh screen to catch any stones that may loosen from jewelry while steam cleaning. Sets flush to bottom of your Reimers steam cleaner.



230.773

\$39.95



590.949

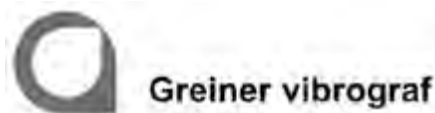

ACS 900 Ultrasonic Watch Cleaning Machine

Fully automatic and programmable machine cleans up to 15 watch movements, assembled or disassembled in a mesh basket. ACS 900 features ultrasound for cleaning in one position, adjustable time and spin for each position and a separate position for heated blow drying. Computer operated cleaning program can be stored in memory. Includes standard accessories - four jars for cleaning and rinsing. A wide variety of baskets are available.

Shipping Weight 70lbs.

590.949 Watch Cleaning Machine w/ Ultrasound	Call*
230.040 Replacement Glass Jar 6 ⁷ / ₈ " x 4 ¹ / ₄ " Diameter	\$56.75

*Call for competitive quotation.

MATADOR 4000 - The ultimate in manual watch cleaning machines.



Ultrasonic transducer and variable speed and temperature dryer.



THE MATADOR 4000 by Lititz Precision Products ultrasonic watch and small parts cleaner is the ultimate in manual watch cleaning machines. The unit consists of four stainless steel cleaning/rinsing cups with one movable ultrasonic transducer head and a variable speed/variable temperature dryer. It uses Small 8 oz. cups for economical cleaning solution utilization. The microprocessor controls all machine functions including dryer, ultrasonic head, and the dual timers.

Specifications:

- Four wash/rinse stations.
- 8 ounce (.06 liter) cup size.
- Ultrasonic Timer and Dryer Timer.
- Variable speed dryer 200-1000 RPM.
- Variable temperature dryer.
- Audible alert when cycle is finished.
- Languages: English, Spanish, French, German.
- External jack for 24 VDC ventilating fan.
- Dual ball bearing dryer.
- Brushless dryer motor for long life.
- Microprocessor controlled.
- Four line digital display.
- 120 Volt.
- 16" Wide 10" Deep X 6" High.
- Weight: 16 pounds.
- Designed and manufactured in the USA.



Made in USA

590.874

\$2999.00

FREEDOM 55000

The affordable ultrasonic.

Freedom 55000 Ultrasonic from Lititz

The NEW Freedom small parts cleaner features five automatic-cycling ultrasonic cleaning/rinsing stations. Priced thousands of dollars less than similar machines, the Freedom's compact jars also reduce waste, saving you money on cleaning and rinsing solutions.

- Five ultrasonic cleaning or rinsing stations
- Ten user-customizable programs
- Powerful variable temperature dryer
- Programmable agitate and dry times
- Programmable agitate strength
- Audible beeper at end of cycle
- 4 x 40 character LCD display
- Lift-off index table for easy cleaning
- One year warranty

20 lbs. 16" wide x 27" high x 17" deep

Designed, manufactured, and assembled in the USA

590.985

\$7495.00



Made in USA

590.985



Dry your watch parts and jewelry without fear of corrosion, tarnish or loss of lubricants

Designed to work in conjunction with ultrasonic cleaning machines, making transfer easy. Simply place a cleaning basket on the special stainless steel grid and your items will dry quickly, efficiently and quietly.

- Reliable, economical, simple to operate, high drying power.
- Allows batch drying of several items at once.
- 10" x 6 1/8" x 4". Small enough to fit on a countertop.
- Lightweight and built for years of continuous operation.
- 117V. Plugs into a standard outlet.

230.500 L&R Parts Dryer **\$329.00**

230.009 Replacement Heating Element for 230.500 **\$82.95**

230.610 Ultrasonic Basket **\$38.75**



230.500

Use the L&R Dryer with optional # 230.610 Ultrasonic Basket for drying jewelry, watch and clock parts, machine parts and more.



*L&R is the worldwide leader in
Ultrasonic Cleaning Systems and Solutions.*

Extra Fine Watch Cleaning Solution

Provides the highest possible polish for watch parts. Formulated for mechanical watch cleaning machines where a more efficient cleaning material is needed.

230.062 Gallon **\$51.00**

#111 Ultrasonic Watch Cleaning Solution Ammoniated

For use with all L&R rinses and ultrasonic watch cleaning systems. Specially formulated ammoniated cleaner provides complete cleaning.

230.063 Gallon **\$53.00**

#566 Ultrasonic Non-Ammoniated Watch Cleaning

For use when ammonia fumes are unacceptable and for use with L&R #3 Rinse or L&R Ultrasonic Watch Rinsing Solution (Solo-Lube or Duo-Lube Process)

230.064 Gallon **\$57.00**

#3 Watch Rinsing Solution

This quick-drying solution is a clear, petroleum distillate specially-formulated by L&R chemists. It contains no benzol or chlorinated solvents and leaves no oily film.

230.065 Gallon **\$49.95**

Ultrasonic Watch Rinsing Solution

Ideal solution for ultrasonic cavitation. Can be used with all L&R watch cleaning solutions. Ideal with Duo-Lube and Solo-Lube lubricants. Fast-drying, will not break down.

230.066 Gallon **\$49.95**

#677 Ultrasonic Non-Ammoniated Clock Cleaning Solution

Developed to meet the heavier-load demands of cleaning clock movements. Ready-to-use, waterless and non-ammoniated.

230.076 Gallon **\$57.00**

Clock Lube Ultrasonic Lubricating and Rinsing Solution

Complete lubricating and rinsing solution. For use with L&R #677 Clock Cleaning Solution.

230.077 Gallon **\$63.50**

Clock Cleaning Solution Concentrate

This economical solution uses only a pint of concentrate to make a gallon of cleaning solution. Highly-effective for ultrasonic, mechanical or manual cleaning. A safe, water-based, ammoniated product. Contains no cyanide.

230.070 Gallon **\$66.00**

Free Shipping on Orders of Four Gallons L&R Cleaning Solutions

Orders must be in multiples of Four Gallons.

Solutions may be assorted.

No Hazardous Shipping Charges. Cannot be shipped by air.





Zenith Watch, Clock & Jewelry Cleaning Solutions

Environmentally friendly fluids can be used in both ultrasonic and standard watch parts cleaning machines.

Zenith 251 Watch Cleaning Concentrate

- Gentle solution recommended for antique watches and clocks.
- Water base ammoniated cleaner formulated for ultrasonic machines, mechanical and manual cleaning.
- Ideal for antique pocket watches and clocks that have protective coatings on their parts.
- Rinse with water and immediately dry in the heating chamber or blow dry (leaves a slight film if air dried).
- One gallon makes 8 gallons of cleaning solution.

230.0251G Gallon **\$43.95**

Zenith Radiant No.777 Watch & Clock Cleaner

High performance - cleans and shines delicate parts at the same time. Formulated to clean movements that contain alloys of beryllium, nickel, copper and zinc. Compatible with all Zenith rinsing solutions. Low odor. Use in ultrasonic or mechanical machines.

230.022 Gallon **\$44.50**

Zenith 101 Drizebrite Final Watch Rinse

- Designed to leave watch and clock parts spotless without any oily film when dried at room temperature or in a heating chamber.
- Restores delicate movements to their original luster after being cleaned with Zenith's Formula 67 or any solvent based cleaner.
- Odorless and can be used in old or modern cleaning machines.
- Meets with all watch and clockmakers requirements.

230.029 Gallon **\$41.95**

Zenith No.206 Formula 67 Watch Cleaning Solution

- Cleans both watch and clock parts and restores them to their original high polish surface.
- Contains penetrating solvents that break the bond between grease, oil and dirt from metal, resulting in perfectly clean parts.
- Ammoniated - Without Ammonia Fumes or Smell.

230.0206 Gallon **\$41.95**

Zenith Ultrasonic Watch Rinse

- Readily dissolves grease and oil after Formula 67 has removed them from the surface.
- Dries clean without leaving any film or tackiness on metal parts.

230.0224 Gallon **\$41.95**

Zenith Z-88 Non-Ammoniated Cleaning Concentrate

- Superior, very effective all purpose cleaner for jewelry and watches. Ideal for cleaning metal watch bracelets.
- A must for the polisher. Removes polishing compound residue.
- One gallon concentrate makes as much as 16 gallons solution.

230.0253G Gallon **\$34.95**

Zenith 249NA Non-Ammoniated Jewelry Concentrate

- Delivers excellent cleaning power and emits no harmful fumes.
- Ideal for jewelry with semi-precious and precious stones.
- Rated environmentally friendly and safe.
- Can be used in ultrasonic, mechanical and simple manual cleaning. Rinse with water and dry.
- One gallon concentrate makes 8 gallons solution.

230.021 Gallon **\$26.25**

Zenith 292 Dip-It Silver & Coin Cleaner

- Instantly removes tarnish from silver, silverware and cutlery.
- Ideal for coin cleaning. Just dip and rinse with water, wipe dry.

230.023 Gallon **\$29.95**

Free Shipping on Four Gallons Zenith Solutions.

Orders must be in multiples of Four Gallons. Solutions may be assorted. No Hazardous Shipping Charges. Cannot be shipped by air.

Zenith Hi-Tech Cleaner

Fast acting and aggressive cleaner is gentle enough not to remove lettering from baked-on enamel coatings. Hi-Tech dissolves lubricants twice as fast as any other cleaner. No ammonia fumes; safe and environmentally friendly. Use with Zenith Hi-Solv Rinse solution.

230.024 Gallon **\$43.95**

Zenith Hi-Solv Rinse

Rinse away debris and cleaning solution from watch movements. Restores original luster and shine. Use with Hi-Tech cleaner in ultrasonic or mechanical units.

230.025 Gallon **\$43.95**

GemOro

GemOro Super Concentrate Ultrasonic Solution

Removes grease, dirt, buffing compounds, rouge, tripoli and oxides from jewelry. May also be used to clean instruments, burs, metal parts, gold and fine jewelry. Excellent for ultrasonics, glass and general cleaning. Super Concentrate, non-ammoniated, no color additives, biodegradable, non-toxic and non-flammable. Gallon makes up to 40 Gallons Solution. Made in USA.

230.038 **\$21.95**

GemOro Sparkle Pak™

No Measuring. No Mixing. No Mess. No Waste.

Sparkle Pak™ is an innovative solution . . . for ultrasonic solution! Just empty a convenient Sparkle Pak into water in the tank. Professional strength specially formulated jewelry cleaning. Removes dirt, grease, buffing compound, rouge & oxides from jewelry & more. Non-ammoniated, non-toxic and non-flammable.

Sparkle Pak Cleaner for 1.5 Pint Ultrasonics or Sonics

230.015 10 Paks for consumer 1 - 1.5 Pt cleaners **\$9.95**

Sparkle Pak Cleaner for 2 Quart Ultrasonics

230.016 24 single dose Paks for 2 Qt mini cleaners **\$19.95**

Sparkle Pak Cleaner for 3 Quart Ultrasonics

230.017 24 single dose Paks for 3 Qt mini cleaners **\$29.95**

"Magic" Solutions

Magic Luster Super Ultrasonic Cleaner Concentrate

Super fast on rouge and tripoli. Industrial strength, no ammonia, bio-degradable. Simply add water up to a ratio of 40 to 1.

220.668 1 Gallon makes 40 gallons **\$20.50**

Magic Vanish Tarnish Remover

Safe on silver, gold, brass, and copper. Instantly removes tarnish from jewelry and flatware. No rubbing necessary - just dip and rinse with water.

220.680 Gallon **\$29.95**

Magic Green Concentrate

Long lasting space age ultrasonic concentrate. Cleans all precious metals, diamonds, precious, semi-precious stones, cz's. No Ammonia, fresh scent. Use 1 oz to gallon of water. Removes buffing compound and attacks tripoli instantly.

220.656 10 lbs makes 160 Gallons **\$75.00**

220.655 32 oz makes 32 Gallons **\$19.95**



230.024

230.025



230.038



230.015 - 230.017



220.668



220.680



220.656



220.655



230.032

Cas-Ker Non-Ammoniated Ultrasonic Jewelry Cleaning Concentrate

All purpose jewelry cleaner for safe cleaning of gold, base metal and diamonds. Can be used with ultrasonic cleaner and boil-out, or as dip, spray or soak. Mix as little as 1 part concentrate to 15 parts water for light cleaning. Rinses with water. USDA approved non-toxic, non-flammable, non-ammoniated and biodegradable. 1 gallon.

230.032

\$24.95



230.081

L&R Prep Clean Buffing Compound Remover

Effective water based cleaner for the removal of buffing and polishing compounds won't leave corrosion-inhibitor residue. Use with a heating unit if compound has a heavy wax consistency.

230.081 One Gallon

\$46.50



L&R Jewelry Cleaner Ammoniated Concentrate

L&R's most popular cleaner is strong and effective, with the added power of ammonia. Safe for use on gold, silver, diamonds and gemstones, adds sparkle and brilliance in minutes. 1 gallon.

230.079

\$42.50

L&R Non-Ammoniated Concentrate

The ideal solution for all jewelry cleaning without the added ammonia. Cleans safely and effectively and works magnificently on gold, diamonds and gems. 1 gallon.

230.082

\$43.50



230.074

230.073

230.079

Ellanar Dip Silver Cleaner

Instantly removes tarnish from sterling and most silver plate in seconds without rubbing. So effective that as soon as Dip is applied, the tarnish disappears. Simply dip, rinse and dry.

Cannot be shipped by air.

230.073 16 oz.

\$7.25 ea 12 @ \$6.50 ea

230.074 Gallon

\$39.00



230.080

Ellanar Silver Polish

Provides scratch-free polishing of silver while applying a safe, protective tarnish barrier. Even the most stubborn tarnish disappears magically upon application, protecting sterling silver for months at a time. Pleasant scent. Cannot be shipped by air.

230.080 12 oz

\$9.50 ea 12 @ \$8.50 ea



231.032

231.01857

Connoisseurs™ Jewelry Cleaner Concentrates

Specifically developed for sonic applications. Regular Formula for gold, diamonds and precious stones and stubborn soil. Delicate Formula for pearls, semi-precious stones, light soil. 8 oz bottle makes 1/2 gallon of solution. Consumer resale \$6.45.

231.01857 8oz Regular Formula

\$6.10

231.01910* One Gallon Regular Formula

\$28.95

231.01856 8oz Delicate Formula

\$5.75

231.01882* One Gallon Delicate Formula

\$26.95

Cannot be shipped by air.

Griffith INSTA-CLEAN Jewelry Cleaner

From Grobet USA™. Simply dip and rinse. Cleans silver, gold, copper and brass like new. 16 oz.

231.032

\$9.50

Polyimide Tape protects parts you don't want to polish

Cover areas of metal watch bracelets and cases to protect them while finishing and polishing. Simply apply this tape to bracelet links that are adjacent to the links you are finishing. Silicone adhesive tape in six widths to fit any size link. Rolls are 36 yards (1296") long.

Number	Width	Price	Number	Width	Price
640.701	1.0mm	\$13.50	640.706	6.5mm	\$18.25
640.702	2.0mm	\$14.95	640.707	7.0mm	\$21.50
640.703	3.0mm	\$15.25	640.708	8.0mm	\$22.50
640.704	4.0mm	\$15.50	640.709	9.0mm	\$22.50
640.705	5.0mm	\$15.95	640.710	10.0mm	\$23.50

Multi-Roll Tape Dispenser for Polyimide Tape

Use narrow tape and dispense one roll at a time, or use wide tape up to the width of the dispenser. Baked enamel heavy duty steel construction. Non-skid base. Holds tape with a 3" core and up to 6" total tape diameter. Holds tape with 3" core. Maximum Tape Size (outside diameter): 6" Maximum Width: 4".

640.000 **\$38.50**

BERGEON 7007-S Fabric Cleaning Swabs

Assortment of seven shapes for cleaning the smallest, most delicate parts. Knit or non-woven fabric heads are acid and solvent resistant. Sealed edges built in high strength with no loose fibers or particulates. Ideal for tough scrubbing around raised shapes. 140 pieces total with plastic handles. Swiss made.

640.7007 **\$86.50**

BERGEON Tapered Cylinder Polyurethane Foam Swabs

640.7007.04 Bergeon 7007-4 10 Pack **\$34.50**

Swabs for your most delicate cleaning operations

Swiss made high quality swabs are ideal for precision cleaning and applicator needs for the watch and clockmaker or anywhere a lintless application is required. Average 3" long. Assortment of 12 includes 4 different styles. Also available packs of 12 of one style.

110.400 **\$6.50/12**

Wrapped Foam swab delivers superior abrasion resistance for removal of tough contaminants. Wicks solvent from surfaces. Small tip allows use in very tight areas, the pointed end works as a pick.

110.401 **\$6.95/12**

Sealed Foam economical general purpose swab. Open cell structure gives the best solvent holding ability of any style swab. Free of adhesives or binders that could contaminate your process. Fiberless construction guarantees particle free.

110.402 Rounded **\$5.95/12**

110.403 Pointed Tip **\$5.95/12**

Sealed Polyester very clean and durable all-purpose swab. Acid and solvent resistant and ideal for tough scrubbing around raised shapes or delicate cleaning applications.

110.404 **\$5.95/12**

Texwipe CleanFoam® Swabs

Excellent for cleaning small slotted and grooved areas. Precision tip is especially useful for magnified or microscopic work. Laundered polyurethane CleanFoam® head. Compressed 100 ppi open-cell structure. Light green polypropylene handle. Thermally bonded head. Firm, nonabrasive tip. 2 5/8" long. 100 pieces.

110.500 **\$22.95**



Kapton® Tape

640.702 - 640.707



640.000



640.7007

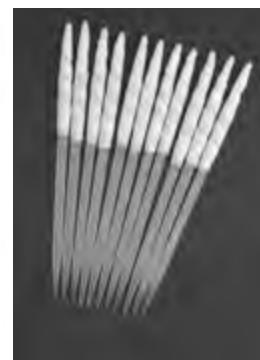

640.7007.04



110.401



110.402



110.403



110.404

110.400 Assortment - 3 each of above four Styles



110.500



420.601



640.7033



640.7040



420.603



100.742 -
100.744

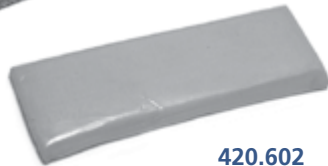
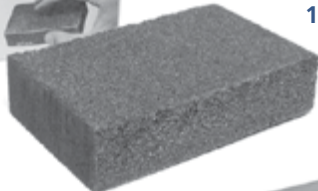

420.602



470.372

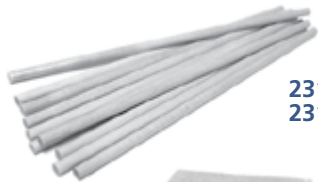

231.300
231.303



231.0530



230.305



230.336

Ivory Fingerprint Cleaner from ETA

ETA's Ivory cleaning product removes fingerprints from plates and other watch parts. Absorbs oils, leaving watch parts free of fingerprints and oil residue. Meets Swiss watch industry standards, and contains no chlorine.

420.601

\$14.95

Genuine Bergeon 7033 Rodico Premium

Approved by the highest quality watch brands, this product can easily be adopted by all new technologies that require very high-tech materials (silicium, carbon, diamond, etc.). Thanks to its highly absorption power, all finger prints, spots and sediments will be removed without any risk to the cleaned pieces. Single stick.

640.7033

\$5.75

Genuine Original Bergeon 6033 Rodico Dry Cleaner

Special watchmaker's cleaning product removes stains, surplus oils, loose dirt, grime, smudges and finger prints from precision parts. Also extracts broken pivots from jewels.

420.603

\$5.25

Bergeon Cleaning Wipes

Polypropylene wipes clean greasy pieces and surfaces. Contains 70% isopropyl and 30% deionized water. Disposable pack of 50. 230mm x 280mm.

640.7040

\$36.50

Genuine BERGEON 5444 Polishing Block

Flexible synthetic rubber block with abrasive powder for polishing, removing rust, cleaning, etc. Medium grit is excellent for refinishing Rolex brushed finish watch cases.

100.742 Bergeon 5444 A Fine \$23.50

100.743 Bergeon 5444 B Medium \$23.50

100.744 Bergeon 5444 C Coarse \$23.50

Genuine BERGEON 6807-EF Polishing Powder

High quality Extra-Fine Diamontine powder produces a final high lustre on parts and tools. 15 gram bottle.

470.372

\$8.50

Rub-Off Cleaning Compound

Watchmaker's compound removes stains, oils, dirt, grime, and finger prints from parts and extracts broken pivots from jewels.

420.602

\$4.25

Imported Pegwood

Selected orangewood for cleaning pivot holes and various other uses. 20 sticks in each bundle. 5³/₄" long.

231.300 2.0mm Diameter \$7.25

231.303 4.0mm Diameter \$10.75

Sawdust

Fine quality, guaranteed free from foreign substances. 1 lb. box.

231.0530

\$4.50

BERGEON 4749 PoliPivot Wood

King's wood (soft wood) for cleaning small parts and tips of oilers.

230.305 Box of 10

\$33.95

Bergeon 1586-S Pithwood Sticks

Bundle of 24 pieces natural pithwood for cleaning watch hands, dials and delicate parts. Assorted diameters 7-12mm, 4" long.

230.336

\$16.95

Famous Painting Microfiber Cleaning Cloths

Studio Hi-Look Cleaning Cloths are perfect for cleaning everything from eyeglasses, magnifiers, CD's, laptops, jewelry and watches. And they feature the work of the world's most famous painters. Assortment includes 24 cloths, 2 each of 12 different paintings in an acrylic display. Super fine 100% pure microfiber is safe on UV and AR coated and specialty lenses. Each 6" x 8" cloth is packed in a deluxe vinyl case. Cloths don't scratch or leave lint and are washable and reusable. Featured artists include Degas, Renoir, Van Gogh, Michelangelo and of course daVinci's Mona Lisa. Many other designs available - call for brochure.

170.089 24 Piece Display 6" x 8" Cloths	\$78.75
170.091 Individual 6" x 8" Cloths	\$3.95 ea
Two each of 6 different designs	\$37.95 dz



170.091

Ultra-Polish Pads for an amazingly fast high luster

Fast and easy, convenient sized 2" x 2" hand polishing pads are great for removing tarnish, highlighting when using liver of sulphur or silver black, or polishing to a high luster. Leaves no residue. Made of thin, tight-bond foam with permanently bonded micro-abrasives. An economical polisher that is truly amazing.

170.096	Pack of 20 \$7.25
----------------	--------------------------

170.089

170.096

SILVEX® Gold and Silver Repair Polish

4-in-1 polish concentrate cleans, polishes, seals and removes minor scratches from gold and silver jewelry. Includes 25g/0.88oz. concentrate, a polishing cloth and microfiber cloth.

470.500	\$13.25
----------------	----------------



230.630



470.500

Biodegradable Organic QuikBrite Jewelry Cleaner

QuikBrite contains enzymes to remove all body oils, debris and grime accumulated on all jewelry and stones. Safe, fast and easy to use. Simply spray a mist onto jewelry, allow to set and wipe off with a clean cloth. Will not harm precious stones. Non-toxic, contains no ammonia or harmful components. 2 oz.

230.630	\$1.95
----------------	---------------



470.501

Gold & Silver Polishing Cream

This 3.3oz tube comes with protective glove and a small brush to reach tight spots. Made in Germany.

470.501	\$16.75
----------------	----------------

Majic Drain saves your rings and gemstones

Easy to clean and retrieve articles which would otherwise be lost forever. The see-thru trap saves all small valuables. Snap-off filter is easily removed for instant recovery of lost article. Majic Drain can be easily installed and fits 1 1/2" or 1 1/4" drain pipes. All plastic, no rust or corrosion. Directions included.

470.222	\$14.25
----------------	----------------



470.222

Let ZAP-TRAP keep your gems out of the drain

The simplest, most effective drain trap available. Stainless steel rim and screen are heavy enough to stay put. The fine mesh catches the smallest of stones or particles. Fits virtually any sink drain from 1 1/8" to 2 1/2" diameter. Recover your investment many times over.

470.228	\$6.50
----------------	---------------



470.228

**Polishing Compounds,
polishing tools & supplies
on pages 30 - 35.**

CONNOISSEURS® Professional Jewelry Care at Home

Concentrate & Silver Cleaner available in gallons



231.01885



231.01868



231.01880



230.003



230.004

230.012



231.01857

Consumer Jewelry Cleaners

Regular formula is the safe, easy way to restore the original luster to diamonds, precious stones, platinum and gold jewelry. Delicate formula restores the original luster to opals, coral, onyx, turquoise, pearl and other delicate stones. Also perfect for fashion jewelry. Includes dipping tray and brush. 8oz jar.

Consumer resale \$4.95

231.01885 **\$3.75 ea 12 @ \$3.35 ea**

Cannot be shipped by air.

Connoisseurs® Delicate Cleaner for Semi-Precious Stones, Pearls, Opals and Costume Jewelry

Delicate Bath is good for cleaning semi-precious stones, such as, pearls, opal, coral, onyx, turquoise and costume jewelry. 8 oz. with dip tray and brush.

231.01868 **\$4.00 ea 12 @ \$3.75 ea**

Cannot be shipped by air.

Silver Jewelry Cleaner

Unique formula quickly removes dirt and tarnish and restores the original luster to silver jewelry. Consumer resale \$4.95

231.01880 7oz jar **\$3.75 ea 12 @ \$3.35 ea**

231.01881 One Gallon **\$28.75**

Cannot be shipped by air.

Connoisseurs® Precious Cleaner for Platinum, Gold, Diamonds and Precious Stones

Polymers in its formula help reduce the appearance of tiny scratches built up in settings over time. Precious Jewelry Cleaner is a good way to clean most metals used in making jewelry today. 8 oz. with dip tray and brush.

230.003 **\$4.00 ea 12 @ \$3.60 ea**

Connoisseurs® Silver Bath for Sterling Silver Jewelry

Sterling silver dip offers a fast, easy way to remove tarnish and add shine and brilliance back to sterling silver jewelry. Use only on sterling silver. 8 oz. with dip tray and brush.

230.004 **\$4.00 ea 12 @ \$3.60 ea**

Connoisseurs® Diamond Dazzle Stick

Sized to fit in a makeup case or purse for home or travel. Twist-to-dispense click pen delivers solution to the unique brush engineered for ease of cleaning behind diamonds and other precious stones and mountings. High performance micro-fine cleansers and polishing agents are combined with a polymer.

230.012 **\$5.95 ea 6 @ \$5.25 ea**

Connoisseurs™ Jewelry Cleaner Concentrates

Specifically developed for sonic applications. Regular Formula for gold, diamonds and precious stones and stubborn soil. Delicate Formula for pearls, semi-precious stones, light soil. 8 oz bottle makes 1/2 gallon of solution. Consumer resale \$6.45.

231.01857 8 oz Regular Formula **\$6.10**

231.01910* One Gallon Regular Formula **\$28.95**

231.01856 8 oz Delicate Formula **\$5.75**

231.01882* One Gallon Delicate Formula **\$26.95**

Cannot be shipped by air.

Selvvt Polishing Cloths

Soft velvety Selvvt makes it ideal for polishing jewelry and timepieces. Precision optics and silverware both benefit from the lint free surface. Crystal and glasses sparkle with Selvvt's unique polishing property. Selvvt retains its softness and durability even after many washings.

170.080	5"	\$1.95 ea	3@ \$1.75 ea	12 @ \$1.50 ea
170.081	10"	\$7.50 ea	3@ \$6.75 ea	12 @ \$6.50 ea
170.082	14"	\$7.75 ea	3@ \$7.25 ea	12 @ \$6.85 ea



170.080 - 170.082

Rouge Cloth

A double cloth, one impregnated with rouge and an outer cloth which keeps your hands clean and is used for final finish. 11" x 9".

170.076	\$5.25 ea	12 @ \$4.75 ea
----------------	------------------	-----------------------



170.076

Shino Cloth

Double cloth, one impregnated with jeweler's rouge and the an outer cloth for final finish. In plastic pouch. 12" x 14".

170.090	\$4.75 ea	12 @ \$3.75 ea
----------------	------------------	-----------------------



170.090

Cloth with Compound

Impregnated with polishing compound, ideal for cleaning and polishing precious metal, fine crystal and glass. France. 12" x 8"

170.699	\$3.75 ea	12 @ \$3.25 ea
----------------	------------------	-----------------------



170.699

Connoisseurs Ultra-Soft Polishing Cloth

A rougeless, dual-cloth buffing system. Ultra-soft for Jewelry cleans and buffs gold and silver jewelry. Ultra-soft for Silver lifts tarnish from sterling silver, silver plate, flatware and hollowware, while leaving a protective, anti-tarnish coating. Measures 11" x 14".

171.0270	Cloth for Jewelry	\$4.95
171.0271	Cloth for Silver	\$5.20



171.0270
171.0271

Connoisseurs® Quick Jewelry Cleanser

This quick beauty treatment for diamonds, gemstones, gold and platinum. This gentle cleansing gel lets you quickly and safely clean jewelry. Quick Jewelry Cleanser's special jewelry cleaning brush snaps on the jar for convenient storage. Gentle on hands. Not for use on pearls. 5 fl. oz.

230.014	\$3.75
----------------	---------------



230.014

Connoisseurs® Disposable Jewelry Wipes™

Safely cleans and polishes gold, silver, gemstones and costume jewelry anytime, anywhere. Leaves an anti-tarnish shield on silver jewelry to maintain a like-new luster. Dry. Disposable. Non-toxic. Unscented and disposable. 25 wipes 3"x3¾" in compact dispenser.

231.01850	\$4.95 ea	12 @ \$4.00 ea
------------------	------------------	-----------------------



231.01850



170.102
170.103



170.504



170.106



170.093

Cape Cod® Touch-Up Gloves

Made of 100% cotton for removing fingerprints and light tarnish between polishings. Ideal for handling silver place settings.

170.504 **\$7.25**

Cape Cod® Metal Polishing Cloths

Contains Two 4" x 6" soft moist metal polishing cloths that clean, polish, and protect all fine metals. In a resealable foil pouch. Anti-tarnish formula for a long lasting shine.

170.106 **\$6.25**



170.620



171.075

Cotton Gloves protect jewelry and silverware

Protect valuables from fingerprints, spotting and tarnishing. One size fits most hands. White cotton.

170.102 Heavy weight **\$9.95 dz**

170.103 Light weight (slightly smaller than heavy) **\$6.50 dz**

"MoonGlow" Microfiber Polishing Cloth

Super soft sueded microfiber cloth feels and polishes jewelry like chamois. Great for cleaning eyeglasses too. 8" Square.

170.093 **\$4.50 ea 12 @ \$4.00 ea**

Micro Fiber - Especially for Diamonds

Lintless cloth will not snag or shed. Optimum texture and softness for cleaning film from precious stones, especially diamonds. 12" x 12"

170.620 **\$5.50 ea 12 @ \$4.80 each**

Soft Blue Lintless Cloth won't snag or shred

Made from an untreated fiber that will not snag or shred. Perfect for cleaning precious stones and diamonds. 9" x 10".

171.075 **\$2.80**



170.105

Sunshine Polishing Cloth

Safely cleans jewelry, metals and almost any surface. Soft and felt-like, this amazing cloth is embedded with special no-scratch micro-abrasive and chemical cleaning agent which works for double cleaning and polishing action on gold, silver, brass, copper, mirrors and glass. Measures 7 7/8" x 5". Made in Japan.

170.105 **\$3.25 ea 12 @ \$2.75 ea**

Polishing compounds, polishing tools and supplies on pages 32-35.

Floor Model Dust Collectors

ARBE Dust Collector Delivers 1000 CFM Suction Power

This floor model polishing system from ARBE, the industry's leading manufacturer of polishing equipment, features:

- Heavy wall sealed cabinet which insures maximum collection efficiency with minimum noise and no vibration.
- Stack on silencers is standard with all ARBE floor models.
- Equipped with two access doors, four suction ports.
- Wide fishmouth hoods to thoroughly capture all flying debris.
- 24 ultra weave cotton sateen filter bags.
- Pro Series 1/2 HP Double Spindle Polishing Motor. 3450 RPM.
- 1000 CFM 1 HP Dust Collector.
- Formica working surface measures 48" x 28".
- Unit is 56" High overall, 41" to working surface.
- Weight 400 lbs. Made in USA.

470.091*

\$2925.00



Made in USA



Made in USA



Grobet USA™ Deluxe Floor Model Dust Collector

Popular for dental labs as well as jewelers, this Deluxe Floor Model Dust Collector offers you a quiet dust-free polishing environment, with the addition of two plexiglass enclosures surrounding the polishing area. The hands and work are placed inside the enclosures, while the 600 cfm, 1/4 HP suction motor collects compounds and debris. The 4" thick pleated filter provides a large surface area making it an excellent collecting system for polishing compounds and metal sweeps. Two flexible-neck lamps are affixed to the cabinet for concentrated lighting. Heavy gauge metal cabinet is supplied with a Baldor polishing motor and tapered spindles and is suitable for wet or dry polishing.

- 2-Speed Baldor (1725/3450 RPM) Double Spindle, Sealed Polishing Motor.
- Extremely quiet operation.
- Overall Height (excluding lamps) 53".
- Floor to bench top height 40".
- Width of unit 44". Depth of unit 18".
- Shipping Weight 272 lbs.
- Made in USA by Grobet USA™.

471.087*

\$3146.20

Grobet USA™ Replacement Pleated Filter

Used in Grobet dust collectors 471.087 and 471.085, this filter measures only 12" x 24" x 4" yet, because of its pleated construction, you get nearly five times the surface collection area than you would in a regular flat filter of the same size.

471.190

\$14.90

* These floor model polishing units are made to order and shipped directly from the manufacturer. Please allow 3 weeks for delivery. F.O.B. Cincinnati, OH



470.090*

Handler Standard 500 CFM Polisher & Dust Collector

This superior unit is made of heavy gauge sheet metal and contains two high pumice (polishing) hoods mounted on either side of the Red Wing polishing motor. Both sides can be operated simultaneously, wet or dry. Air intake is channeled through two supplied fiberglass filters. Not for grooving models.

- Suction Motor - 1/4 HP, 3450 RPM, 115 Volts/60Hz.
- Polishing Motor No.26, 2 Speed, 1725/3450 RPM, tapered shafts.
- Suction Capacity - 500 CFM.
- Filter Area - Two 12" x 25" x 2" fiberglass, 1200 cubic inches.
- Accessories - Two 14" H x 13" D x 7 1/2" wide aluminum shielded hoods with lights and insert pans. Overhead shelf.
- Dimensions - 56" H x 32" W x 18" D - 38" to bench top.
- Hood 13 1/2" H x 10 3/4" D x 7 1/4" W.
- Weight 185 lbs.

470.090*	\$1949.00
470.180 Replacement Filter	\$7.75

HANDLER
MANUFACTURING COMPANY, INC.



470.061

Filter Barrier for Handler Model 65M

Filter barrier pack of 3 for Handler 65M Dust Collector.

470.101	\$10.95/3 pack
---------	-----------------------

Filter for Handler Model 90AA

Filter pack of 3 for Handler 90AA Dust Collector. 12" x 32" x 2".

470.102	\$72.00/3 pack
---------	-----------------------

ZANTECH
INC.



590.801

Super Sucker II will improve your work environment

Super Sucker clears the air of dust and fumes generated by grinding and polishing tasks . . . at your bench. This unit has been a favorite for years in the dental trade for use as an under bench, single station dust collector. Depending on the job, you may place the fishmouth inlet at benchtop level on a bench pin, or place it in the bench's lap tray. It's flexible, easy to use and stores away next to the bench when not in use.

- Collects all 1 micron and larger dust particles, keeping them away from your face.
- Dual filter system; a removable filter bag and an activated charcoal filter.
- Variable speed control draws varying amounts of waste.
- Compact cabinet 10" x 15 1/4" x 14". Includes 6' flexible hose.
- Durable, lightweight and quiet. 115 volt.

470.061 Super Sucker II	\$475.00
470.061.1 Filters, pack of 6	\$45.00

Professional Vacuum Cleaning System for the Watchmaker and Electronic Technician

The Zantech vacuum system combines a quiet and compact compressor with precisely tuned vacuum. Button operated stylus and handy foot switch give you a safe and efficient way to remove dust and debris from delicate electronic circuit boards and components. Perfect for black dials. Kit includes Quiet Vacuum Pump, Foot Switch, Fingertip Control Stylus with soft white vacuum brush, and Flexible Hose with in-line filter and hanger.

590.801*	\$1295.00
----------	------------------

**Looking for something less intense?
Find handheld dust blowers on page 262.**

* Special Order. Handler polishing units are made to order and shipped directly from the manufacturer. Please allow 3 weeks for delivery.

Deluxe Professional Polisher and Dust Collector

This extremely well-built unit features:

- Heavy gauge steel construction with heavy baked enamel finish.
- Sealed and insulated cabinet for maximum efficiency.
- Easy two-latch hinged cover for easy filter replacement.

Flanged top holds extra wheels.

- Lighted hood.
 - Squirrel cage blower provides the strongest suction in its class.
- Air intakes are precision engineered.

- Preassembled motor with welded motor mount.
- 1/2HP/3450 RPM sealed polishing motor offers quiet operation.

- 1/2" straight shaft with double tapered spindles.
- Measures 30"W x 22"D x 12"H. 70lbs. F.O.B. Cincinnati Ohio.

470.035 ARBE Polisher/Dust Collector **\$519.95**

470.192 Filter for ARBE Dust Collector 11 1/2" x 30" x 2" **\$10.50**

470.098 Filter for ARBE MD-205 22" x 12" x 2" **\$10.50**



470.035

ARBE

Made in USA

Handler Compact Bench Top Polisher and Dust Collector

This unit has a 1/3HP, 3450RPM polishing motor with 1/2" double shafts, and left and right 5/8" tapered spindles supplied.

- Dual axial suction motor, 115volt/60Hz with thermal overload protection. 465 CFM suction capacity.
- Two 8" x 4" front intake suction openings.
- Double work light.
- Removable filter for shake out or vacuuming.
- Filter area 12" x 20" x 2". Unit is 20 1/2"W x 19 3/4"D x 12 1/2"H.
- Shipping weight 70 lbs.

470.062 **\$399.50**



470.062

HANDLER
MANUFACTURING COMPANY, INC.

Double Spindle Polisher/Dust Collector

Compact unit with 110 volt, 6.6 Amp polishing motor produces 1/3 HP and 3450 RPM. With 1/2" tapered spindles, squirrel cage suction motor, double work light and on/off switch.

Unit measures 20 1/4"W x 19 1/2"D x 12"H.

Replacement filter measures 20"W x 12"H x 2"D.

471.2025* Dust Collector w/1/3HP Motor 45 lbs. **\$544.95**

471.2020* Dust Collector only 20 lbs. **\$487.50**

471.053* 1/3HP Polishing Motor only 26 lbs. **\$344.60**

471.277 1/2" Left Tapered Spindle **\$20.30**

471.276 1/2" Right Tapered Spindle **\$20.30**

470.179 Replacement Filter **\$7.75**



471.2025

GROBET USA™ Deluxe Dust Collectors

- Squirrel-cage suction unit provides strong air current (460 CFM).
- Unique rear off-set design allows for air escapement.
- Filter is placed ahead of blowers, protects them from dust.
- On/off switch for motor and lights.
- Dual lights placed to highlight work.
- Convenience outlet for polishing motor.
- Mounted on rubber feet to reduce noise and prevent slipping.
- Can hold accessories up to 6" in diam.
- Overall: 33 1/2"W x 11"H x 22"D. 50 lbs.
- ETL listed. Made in USA.

471.031 110 Volt Model **\$695.00**

471.031X* 220 Volt Model **\$695.00**

470.177 Filter 10" x 32" x 2" **\$10.75**

471.03101* On/Off Switch **\$4.50**



471.031

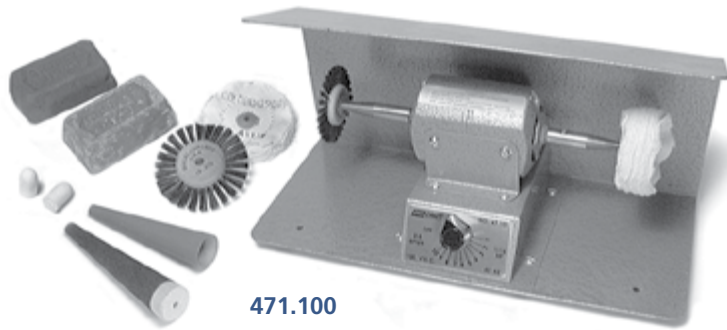

471.100

Junior Polishing Set

Designed to meet the needs of the individual craftsman. Adjustable motor speed for use with various grinding, polishing, and buffing wheels. Hood catches polishing debris. Features: 1/15 HP, 5000 RPM motor, electronic variable-speed control, 120 volt AC, attractive hammertone finish, mounted on rubber feet to prevent creeping, unit has four holes for mounting. Measures 14"W x 6"D x 7"H. Shipping weight 8 lbs. Includes 2½" diameter muslin buff for tripoli, 2½" cotton flannel buff for rouge, tripoli and red rouge, two bristle wheel brushes, two felt cones, two emery ring shells and wood mandrel for ring shells, two ¼" tapered spindles.

471.100

\$259.00



470.115

Benchtop Polisher

Small polisher has pre-lubricated ball bearings & a dust-proof motor housing - it's virtually maintenance-free. You will not sacrifice quality or speed with this well balanced precision polisher.

- Works with standard wheels and buffs up to 4".
- Includes 2 tapered spindles, 2 medium abrasive wheels, 2 replacement motor brushes and screws for bench mounting.
- Variable speed from 1,800 - 7,500 RPM. 110 Volt, 1/6HP motor.

470.115

\$92.50



470.065

470.162

470.163

Variable Speed Motor delivers the smooth power you need for finishing high-end watch cases

Ray Foster 1/3HP PR90 polishing motor is dynamically balanced for smooth, quiet operation and ruggedly built for years of reliable service. Industrial grade, sealed ball bearings never need lubrication. Quick-change chuck is easily mounted on right side. Standard taper shafts with chuck removers. Base may be bench mounted. Spindles sold separately - see below.

- Operates between 300 and 4,000 RPM Speed Range.
- Overall length (spindle tip to spindle tip) 13¾".
- Base dimensions 6¾" X 7½" deep. Height to shaft center 5¼".
- 1/3 HP, 115 volt 60 hz. • Shipping weight 31 lbs.

470.065

\$679.00

Chucks (Spindles) for the Ray Foster Motor

Spiral and Stone Chucks for use with polishing buffs on the Ray Foster motor. Stone Chucks for 1/4" to 3/8" thick wheels.

470.162 Spiral Chuck Left Side P91L **\$13.50**

470.163 Spiral Chuck Right Side P91R **\$13.50**

470.164 Stone Chuck Right Side P94R 1/4" Arbor **\$17.75**

470.165 Stone Chuck Left Side P94LR 1/4" Arbor **\$17.75**



See page 277 for our
FUME EXTRACTOR
Item # 470.005

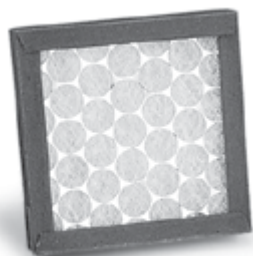

Ionbox

This portable USB/AC is an easy and compact way to rid your workspace of dust, smoke, allergens, odors, and silica. No filter to change!

470.516

\$49.95

Replacement Filters for Dust Collectors

No.	Dimensions	Price	No.	Dimensions	Price
470.171	10 x 10 x 2"	\$7.95	470.180	12 x 25 x 2"	\$7.75
470.172	10 x 10 x 1"	\$3.25	470.182	12 x 32 x 2"	\$10.50
470.173	10 x 20 x 1"	\$3.50	470.184	9¾ x 12¾ x 1"	\$4.50
470.175	12 x 25 x 1"	\$4.25	470.187	9¾ x 32 x 2"	\$9.95
470.176	9¾ x 12¾ x 2"	\$8.50	470.188	10 x 20 x 2"	\$4.75
470.177	10 x 32 x 2"	\$10.75	470.189	9¾ x 32 x 1"	\$6.95
470.178	10¼ x 23¼ x 1"	\$6.75	470.190	10 x 32 x 1"	\$8.25
470.179	12 x 20 x 2"	\$7.75	470.191	12 x 30 x 2"	\$7.75

Tapered Chuck for Brushes

Brushes with 1/8" holes can be threaded onto the hardened steel taper which in turn can be threaded onto a standard tapered spindle. Handy for small setting brushes on polishing motors.

471.258 Right	\$5.10
471.259 Left	\$5.10

Heavy-Duty Wood Hub Mandrel

For right side. 1/16" diameter screw.

471.260	\$3.50
----------------	---------------

Tapered Spindles for Straight Shaft

Designed to fit any straight shaft motor. Made with either right or left-handed threads (for right or left side of motor) and held to shaft by set screws. Threads are clear, deep, and end is pointed. Made in USA

Shaft	Right	Left	Price
1/4"	471.270	471.271	\$16.50
5/16"	471.272	471.273*	\$17.90
3/8"	471.274	471.275	\$18.20
1/2"	471.276	471.277	\$20.30
5/8"	471.278	471.279	\$20.80

Tapered Spindles for Tapered Shaft Motors

Made in USA.

No.	Side	Metal	Price
471.234*	Right (Baldor)	Brass	\$49.95
471.235*	Left (Baldor)	Brass	\$49.15
471.236	Right	Brass	\$18.95
471.237	Left	Brass	\$18.95
471.238	Right	Steel	\$21.00
471.239	Left	Steel	\$21.00

Wheel Arbor

Designed to hold grinding wheel on right side of motors with 1/2" straight shaft. For wheels with 1/2" hole.

471.256	\$22.65
----------------	----------------

Chuck Accessories with 1/4" Shank

No.	Type	Side	Metal	Price
471.224	Taper	Right	Steel	\$7.65
471.226*	Stone*	Right	Steel	\$7.65
471.230*	Band	Right	Brass	\$7.75

*For wheels up to 2 1/2" diameter, 1/4" thick, with 1/4" arbor hole.

Brass Stone Chucks for Motors

Taper is 1/4" per foot. For use with wheels up to 3" diameter and 1/4" thick, with 1/4" arbor holes.

471.200 Right	\$11.95
471.201 Left	\$12.60

Bur Chuck for Tapered Shaft Motors

5/32" capacity for right shaft. Brass body with steel knurl.

471.205*	\$33.60
-----------------	----------------

Bur Chuck for for Tapered Shaft Motors

1/4" capacity with short shank. Steel for right shaft.

471.203	\$25.55
----------------	----------------

3M Tapered Spindle Adapter

Plastic adapter lets you use wheels with 1" arbor holes on tapered spindles. Works with 6" grinding and finishing wheels only.

110.980	\$14.75
----------------	----------------

471.258
471.259



471.260



471.270



471.234 -
471.239



471.256



471.224



471.226



471.230



471.200
471.201



471.205



471.203



110.980





470.990

Best Built Magnetic Tumbler

Best Built Magnetic Tumbler has a 3-1/2" diameter bowl for 1 to 6 rings. Quickly and efficiently polish small jewelry with this dependable machine. This professional quality magnetic tumbler from Best Built polishes metals - even inside rings, undercuts, channels, fine filigree and other hard to reach places - much faster and better than you could polish by hand. Powerful DC motors with direct drive get your work done in 30 minutes for gold, 45 minutes for platinum. 60 minute timer, auto shut off. One year warranty on tumbler; 30 day warranty on bowl.

470.990

\$259.00



470.999

Cas-Ker Mini Magnetic Finisher

Heavy duty unit is dependable, quiet and time saving. Completely eliminates bombing and stripping. Powerful magnetic disc spins tiny steel pins around the jewelry pieces, leaving a bright finish. Both centrifugal and elliptical motion throughout the entire bowl eliminate the use of specially formed bowls. Ideal for filigree and other fine pieces. You'll see results never possible with conventional tumblers.

- Compact - holds 30 rings.
- Bowl dimensions: 5" diameter x 4" high.
- Unit dimensions: 7.25" wide x 8.5" deep x 10" high.
- Insulated fan-cooled variable speed motor to 3450 RPM.
- 60 minute timer.
- One year warranty.

Shipping weight 20lbs. F.O.B. Cincinnati, Ohio

470.999

\$899.00

Steel Pins for Mini Finisher

470.998 0.50mm x 5mm. 8 oz.

\$54.95



470.998

470.104



470.997

Burnishing Compound

Mildly acidic for high speed burnishing, tumbling and applications using magnetic needles. Special lubricating additives produce a lustrous finish to copper, aluminum, zinc, nickel silver and their alloys. Inhibits rust on steel shot. Cannot be shipped by air.

470.997 One Gallon \$33.60



Jeweler's Mix Stainless Steel Tumble Shot

Stainless steel media for tumbling. Combination 3/16" balls, 1/2" pins & 3/16" diagonals for coverage on a wide variety of pieces.

470.104 2 lbs.

\$51.50

Stainless Steel and Carbon Tumbling Shot

A fast form of tumbling used to burnish metal to a mirror bright finish. Uniform in size and shape, non-abrasive and carefully tempered to ensure long life. Stainless steel is rust and corrosion-resistant, making it ideal for use in wet, flow-through systems. Balls, Ball Cones, and Mixed Shot available. **CALL FOR DETAILS.**

Vigor® Natural Tumbling Media

Untreated corn cob, charged walnut shell, and shot cleaner & restorer available. **CALL FOR DETAILS.**

GROBET Rotary Tumblers

Outstanding polishing and smoothing. These units offer ease of use, excellent durability and quiet, water-tight operation.

VIGOR® Vibratory Tumblers

This economical mass finishing technique gives you a more uniform finish on large quantities of parts in much less time than standard hand finishing, without the mess. Holds the overall shape of the pieces better and allows you to check the progress of the work without stopping the unit. Compact, durable tumblers are donut shaped for uniform polishing and maximum coverage. Heavy polyethylene lids and bowls remove easily for emptying and cleaning. Units have two valves and a strainer for optional flow-through operation (except No.471.785). Quiet ball-bearing motors have thermal overload protection and 3000 RPM at 60/Hz. One year warranty. USA. To determine the right size tumbler for your needs, each cubic foot of capacity will hold approximately 500 ladies rings. Nos.471.786 and 471.785 will hold 50. No.471.787 will hold 100 rings. No.471.788 will hold 300 rings.



471.785



471.780

Tumblers No.	Capacity Working	Capacity Cu.Ft.	Max Load lbs	Bowl Diam.	Bowl Hght.	Volt	Price
471.785*	3 qt	0.1	10 lbs	10"	4"	110	\$331.30
471.786*	3 qt	0.1	10 lbs	10"	4"	110	\$431.50
471.786X*	3 qt	0.1	10 lbs	10"	4"	220	\$477.30
471.787*	6 qt	0.2	18 lbs	11 ¹ / ₂ "	12"	110	\$618.65
471.787X*	6 qt	0.2	18 lbs	11 ¹ / ₂ "	12"	220	\$575.00
471.788*	4 ³ / ₄ gal	0.6	57 lbs	17"	7"	110	\$1040.00
471.788X*	4 ³ / ₄ gal	0.6	57 lbs	17"	7"	220	\$1040.00

Replacement Bowls

No.	Capacity	Ship.Weight	Price
471.78501*	3 quart	3 lbs	\$82.00
471.78601*	3 quart	3 lbs	\$109.95
471.78701*	6 quart	5 lbs	\$139.00
471.78801*	4 ³ / ₄ gallon	7 lbs	\$295.00

*Note: 471.785 and 471.78501 are for dry polishing only; cannot be used with flow-through system.

Heavy-Duty Tumbler

Professional quality tumbler features a larger, more powerful, continuous-duty, fan-cooled motor with overload protection. Steel hexagon barrel, with removable liner ensures long, efficient and quiet operation. 15 lbs. capacity, with a five year warranty on the barrel and liner. Shipping weight 18 lbs.

471.780*	Tumbler 110 volt	\$324.95
471.780X*	Tumbler 220 volt	\$408.45
471.783*	Replacement Barrel Ship. Weight 8 lbs.	\$159.95



471.782

Two Barrel Tumbler

Versatile, two barrel 6 lbs. capacity tumbler uses two 3 lbs. long-life, molded rubber barrels, ideal for small batches of single type stones for jewelry making or brass polishing. Continuous-duty, fan-cooled motor with overload protection.

471.782	Tumbler 110 volt	\$219.75
471.782X*	Tumbler 220 volt	\$297.05
471.784*	Replacement Barrel	\$39.40
471.78002*	Drive Shaft Belt	\$6.85

One Barrel Tumbler

3 lb. capacity with heavy gauge steel base, water-tight, molded rubber barrel and thermally protected motor.

471.781*	Tumbler 110 volt	\$195.65
471.781X*	Tumbler 220 volt	\$260.60
471.784*	Replacement Barrel	\$39.40
471.78002*	Drive Shaft Belt	\$6.85



471.781



470.000

Tumbler for Gemstones

Lortone Lapidary Tumbler is a quiet, durable grinding and polishing machine. This rotary tumbler will help you produce sparkling, natural gemstones of professional beauty and polish. Features a 3 lb. capacity molded rubber barrel with quick-seal closure and a continuous-duty fan-cooled motor.

470.000	\$92.90
---------	---------

Drive Belt for Tumblers

471.78002	\$6.85
-----------	--------



Merard EXTREM Polishing Compounds

A customer favorite! Merard's EXTREM line of solid polishing compounds are specifically designed for complex polishing configurations. Great for ceramic, metals, and more!
30 grams each.

- S10 is used in preparation
- S20 is used for finishing
- S30 is used for super-finishing of ceramic, platinum, and high-hardness metals and hardening steels.

470.520	S10	\$24.95
470.521	S20	\$24.95
470.522	S30	\$24.95

Blue Magic Compound

For final finish on Platinum. Leaves a bright, scratch free, mirror finish. Excellent for all other metals as well. 1/4 lb.

470.497		\$8.75
---------	--	--------

Platinum Polish Compound

A fine quality green compound highly recommended for polishing and final brightening which produces a brilliant sparkle on platinum and various steel. 2 lb tube.

470.514		\$43.95
---------	--	---------

Brite White for Platinum

Makes polishing effortless compared to existing compounds and gives a brighter shine. Easy cleanup, dry, leaves little residue, washes out better than rouge. Thoroughly jeweler tested. 1/4 lb.

470.301		\$6.50
---------	--	--------

Polinoxx for Stainless Steel and Titanium

Super finishing! Final polishing compound developed for an impeccable finish on stainless steel, nickel and titanium. Swiss made. 4" white 1/4 lb bar.

470.513		\$13.75
---------	--	---------

Polinum for Final Platinum and Gold Polish

Superior compound for the final polishing of platinum, white gold, yellow gold, pink gold and high quality stainless steel. 4" orange 1/4 lb bar.

470.302		\$16.75
---------	--	---------

Polishing Compound for Platinum, Gold & Stainless

A selected grade of polishing compound formulated for ultra-bright finishing of platinum. Exceptional adherence to buffs, brushes or felts. Two grades: Grey Tripoli (470.298) for initial smoothing of roughness, and Picasso Blue (470.299) for ultra-bright finish on platinum and gold, plus it works great on stainless steel. Blue polish is cleaner and less messy to use than red rouge and it leaves very little residue.

470.298	Grey 800 grit 1 lb.	\$29.50
470.299	Picasso Blue 1/4 lb.	\$26.25





471.320 - 471.329



470.506 - 470.512



470.461 - 470.496

Pro-Craft® Rouge and Tripoli in Peel-Back Tubes

Eliminates the mess and does away with broken bars. Peel-back cardboard tube exposes only the amount needed.

Black rouge for producing a rich, dark luster on white gold, platinum, or silver.

471.320 Black \$4.50

Green rouge imparts a high luster on hard metals; chrome, stainless, platinum.

471.321 Green \$5.60

Plastic compound for polishing hard plastics (not to be used on soft or low melting plastics such as polyethylene).

471.322 Plastic \$4.20

Red rouge for the final high color and luster on gold, silver and other soft metals.

471.323 Red \$6.90

Water Soluble Red rouge - Special formula for easy clean up.

471.324 Water Soluble Red \$6.95

Tripoli Fine cutting abrasive for use on all metals where rouge is used for final finish. Leaves metals scratch-free, but dull.

471.325 Tripoli \$3.45

White rouge - a quick polishing compound for hard metals such as stainless steel, chrome or platinum.

471.326 White \$4.00

Yellow rouge for hard metals such as platinum, chrome and stainless steel. Leaves little residue on work.

471.327 Yellow \$5.85

Emery - used on iron, steel and hard metals for coarse buffing and removing scratches, rust, corrosion, burs, etc. Not for gold, silver or plated articles.

471.331 Emery \$3.75

Wonder Bar - Final touch high finish on metals and plastics. Removes scratches. Clean and greaseless with no discoloration.

471.328 Wonder Bar \$3.75

Peel-Back Compound Set

Five most used compounds: red rouge, yellow rouge, brown tripoli, plastic rouge and emery. Peel-back cardboard tubes.

471.330 \$19.50 per set

Dialux Polishing Compounds

For expert results on all metals. 1/4 lb. Bars.

470.506 Blue for super finishing on gold and all metals \$7.25

470.507 Green for Rolex cases, very hard stainless steel, etc. \$7.25

470.508 Red for gold and silver \$6.50

470.509 White gives a shine to all metals \$6.50

470.511 Gray for stainless steel \$6.85

470.512 Yellow for plastic, soft metals, copper, brass \$6.50

Rouge Sticks

First quality rouges for various polishing needs. Available in the following compositions:

Red - No finer composition exists for producing the final, wondrous color and luster on gold and silver.

470.461 Red Rouge 1/4 lb \$3.25

470.462 Red Rouge 1 lb \$7.95

White - Use on platinum, chrome and stainless steel.

470.470 White Rouge 1/4 lb \$3.25

Green for use on white gold, platinum, chrome & stainless steel.

470.467 Green Rouge 1/4 lb \$7.25

Golden Glo for adding high lustre and color to gold.

470.473 Golden Glo 1/4 lb \$3.25

Black gives a rich dark coloring on white gold, silver and platinum. Especially useful on musical instruments.

471.464 Black Rouge 1/4 lb \$4.75

471.465 Black Rouge 21.5 oz \$14.45

Yellow - Very dry, low-residue compound imparts a brilliant finish on gold, platinum and other hard metals.

471.494 Yellow Rouge 1/4 lb \$4.25

471.496 Yellow Rouge 28 oz \$11.40

471.433 - 471.493



Bobbing, Crocus & Tripoli

For cutting or abrasive action. Leaves metal scratch-free, but dull in appearance.

Bobbing Compound (tan) For brush or lap work.

471.477 Bobbing 1 lb. \$5.30

Crocus - Popular for split lap use, platinum and hard metals.

471.433 Crocus 1 lb. \$7.75

Brown Tripoli - Standard fast-cutting tripoli use when rouge will be used for final finish.

471.479 Brown Tripoli 4 oz. \$3.95

471.480 Brown Tripoli 1 lb. \$5.25

Gray Tripoli - Popular for split lap use, platinum & hard metals.

471.484 Gray/Platinum Tripoli 2lbs. \$12.10

471.493 Gray Steel 2.5 lbs. \$15.00

White Diamond Tripoli XXXX - A finer abrasive, leaves some degree of finish. Excellent for gold, silver, platinum.

471.489 White Diamond Tripoli 1 lb. \$6.35

Graystar polishing compound for cutting, smoothing rough edges and removing scratches.

471.493 Graystar 1 lb. \$15.00



471.312
471.313



471.502
471.503



470.370



470.518



170.075

470.500



SILVEX® Gold and Silver Repair Polish

SILVEX 4-in-1 polish concentrate cleans, polishes, seals and removes minor scratches from gold and silver jewelry. Includes 25g/0.88oz. concentrate, a polishing cloth and microfiber cloth.

470.500 **\$13.25**

FLITZ Metal Polish

Cleans and protects up to 6 months. Acid-free, non-toxic, non-abrasive paste for gold, silver, brass, platinum, chrome, copper and marble. Safe for heavy plated work. 50 gram tube.

471.457 **\$18.45**

Polish-It Jewelry Holder

Simply hold jewelry piece in the Polish-It cradle while rotating the tool against the buff wheel on your polishing machine. Curved design supports chains, bracelets, pendants, and watchbands. Solid wood won't conduct heat, avoiding burnt fingers. Gives greater control for a perfect job.

170.317 **\$11.95**

FABULUSTRE®

Provides a high-luster finish on all types of precious and decorative metals. Removes light scratches and produces a fast, mirror-bright, final finish without discoloration. Grease-less, dry but not dusty. Fast and easy cleanup with little or no residue.

471.312 1/4 lb. tube **\$5.55**

471.313 1 lb. tube **\$9.20**

ZAM® Buffing Compound

Formulated for silver and turquoise. Will not scratch soft stones and stones do not have to be removed for buffing. Leaves a high luster without residue. Fast clean-up, does not penetrate stones. Versatile, many goldsmiths prefer ZAM to rouge as a final finish.

471.502 1/4 lb. tube **\$5.60**

471.503 1 lb. tube **\$10.50**

Greystar Compound

Dry compound designed especially for the jewelry trade for fast cutting, removing scratches and smoothing rough edges before final finishing. Generally used with felt wheel buffs. 1/4lbs Bulk.

470.370 **\$5.25**

Grisinox Compound

Ideal for use on steel, chrome, brass, nickel, dirty bronze, platinum, German silver, marble, titanium and granite. 3/4 lb.

470.518 **\$21.95**

Simichrome Polish

A soft, paste polish for chrome, silver, aluminum, brass... virtually any metal. Cleans to a brilliant shine and leaves protective film. Germany. 1.76 oz. Sold by the carton of 24 or individually.

170.075 **\$9.50 ea 24 @ \$8.50 ea**

SILVEX® Gold and Silver Repair Polish

SILVEX 4-in-1 polish concentrate cleans, polishes, seals and removes minor scratches from gold and silver jewelry. Includes 25g/0.88oz. concentrate, a polishing cloth and microfiber cloth.

470.500 **\$13.25**

FLITZ Metal Polish

Cleans and protects up to 6 months. Acid-free, non-toxic, non-abrasive paste for gold, silver, brass, platinum, chrome, copper and marble. Safe for heavy plated work. 50 gram tube.

471.457 **\$18.45**

Polish-It Jewelry Holder

Simply hold jewelry piece in the Polish-It cradle while rotating the tool against the buff wheel on your polishing machine. Curved design supports chains, bracelets, pendants, and watchbands. Solid wood won't conduct heat, avoiding burnt fingers. Gives greater control for a perfect job.

170.317 **\$11.95**

Polishing/Buffering Kit for Small Motors

Just right for 1/15 HP motors with variable speeds. Kit contains 2 1/2" diameter muslin buff for tripoli, 2 1/2" cotton flannel buff for rouge, 2 1/2" bristle wheel for tripoli, 2 1/2" bristle wheel for rouge, 1/4lb. tripoli, 1/8lb. red rouge, wood mandrel with 2 emery ring shells and two felt bobs.

471.026 **\$22.60**



471.026

Polishing/Buffering Kit for Large Motors

Larger buffs and brushes for 1/6 to 1/2 HP motors with 3450 RPM. 4" diameter muslin buff for tripoli, 4" cotton flannel buff for rouge, 2 1/2" bristle wheel for tripoli, 2 1/2" bristle wheel for rouge, two felt crevice buffs, 2 felt ring buffs, wood mandrel with six emery ring shells, 1/8lb. bar of red rouge and 1/4lb. bar of tripoli.

471.027 **\$39.95**



471.027

Powdered Compositions

For use with hand buffs, brushes, felts and wood laps. Mix with water or fine oil to form a paste that will impart a high luster.

- Red Rouge for platinum, gold and silver.
- Tin Oxide for lens polishing and other glassware, fine steel.
- Linde A for precious gems, gold, silver, other metals.
- Ruby Powder gives a high luster to platinum, gold, steel, precious stones, pearl, ivory, horn shell and porcelain.
- Pumice Powder for scrubbing, cleaning or polishing.

No.	Type	Shipping Weight	Price
471.510	Red Rouge	1 lb.	\$13.75
471.516*	Tin Oxide	1 lb.	\$59.95
471.520*	Linde A	1 oz.	\$21.50
471.524*	Ruby	1 oz.	\$7.90
471.525*	Ruby	1/2 lb.	\$46.20
231.400*	Pumice-Flour-200	1 lb.	\$17.50
231.401*	Pumice-Fine-150	1 lb.	\$17.40
231.402*	Pumice-Med-80	1 lb.	\$22.90



471.510

470.372

Genuine BERGEON Polishing Powder

This high quality Extra-Fine Diamontine powder produces a final high lustre on parts and tools. 15 gram bottle.

470.372 **\$8.50**

Luxor Compound Kit covers all your polishing tasks

Assortment of the finest quality polishing compounds for all finishing and polishing. Covers the requirements of a jeweler from A-Z. The kit contains eight different compounds, listed below. Luxor compounds reduce consumption, reduce pollution and result in a final product clean and hardly soiled. All are available separately for reordering.

Individual Luxor Compounds 1/4lb. bars

Number	Color	Grit	For Metals	Price
470.334	Pink	6.5 microns	All	\$9.95
470.335	Green	3.0 microns	All	\$9.25
470.336	Grey	1.0 microns	Platinum	\$9.25
470.337	Blue	1.0 microns	Non-ferrous/Brass	\$9.25
470.338	White	0.3 microns	Platinum/Stainless	\$9.25
470.339	Yellow	0.5 microns	Yellow/Pink Gold	\$9.25
470.340	Orange	0.1 microns	Precious/Platinum	\$10.50
470.341	Dark Red	---	Yellow Gold	\$10.95



470.375

Luxor Compound Kit contains eight different compounds:

Pink	Removes major marks	White	Finishing set pieces
Green	Removes major scratches	Dark Red	Finishing
Grey	Preparatory polishing	Orange	Finishing
Blue	Finishing	Yellow	Super finishing

470.375 Luxor 8pc Polish Kit **\$92.95**

Silicone Softies® Abrasive Wheels Give You a Perfect Finish on Precious Metals

Super soft heatless silicon wheels and points for a smooth and chip-free finish on gold, silver and other metals, plastic and porcelain. These extra high quality abrasives are ideal for finishing fine jewelry. Made in USA.



110.000

Silicone Softies® Assortment

Complete assortment has 60 of the most popular Softies (4 grits, 5 shapes and styles) and 2 mandrels. In a handy plastic box.

110.000 \$36.70

Square Edge	Type	Size	per 20
110.819	White Coarse	7/8" x 1/8"	\$10.50
110.805	Black Medium	7/8" x 1/8"	\$10.50
110.804	Blue Fine	7/8" x 1/8"	\$10.50
110.827	Pink Polish	7/8" x 1/8"	\$10.50
Knife Edge		Size	per 20
110.824	White Coarse	7/8"	\$10.50
110.825	White Coarse	5/8"	\$10.50
110.865	Black Medium	7/8"	\$10.50
110.864	Black Medium	5/8"	\$10.50
110.801	Blue Fine	7/8"	\$10.50
110.800	Blue Fine	5/8"	\$10.50
110.832	Pink Polish	7/8"	\$10.50
110.834	Pink Polish	5/8"	\$10.50
Inside Ring Cylinder		Size	per 12
110.869	White Coarse	13/16" x 7/16"	\$10.50
110.807	Black Medium	13/16" x 7/16"	\$14.25
110.808	Blue Fine	13/16" x 7/16"	\$14.25
110.848	Pink Polish	13/16" x 7/16"	\$14.25
Cylinder		Size	per 20
110.860	White Coarse	13/16" x 1/4"	\$10.50
110.806	Black Medium	13/16" x 1/4"	\$10.50
110.803	Blue Fine	13/16" x 1/4"	\$10.50
110.862	Pink Polish	13/16" x 1/4"	\$10.50
Bullet		Size	per 20
110.861	White Coarse	1" x 1/4"	\$10.50
110.802	Blue Fine	1" x 1/4"	\$10.50
110.863	Pink Polish	1" x 1/4"	\$10.50



Alphaflex Mounted Silicone Polishers

- Brown Alphaflex polishers for pre-polishing gold, precious, semi-precious, non-precious metals. Brings a metal surface to a smooth, low luster finish. 3/32" shanks.
- Green Alphaflex polishers for a mirror finish without using additional polishing materials. Brings a metal surface to an unsurpassed supershine. 3/32".

- 110.040 Brown Point
- 110.140 Green Point
- 110.042 Brown Knife Edge
- 110.142 Green Knife Edge
- 110.043 Brown Straight Wheel
- 110.143 Green Wheel

Swiss Made

\$38.50 dz of one number

SUPER Silicone Wheels

Improved Formula for perfect finish on gold, silver and other metals. 7/8" diameter.

- 110.868 Straight 1/8" Dk Blue Coarse \$7.75 dz
- 110.866 Knife Edge Deep Green Fine \$7.75 dz
- 110.867 Knife Edge Dark Blue Coarse \$10.50/20

Dedeco "Miracle Gold" Silicone Wheels

Silicone carbide - the industry's absolute finest rubberized abrasives for final polishing of gold and semi-precious metals. Eliminates the need for rouge. 7/8" x 1/8" Straight Wheel. USA.

- 110.656 \$24.75 dz

Knife Edge Dedeco Rubberized Abrasives

White Flexies aluminum oxide, soft and flexible for very fine gold polishing. Knife Edge. 7/8" Made in USA.

- 110.180 \$48.25/100

Square Edge Dedeco Rubberized Abrasives

White Flexies aluminum oxide, soft and flexible for ultra-fine polishing of porcelain and gold. Non-contaminating. Square Edge. 7/8" x 1/8"

- 110.148 \$38.50/100



Brightboy Aluminum Oxide Wheels

For deburring, finishing and polishing. The resilient rubber binder cushions the aluminum oxide abrasive and bridges the gap between grinding and polishing. Recommended for use on stainless steel, chrome and precious metals.



101.690 -
101.701



101.672*
101.670
101.687*



101.658



101.650

Brightboy Large Standard Wheels

For use on standard polishing motors.

No.	Diam	Thick	Hole Size	Price
101.690*	1 1/2"	3/16"	1/4"	\$38.50
101.692*	2 1/2"	1/2"	1/4"	\$56.00
101.693*	3"	3/8"	1/4"	\$56.00
101.694*	3"	1/2"	1/4"	\$79.95
101.699*	4"	1/4"	1/2"	\$79.95
101.695*	4"	1/2"	1/2"	\$79.95
101.698*	4"	3/4"	1/2"	\$99.00
101.696*	5"	1/2"	1/2"	\$99.00
101.697*	5"	3/4"	1/2"	\$156.95
101.701	6"	1/2"	1/2"	\$183.50

Brightboy Miniature Wheels

Use miniature wheels with mandrels on flexible shaft machines. 1/16" center holes. Boxes of 100.

No.	Diam.	Thickness	per 100
101.672*	5/8"	1/4"	\$305.70
101.670	5/8"	1/8"	\$256.75
101.678*	7/8"	1/8"	\$219.00
101.684*	1"	1/8"	\$353.50
101.687*	5/8"	Tapered	\$169.00

Brightboy Assortment

57 piece kit contains wheels, cylinders, points, mandrels and chuck. Ideal for those who want a selection on hand to meet the needs of specific production requirements.

101.650 \$148.95

Brightboy Tablet

Ideal for removing scratches and rust, as well as general surface cleaning and finishing. Measures 2 1/4" x 1 1/8" x 3/8".

101.658 \$12.95



111.465

WR Pumice Wheels

For cleaning, polishing and finishing. Made from natural rubber with graded pumice grain distributed to assure uniform results. The light action produces a smooth finish on soft metals. All holes are 1/16".

Pumice 72 Wheel Assortment

Kit includes 12 wheels each of all six styles and 3 mandrels with 1/8" shanks.

111.465 \$85.00

Individual Wheels Boxes of 100.

No.	Style	Shape	Diam	Thick	Price
111.450	822	Square	5/8"	3/32"	\$54.50
111.453	888	Square	7/8"	1/8"	\$87.60
111.458*	908	Taper	3/8"	—	\$99.00
111.459	908	Taper	3/8"	—	\$109.25
111.461	999	Taper	5/8"	—	\$79.95
111.463*	999	Taper	5/8"	—	\$90.90

*White version w/more aggressive action.

More Safety Glasses on page 331.



291.011

Clear Wrap-around Safety Glasses

Durable high quality, polycarbonate lens is highly resistant to impact. One-piece lens provides better visibility without obstruction. Soft comfortable nose pad allows all-day wear. Shadow black plastic frame.

291.011 \$12.95



3M™ Bristle Disks

Bristle brushes up to 1" diameter use with mandrel hole 1/16" or 1/8". Brushes 2" and 3" use with adapter mount 101.3541.

Number	Grit/Mesh	Diam.	Color	Each
101.3501*	80	3/4"	Yellow	\$1.60
101.3502*	220	3/4"	Red	\$1.60
101.3503*	400	3/4"	Blue	\$1.60
101.3504*	Pumice	3/4"	Pink	\$1.60
101.3505*	6 Mic.	3/4"	Peach	\$1.60
101.3506*	1 Mic.	3/4"	Green	\$1.60
101.3507*	120	9/16"	Yellow	\$1.60
101.3508*	220	9/16"	Red	\$1.60
101.3509*	400	9/16"	Blue	\$1.60
101.3510*	Pumice	9/16"	Pink	\$1.50
101.3511*	PolishII	9/16"	Peach	\$1.60
101.3512*	PolishI	9/16"	Green	\$1.60
101.3513*	36	1"	Brown	\$1.90
101.3514*	50	1"	Green	\$1.90
101.3515*	80	1"	Yellow	\$1.90
101.3516*	120	1"	White	\$1.90
101.3517*	80	2"	Yellow	\$3.45
101.3518*	120	2"	White	\$3.45
101.3519*	220	2"	Red	\$3.45
101.3520*	400	2"	Blue	\$3.25
101.3521*	Pumice	2"	Pink	\$3.45
101.3522*	6 Mic.	2"	Peach	\$3.45
101.3523*	1 Mic.	2"	Green	\$3.45
101.3524*	80	3"	Yellow	\$4.80
101.3525*	120	3"	White	\$4.80
101.3526*	220	3"	Red	\$4.80
101.3527*	400	3"	Blue	\$4.80
101.3528*	Pumice	3"	Pink	\$4.80
101.3529*	6 Mic.	3"	Peach	\$4.80
101.3530*	1 Mic.	3"	Green	\$4.50
101.3531*	80	6"	Yellow	\$5.95
101.3532*	120	6"	White	\$5.95
101.3533*	220	6"	Red	\$5.95
101.3534*	400	6"	Blue	\$5.95
101.3536*	6 Mic.	6"	Peach	\$65.75
101.3537*	1 Mic.	6"	Green	\$65.75

Tapered Spindle Mount Adapter

101.3541*	3/8"	\$4.55
-----------	------	--------

3M Radial Bristle Disk Kit

Great bristles for pre-polishing, heavy cleaning, blending, texturing, removing firescale and polishing. Unique flexible abrasive design results in a uniform finish. No compound is needed with these long-lasting disks. Color coded for easy grit selection, disks may be stacked on shank for desired thickness. Open design dissipates heat, unlike rubber wheels. Bonded cubitron mineral abrasive is much harder than most metals. Recommended for handpiece speed between 15,000 and 30,000. Kit includes 60 assorted disks (7 different grits) and two 3/32" shanks.

110.001 \$52.45



3M™ Flexible Diamond Bands

Metal-bonded diamond bands are excellent for shaping and carving on metal or stone. Cuts sanding time in half. Great for quickly removing material on the inside of rings. Use water or Pro-Cut Lubricant with bands to prolong life. 1/2" Diameter x 1/2".

Number	Micron	Grit	Color	Price
101.170	250	60	Green	\$11.50
101.171	125	120	Black	\$12.15
101.172	74	200	Red	\$12.20
101.173	40	400	Yellow	\$10.80
101.174	20	800	White	\$10.80

Mounted Grinding Stones

Green Silicon Carbide - for porcelain and ceramic binders. Cuts fast, lasts long.

Number	Size	Shape
101.120*	1/2" x 1/8"	Square Wheel
101.121*	1/2" x 1/16"	Square Wheel
101.122*	1/2" x 1/32"	Square Wheel
101.123*	1/2" x 1/8"	Umbrella
101.128*	3/16" x 1/8"	Bullet

\$1.10 ea

*SPECIAL ORDER - PLEASE ALLOW 5-7 BUSINESS DAYS FOR DELIVERY.

Blue Aluminum Oxide - Mounted non-contaminating, compressed aluminum oxide for grinding, sharpening and contouring non-precious alloys, chrome-cobalt and nickel. Rough grinding before rubber wheeling.

Number	Size	Shape
101.133*	1/2" x 1/4"	Cylinder
101.136	3/8" x 1/8"	Taper Cone

\$1.30 ea

*SPECIAL ORDER - PLEASE ALLOW 5-7 BUSINESS DAYS FOR DELIVERY.



Abrasive Band Arbors

Rubber heads on 3/32" and 1/8" shanks.

Shank Diameter	For Band Diameter	Price
3/32"	1/4"	\$3.50
1/8"	3/8"	\$3.50
—	1/2"	\$3.50
—	3/4"	\$3.50

CRATEX MX Abrasives

Laminated wheels made of a special blend of cotton, rubber and aluminum oxide grains to produce a wheel that is free cutting, has excellent material removal and extra long life. Excellent for cutting, blending and polishing in one easy step. Wheels can be dressed to a knife edge or used as flat edge wheels. Mounted wheels work well on the inside of rings. #80 grit for sprue removal and deep imperfections. #120 grit for small burs and line removal. #180 and #320 grits are suited for final polishing and blending.

Small Wheels - Maximum RPM: 36,000

Size	Coarse #80	Price	Med #120	Price	Fine #180	Price	Ex-Fine #320	Price
1" x 1/16" x 1/8"	—		101.9812*	\$4.25	101.9813*		\$4.55	—
1" x 1/8" x 1/8"	101.9821*	\$5.65	101.9822	\$7.40	101.9823*	\$5.65	101.9824*	\$5.60

Mounted Wheels - on 1/8" shank.

Safe speed; 3/8" diameter - 17,620 RPM, 1/2" - 12,750 RPM

Size	Med #120	Price
3/8" x 3/4"	101.9862	\$5.75
1/2" x 3/4"	101.9872	\$6.65

Silicon Carbide Wheels

Grinding stones for mild steel, soft metals such as copper, bronze, gold, silver, etc., and some gemstones.

Available in fine (180) and medium (150) grits. The rating on the wheels is not to exceed 8500 RPM.

Fine	Medium	Dia.	Thick.	Hole	Price
111.740	111.741	2"	1/4"	1/4"	\$16.75
111.754	111.755	3"	1/2"	3/8"	\$23.10
111.760*	111.761	3"	1/2"	1/4"	\$22.95
111.763*	111.764	3"	1/2"	1/2"	\$22.95

Emery Mandrels for inside ring sanding

Developed by Kate Wolf for sanding and finishing the inside of rings. Larger diameter barrels work more quickly to do a better job. Set includes three sizes: 1/4", 3/8" and 1/2". Shanks are 3mm on the two smaller ones and 4mm on the larger size. Stainless steel mandrels are machined true and come with rubber bands to hold the emery paper in place. 5/8" long shanks.

Maximum 10,000 RPMs.

430.170 **\$9.95**

Artifex Inside Ring Polisher

Highest quality rubber abrasive lasts up to three times longer than solid felt buffs. 3 1/2" long x 7/8" - 5/8".

130.701 **\$33.50**

GUMMEES® Rubber Abrasives

Extra fine quality silicon carbide and aluminum rubberized abrasives. Starter kit contains 77 of the most popular styles of this formulation in a handy compartment box. Included are Straight Edge Wheels, Knife Edge Wheels and Cylinders in extra fine to coarse grits, plus a reinforced Mini Mandrel.

110.135 **\$32.95**



101.9812 -
101.9824

101.9862
101.9872



111.754



430.170



130.701



110.135

CRATEX® Abrasives

Grit Textures Coarse - Dark Green, Medium - Brown, Fine - Red, Extra Fine - Light Grey, Pumitex - Pink



Rods - For manual or mechanical applications. Mount in fixtures, chucks or cradles. Dependable automated operations. Sold individually.

Style No.	Dimensions	Coarse	Price	Medium	Price	Fine	Price	Extra Fine	Price
036	6" x 3/16"	—		101.82702*	\$8.40	101.82703*	\$8.40	101.82704*	\$8.40
046	6" x 1/4"	—		101.819*	\$10.05	101.820*	\$9.50	101.821*	\$10.05
066	6" x 3/8"	101.823*	\$11.30	101.824*	\$11.30	101.825*	\$11.30	101.826*	\$8.60
086	6" x 1/2"	101.828*	\$15.75	101.829*	\$15.75	101.830*	\$14.95	101.831*	\$15.75
0126	6" x 3/4"	101.815*	\$24.95	101.816*	\$24.95	—		101.822*	\$21.95



Small Wheels - Available in diameters from 5/8" to 1". Supplied with 1/16" center hole and can be used with mandrels with 3/32" or 1/8" shank in power tools with safe maximum speed of 25,000 rpm. Sold in boxes of 100.

Style No.	Diam.	Thick.	Edge	Coarse	Medium	Fine	Extra Fine	Chromitex	AAA	Pumite	Price
2	5/8"	3/32"	Tapered	101.837*	101.838*	101.839	101.840*	—	—	101.846*	\$59.95
5	1"	1/8"	Tapered	101.842*	101.843*	101.844*	101.845*	—	—	101.841*	\$99.00
53	5/8"	3/32"	Square	101.855*	101.856	101.857*	101.858*	—	—	101.859*	\$70.90
54	5/8"	1/8"	Square	101.860*	101.861*	101.862*	101.863*	—	—	—	\$79.95
59	5/8"	1/4"	Square	101.849*	101.850	101.851*	101.852*	—	—	—	\$79.95
74	7/8"	1/8"	Square	101.865*	101.866*	101.867*	101.868*	101.870*	101.871*	101.869*	\$79.95
80	1"	1/8"	Square	101.875*	101.876*	101.877*	101.878*	—	—	—	\$124.85
88-2	1"	1/4"	Square	101.879	101.880*	101.881*	101.882*	—	—	—	\$149.00

*Has 1/8" hole

CRATEX® Abrasive Assortments

Rubberized abrasives for light deburring, smoothing and polishing. Special formula of pure silicon carbide granules and an oil-resistant rubber bond, they deliver cushion-action performance on a wide range of materials such as metal, plastic, glass and porcelain. Cratex abrasives can be shaped with wheel dressers and do not harden or soften during use or storage. Kits provide a variety of shapes and sizes in various grit textures.

46-Piece Small Wheel Kit

Contains two each of the most popular small wheels, 44 pieces, equally assorted in sizes and textures, plus two mandrels. Packed in handy plastic box. Style #707.

101.752*

\$87.05

123-Piece Time Saver Kit

Practical kit contains 120 wheels and points, plus two wheel mandrels and one point mandrel. Style #776.

101.749*

\$89.95

49-Piece Sanding Kit

45 wheels and points, plus four mandrels, for all of your sanding needs. Style #779.

101.756*

\$63.95

80-Piece All Purpose Kit

Contains the most popular wheels ranging from 5/8" to 1" in diameter, and points from 5/8" to 1" in length, along with 2 wheel mandrels and 2 point mandrels. Packed in handy plastic box. Style #777.

101.753*

\$89.95

26-Piece Introductory Kit

A popular selection of wheels and points, in 5/8", 7/8" and 1" diameters, various grit textures, plus one each point and wheel mandrels. In a handy box. Style #773.

101.750

\$38.75



Emery Paper, Cloth & Accessories

Metalite Emery Cloth

Cloth sheets 9" x 11" with extra sharp particles for faster cutting.

No.	Grit	Price Each
111.276	320 Fine	\$2.80
111.277	240	\$2.20
111.278	180	\$2.85

Emery Cloth

Cloth sheets 9" x 11" with grits from fine to very coarse.

No.	Grit	Price Each
111.269	Fine	\$2.95
111.270	Medium	\$2.30
111.271	Coarse	\$3.55

Emery Paper

Sheet size 9" x 13³/₄". Grit 4/0 is the finest and 3 is the coarsest.

Grit	Mesh	Individual Sheets	Each	Box/100	Box
4/0	800	111.0776 4/0	\$1.50	111.368	\$37.75
3/0	600	111.0776 3/0	\$1.50	111.369	\$37.75
2/0	500	111.0776 2/0	\$1.50	111.370	\$34.95
1/0	400	111.0776/0	\$1.50	111.371	\$36.70
1	280	111.0776/1	\$1.50	111.374	\$36.70
2	240	111.0776/2	\$1.50	111.375	\$38.80
3	180	111.0776/3	\$1.50	111.376	\$41.95

3M Abrasive Papers for Platinum

405N gray open coat papers for pre-polishing platinum. 8" x 10".

101.281*	Tri-M-Ite 360 grit	\$1.70/3pk
101.282*	Tri-M-Ite 400 grit	\$1.40/3pk

Garryflex Gentle Cleaning and Polishing Blocks

Multi-purpose cleaners, impregnated throughout with sharp abrasive grit. Use on steel, iron, aluminum, plastics, ceramics, paintwork, etc. For finer results use with water, liquid soap, mineral spirits or paraffin. Blocks measure 3¹/₈" x 2" x 7/8".

Number	Description	Grit	Color	Each
100.735	Fine	240	Brown	\$12.95
100.736	Medium	120	Black	\$12.95

3M Imperial™ Wet or Dry Sheets

Special resin-over-resin bonding resists heat and holds the abrasive particles for a more uniform cut. Highly wear-resistant and waterproof. All sheets are silicon carbide and can be use wet or dry. Lowest grit is the coarsest. Sheets are 9" x 11".

Number	Grit	Pack of 10	Number	Grit	Pack of 10
101.284	180	\$21.95	101.290	1000	\$20.50
101.285	220	\$21.95	101.291*	1200	\$24.95
101.286	280	\$21.95	101.292	1500	\$24.95
101.287*	320	\$21.95	101.293	2000	\$24.95
101.288*	400	\$21.95	101.294*	2500	\$24.95
101.289*	600	\$21.95			

Slurry Strips

Slurry coated polishing strips are strong and durable for wet or dry applications. Silicon carbide abrasive, rayon sheets, and a unique proprietary backing material sets these apart from traditional polishing paper, and results in a consistent uniform finish. Nine grits in each pack. Twelve strips per sheet.

1.875" W x 7" L

101.022	\$17.95
---------	---------



101.276 -
101.278



101.281
101.282



100.735
100.736



101.284 -
101.294

360 Grey
400 Orange
600 Brown
800 White
1000 Red
1200 Green
1500 Purple
2000 Yellow
4000 Blue

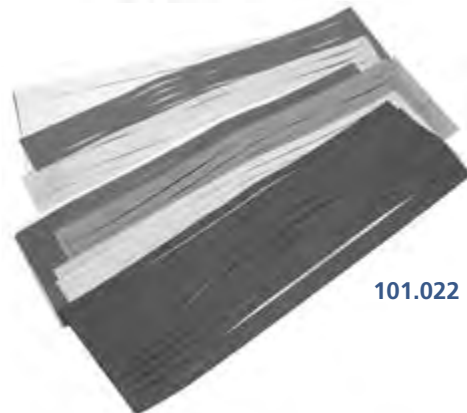

101.022

111.340 -
111.347



Flat Emery Sticks

Emery paper glued to wood handles, 11" long x 3/4" wide. Grits run from 4/0 (finest) to 3 (coarsest).

No.	Grit	Each	No.	Grit	Each
111.340	4/0	\$1.70	111.344	1	\$1.70
111.341	3/0	\$1.70	111.345	2	\$1.70
111.342	2/0	\$1.70	111.346	3	\$1.70
111.343	1/0	\$1.70	111.347	4	\$1.70

111.570

SANTAPER Sticks & Belts

Reach detailed, hard-to-reach areas. Plastic tapered stick holds a replaceable 1/4" wide sanding belt. 360° rotating belt exposes a new sanding surface, efficiently using the entire belt.

Santaper Kit

Includes three sticks and fifteen belts, 3 each of all 5 grits.

111.570 **\$25.85**

110.100



Santaper Sticks

No.	Color	Grit	Each
111.571	Red	120	\$4.35
111.572	Blue	240	\$4.35
111.573	Green	320	\$4.35
111.574	Yellow	400	\$4.35
111.575	Black	600	\$4.35

Santaper Belts

No.	Grit	Pack of 10
111.576	120	\$14.55
111.577	240	\$14.55
111.578	320	\$14.55
111.579	400	\$14.55
111.580	600	\$12.50

Half-Round Buffing Sticks

Ideal for finishing rings, half-round sticks also have abrasive on the flat side. Set of 6 assorted grits, 6/0 - 2 on wood handles. 9" long. Half-round chamois buff 3-pack also available.

110.100 Abrasive Buff Set of 6 **\$8.95**

170.000 Chamois Buff Pack of 3 **\$6.50**

111.350



Polishing Stick & Strips

Plastic handle, 10 1/2" long, holds emery paper or cloth 11" x 1". Strips can easily be replaced. Includes 2 strips, grit 120 and 240.

111.350 Stick & Strips **\$22.75**

111.351 Refills in 12 assorted grits **\$15.55**

110.190 -
110.193



Abrasive Rolls for sanding sticks

Aluminum oxide resin bond abrasive is the perfect width for sanding sticks. Fray resistant cloth works with our 111.350 stick. 50 yards long, 1" wide.

110.190 120 grit **\$37.75** | **110.192** 240 grit **\$37.75**

110.191 180 grit **\$37.75** | **110.193** 320 grit **\$37.75**

171.094
171.100



Felt & Chamois Hand Buffs

Hard felt or chamois strips mounted on wood handle 11"L x 7/8"W. For cleaning and polishing metals and stones.

171.094 Chamois **\$5.75 ea 12 @ \$4.75 ea**

171.100 Felt Buff **\$6.25 ea 12 @ \$5.20 ea**

640.4056.6



BERGEON Leather Buff Stick

Soft leather mounted on a wooden stick. 8 1/2" long x 6mm wide. Swiss made 1282-D by Bergeon.

640.1282.D **\$8.95**

640.1282.D

Protectors for Buff Stick

Clear plastic sheath keeps buff clean and protected when not in use. 5 1/4" long.

640.4056.6 Bergeon 4056-6, 6mm **\$7.25**

640.4056.12 Bergeon 4056-12, 12mm **\$7.95**

3M™ No-Lap Silicon Carbide Abrasive Bands

Glue bonded for fast cutting. Far outlasts lapped bands. All are 1/2" long. Grits: Coarse (100), Medium (180), Fine (320).

Number	Grit	Diam	100	Number	Grit	Diam	100
110.217	Fine	1/4"	\$15.00	110.223	Fine	1/2"	\$15.75
110.218	Med	1/4"	\$15.00	110.224	Med	1/2"	\$15.75
110.219	Coarse	1/4"	\$15.00	110.225	Coarse	1/2"	\$15.75
110.220	Fine	3/8"	\$15.00	110.226	Fine	3/4"	\$17.75
110.221	Med	3/8"	\$15.00	110.227	Med	3/4"	\$17.75
110.222	Coarse	3/8"	\$15.00	110.228	Coarse	3/4"	\$17.75

Abrasive Band Arbors

Rubber heads on 3/32" and 1/8" shanks.

Shank Diameter		For Band	Diameter	Price
3/32"	1/8"			
111.200	111.201		1/4"	\$3.50
111.204	111.205		3/8"	\$3.50
111.208	111.209		1/2"	\$3.50
—	111.211*		3/4"	\$3.50

Abrasive Band Set

Two arbors with 1/4" and 3/8" diameter and 3/32" shank, and 12 assorted abrasive bands.

111.213 **\$16.60**

3M™ Resin Bonded Abrasive Cartridge Rolls

Rolled aluminum oxide 3M abrasives wear away to expose fresh sanding layers as they are used. Excellent for finishing shanks inside and out. Long lasting. 3/4" long, 1/2" diameter, 1/8" hole.

110.160	100 Grit	\$8.50/25	4 pks. of 25@	\$7.50/pk
110.161	120 Grit	\$8.50/25	4 pks. of 25@	\$7.50/pk
110.162	180 Grit	\$8.50/25	4 pks. of 25@	\$7.50/pk
110.163	320 Grit	\$8.50/25	4 pks. of 25@	\$7.50/pk
110.164	Asst of All Four, 25 each			\$29.95

Mandrels for Abrasive Cartridge Rolls

110.178 3/32" Shank **\$2.95**

110.174 1/8" Shank **\$2.95**



Birchwood Arbor

For coating with adhesive and rolling in abrasive to form a 7" polishing stick. 1/4" arbor hole for tapered spindle mounting.

111.266 **\$22.95 dozen**

Split Wood Mandrel

Slot holds emery paper so it can be wound around mandrel to desired thickness and secured with rubber band.

110.306 **\$1.90 each**

Split Mandrels for Flexshaft Handpiece

Emery paper is wound around mandrel for polishing smaller pieces. 2 1/4" long, with 3/32" shank to fit in handpiece.

111.308 Straight **\$17.65 per dozen**

111.309 Tapered **\$15.05 per dozen**



110.213

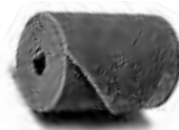

110.160 - 110.164



110.174
110.178

110.214 - 110.216



**10% DISCOUNT ON
10 PIECES OF THE
SAME GRIT**

Waterproof Polishing Cones

Long-lasting cones for working inside and outside of cast rings and flat parts of cast jewelry. After wearing down, strip off the top layer each time to expose a fresh layer. Use down to a diameter of approximately 6mm. Mounted on standard 2.35mm shafts. Swiss.

110.214 240 Grit **\$2.15**

110.215 320 Grit **\$2.15**

110.216 400 Grit **\$2.15**

Emery Inside Ring Shells

Smooth and polish inside rings. Fit snugly over wood mandrel that is drilled for a tapered spindle. Made in both emery paper and longer lasting cloth. Grits 4/0 (finest) to 3 (coarsest).

Cloth Grit Dozen

111.310 4/0 **\$23.95**

111.311 2/0 **\$25.20**

111.312 1 **\$25.20**

111.313 3 **\$25.20**

Paper Grit Dozen

111.320 4/0 **\$30.50**

111.321 3/0 **\$32.10**

111.322 2/0 **\$32.10**

111.323 1/0 **\$32.10**

111.324 1 **\$32.10**

111.325 2 **\$32.10**

111.326 3 **\$32.10**



111.331

Sanger's® Assortments

111.317 Cloth, 12 Shells assorted **\$25.00**

111.330 Paper, 12 Shells assorted **\$30.50**

111.318* Cloth, 6 Shells assorted w/Mandrel **\$16.85**

111.331 Paper, 6 Shells assorted w/Mandrel **\$16.95**

Wood Mandrel for Sanger's Shells

Held by friction. Also holds rings, chains, etc. when polishing.

110.333 **\$2.75**

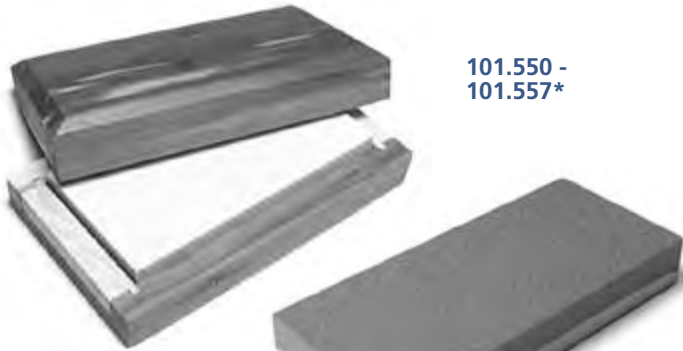

101.550 -
101.557*

101.450 -
101.463



101.608* -
101.611



Norton Pike Oil

Excellent sharpening oil, also used for lubricating hinged or moving parts of hand tools, locks, casters, power tools, mechanical and electrical appliances, sewing machines, sports gear, toys and more. 4.5 oz.

421.480 **\$7.95**

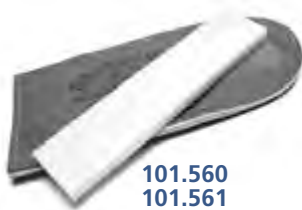

101.560
101.561



101.599



101.604*



111.740 - 111.764



111.716*

Hard Arkansas Stones

Natural, close-density oilstones are unequalled for sharpening knives, gravers, etc. Unmounted or mounted in cedar boxes.

Translucent (Extra Fine).Hard (Fine)

Mounted	Diameter	Price	Mounted
101.550*	3" x 1" x 1/2"	\$29.75	101.551* 4" x 2" x 1/2" \$29.95
101.552*	4" x 2" x 1/2"	\$89.95	101.553* 5" x 2" x 1/2" \$44.40
101.554*	5" x 2" x 1/2"	\$89.95	101.555 6" x 2" x 1/2" \$59.65
			101.557* 8" x 2" x 1/2" \$74.10

Combination & Single Grit India Bench Stones

These hard, sharp, tough, aluminum oxide stones are available in various shapes and grits. Long recognized for the clean, sharp surfaces they produce on tools, dies, blades, molds and almost any other metal piece requiring sharpening or smoothing.

Use on both sides. Combination stones have fine grit on one side, coarse on the other.

Combo	Size	Price	Medium	Size	Price
101.450	4" x 1 3/4" x 5/8"	\$15.95	101.461	4" x 1" x 1/2"	\$11.85
101.451	6" x 2" x 1"	\$25.60	101.462*	6" x 2" x 1"	\$28.90
101.452	8" x 2" x 1"	\$30.25	101.463	8" x 2" x 1"	\$32.00
Fine Grit					
101.456*	4" x 1" x 1/2"	\$11.85			
101.457	6" x 2" x 1"	\$27.10			
101.458*	8" x 2" x 1"	\$31.25			

Arkeram Bench Stones

Made from Arkansas stone powder, solidified by fire. With more cutting ability than regular Arkansas stones. Come in hardwood box and can be used on both sides with oil.

No.	Diameter	Price
101.608*	4" x 1" x 1/2"	\$49.95
101.609*	5" x 2" x 7/8"	\$66.25
101.610*	6" x 2" x 1"	\$76.50

Hard Arkansas Penknife Pieces

Unmounted stones in leather pouch. Translucent (extra fine)

No.	Size	Price
101.560*	3" x 1" x 1/4"	\$25.50
101.561	4" x 1" x 1/4"	\$42.90

Hard Arkansas Wheels

Wheels are 1/4" thick.

No.	Style	Diameter	Mandrel	Price
101.599	Mounted	3/4"	3/32"	\$30.25
101.604*	Unmounted	2"	—	\$79.95

Silicone Carbide Stones

Specially shaped stone for dressing and truing wheels that have become rounded or chipped. 6" x 1" x 1".

111.716* **\$22.40**

Silicon Carbide Wheels

Grinding stones for mild steel, soft metals such as copper, bronze, gold, silver, etc., and some gemstones. Available Fine (180) and Medium (150) grits. Wheels rated not to exceed 8500 RPM.

Fine	Medium	Diameter	Thickness	Hole	Price
111.740	111.741	2"	1/4"	1/4"	\$17.65
111.754	111.755	3"	1/2"	3/8"	\$23.10
111.760*	111.761	3"	1/2"	1/4"	\$22.95
111.763*	111.764	3"	1/2"	1/2"	\$22.95

India Slips

Hard, sharp, tough, aluminum oxide stones available in 6 shapes, in fine or medium grits.

Number	Grit	Shape	Diam.	Price
101.478	Fine	Knife	4" x 1"	\$15.50
101.486*	Fine	Rnd Edge	4" x 1"	\$10.35
101.489	Fine	Square	4" x 1/4"	\$7.35
101.472	Med.	Flat	4" x 1/2"	\$14.95

Number	Grit	Shape	Diam.	Price
101.479*	Med.	Knife	4" x 1"	\$12.90
101.485*	Med.	Round	4" x 3/8"	\$13.95
101.490*	Med.	Square	4" x 1/4"	\$6.95
101.497	Med.	Square	4" x 1/2"	\$8.40

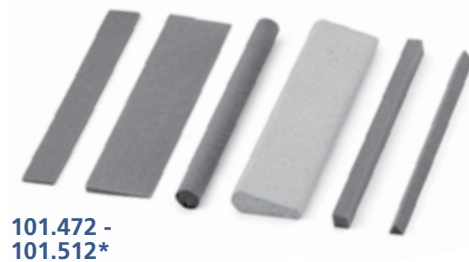

101.472 - 101.512*

Hard Arkansas Slips

Variety of shapes and sizes.

No.	Shape	Diameter	Price
101.574*	Beveled	3 1/2" x 3/8" x 1/2"	\$26.55
101.578	Pointed	4" x 1/4"	\$43.35

No.	Shape	Diameter	Price
101.580	Square	2 1/2" x 1/8"	\$12.10
101.588	Triangular	2 1/2" x 1/8"	\$14.15



101.574* - 101.588

Ruby Midget Files

Used for high detail and ultra-precision work. They may be broken off and cemented onto a holder or used with a pin vise. Fine grit only.

No.	Shape	Length x Thick	Price
101.431*	Square	2" x .04"	\$14.45
101.432	Round	2" x .04"	\$14.50
101.433	Triangular	2" x .08"	\$17.85
101.434*	Square	4" x .08"	\$31.90
101.435*	Round	4" x .08"	\$34.95
101.436*	Round	4" x .12"	\$35.25

No.	Shape	Length x Thick	Price
101.437*	Flat	2" x .12" x .001"	\$18.40
101.438*	Half-Round	4" x .16"	\$54.90
101.439*	Barrette	4" x .2" x .06"	\$49.95
101.440*	Crossing	4" x .16" x .06"	\$33.75
101.441*	Triangular	4" x .12"	\$51.25



101.445 Kit

Midget File Kit

Contains one of each file listed above, plus one double-ended holder with two reversible collets. For high detail and ultra-precision work.

101.445 **\$249.00**

Tru-Stone for Finishing

Quickly reshapes and resurfaces abrasive stones to like-new condition. A very hard and coarse silicon carbide stone with 4 different sized half-round grooves on one side measuring 1/16", 1/8", 3/16", and 1/4". Overall 3 1/2" x 1 3/8" x 9/16".

101.408 **\$10.05**



101.406

Dresser Stick for Diamond Wheels

Provides the proper grit for dressing, truing, roughing and finishing diamond wheels. 100 grit. 6" x 1/2" x 1/2".

101.406* **\$13.40**

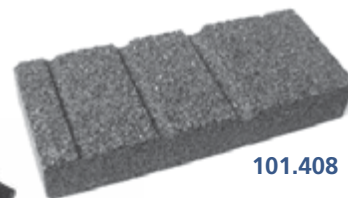

101.408

Tear-Off Emery Sticks

Six layers of adhesive emery paper strips applied to the laminated sanding stick, hold firm and can be easily taken off. Emery section is 3-3/4" inches (10.5cm) long; overall length 8" (20cm).

110.353	1000 grit	110.357	400 grit
110.354	120 grit	110.358	600 grit
110.355	240 grit	110.359	800 grit
110.356	320 grit		



110.353-110.359

ORDER BY SKU ABOVE **\$3.50**

Versatile Diamond Hones shape and sharpen your tools

Use to dress or reshape abrasive points by lightly touching a rotating point to the diamond surface. Also for hand smoothing and shaping glass, metal, stone, bone and plastic, and for sharpening steel instruments. 3/4" x 2" diamond pad on 6" plastic color coded handle.

110.290	1200 grit	Blue	\$10.95
110.291	600 grit	Red	\$10.95
110.292	400 grit	Purple	\$10.95
110.293	250 grit	Black	\$17.50



110.290 - 110.293



111.426-
111.440



110.975
110.975

Color coded for quick selection

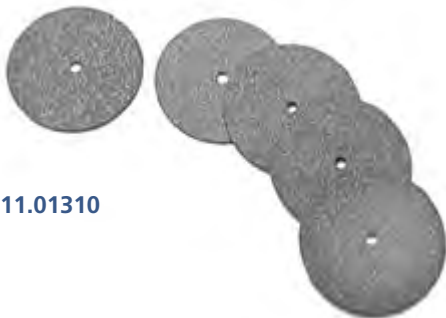

111.01310



101.541 - 101.544



111.778 - 111.782

Mizzy Heatless Wheels

Hard, square-edged wheels used for deburring and finishing. Loose, coarse construction makes the grinding process cool, and suitable for materials such as plastic and metal. Can be used to produce a matte finish. Pin-hole for mounting on mandrel. May be trued with a file. Packed in tubes of 50. Diameters:

1/2"	5/8"	3/4"	7/8"	1"	Thick.	50/pk
111.426	111.429	111.432	111.435*	111.438	1/16"	\$59.95
111.427	111.430	111.433	111.436	111.439	1/8"	\$59.95
111.428	111.431	111.434*	111.437*	111.440*	3/16"	\$59.95

Ceramic impregnated wheels work faster, last longer

Freedom polishing wheels are ideal for smoothing and polishing platinum, gold, silver and other precious metals. Color coded wheels range from super fine to coarse grits. Assortment includes 10 wheels, two each 120, 180, 320 and 500 grits, and one each 1000 and 1500 grits. Dimensions: 7/8" x 1/8".

110.975	\$11.95
---------	---------

High Speed Separating Discs

Resin-bonded aluminum oxide is fast, cool, odor-free and long-lasting. Cuts all metals smoothly and rapidly. Measures 7/8" x .025". Box of 100.

111.01310	\$12.25
-----------	---------

Flexible Separating Discs

Extra thin discs for cutting gold and porcelain. 7/8" diameter.

111.900	.009" Box of 25	\$15.75
111.901	.009" Box of 100	\$52.95
111.902	.006" Box of 25	\$16.65
111.903	.006" Box of 100	\$52.95

Unmounted Cut-Off Wheels

Made of rubber-bonded aluminum oxide grains. Excellent for sprue removal and other cut-off operations. Mount on mandrels. Sold in boxes of 100.

No.	Diameter	Thickness	Per 100
101.541	7/8"	.010"	\$61.45
101.537	7/8"	.030"	\$39.45
101.538	1"	.030"	\$41.80
101.542*	1"	.015"	\$50.35
101.539*	1 1/4"	.033"	\$42.30
101.543*	1 1/4"	.062"	\$39.90
101.540*	1 1/2"	.025"	\$26.50

Damascus Silicone Carbide Separating Discs

Thin grinding disks cut on the edge, and on one or both sides. Available in 3/4", 7/8" and 1" diameters, with pin hole for mandrel mounting. In boxes of 100.

No.	Diam.	Thick.	Cutting Sides	Price Per 100
111.778	3/4"	.022"	Both	\$12.35
111.779*	3/4"	.020"	One	\$12.35
111.777	7/8"	.005"	Both	\$69.95
111.776	7/8"	.015"	Both	\$39.75
111.780	7/8"	.022"	Both	\$11.75
111.781*	7/8"	.020"	One	\$12.35
111.782	1"	.022"	Both	\$12.35

Moore's Abrasive Sanding Discs

Aluminum oxide grit, mounted on thin backing, provides excellent results in sanding and smoothing operations. The flexible backing allows accessibility to hard-to-get-at areas. Use with 3/32" mandrel No.101.740. Price per 100 Discs (comes in 2 boxes of 50 each).

Coarse	Medium	Fine	Diameter	Per 100
101.01077	101.01082	101.01087	1/2"	\$10.95
101.01075	101.01080	101.01085	3/4"	\$10.95
101.01076	101.01081	101.01086	7/8"	\$10.95

Moore's Sanding Discs Master Packs

Sold in master pack - 12 boxes of 50 discs per box.

Coarse	Medium	Fine	Diameter	Per 600
101.01077/B	101.01082/B	101.01087/B	1/2"	\$70.25
101.01075/B	101.01080/B	101.01085/B	3/4"	\$70.25
101.01076/B	101.01081/B	101.01086/B	7/8"	\$77.50

Yellow Abrasive Sanding Disc Assortment

Exclusive aluminum oxide grit and thin flexible backing designed for jewelry applications. Provide exceptionally long life, outstanding sanding and smoothing results, and accessibility to hard-to-get-at areas. 3/4" or 7/8" diameter. Use with 3/32" mandrel. Assortment contains 25 fine, 25 coarse, and 50 medium, 7/8" sanding discs, plus mandrel. Press-on/flip-off center holes.

101.712 **\$18.70**

Individual Discs - Supplied in tubes of 100.

Diameter	Coarse Grit	Medium Grit	Fine Grit	per 100
3/4"	101.714	101.715	101.716	\$14.75
7/8"	101.718	101.719	101.720	\$15.30

Magnum Sanding Discs

Aluminum oxide on reinforced plastic backing which increases life of disc 2 to 3 times that of a paper-backed disc. Brass centers for use with press-on/flip-off 3/32" mandrel No.101.740. Pack of 100.

Fine	Medium	Coarse	Diameter	Per 100
101.01120	101.01123	101.01126*	7/8"	\$15.50
101.01121	101.01124	101.01127	3/4"	\$15.50
101.01122	101.01125*	101.01128*	5/8"	\$14.50

Adalox Pin Hole Sanding Discs

Aluminum oxide grit mounted on flexible backing allows for easy accessibility into those hard to reach places. With pin hole centers for use with mandrel No.431.128. Packs of 100 discs.

Coarse	Medium	Fine	Diam.	Per 100
	101.01101	101.01102*	1 1/2"	\$20.55
101.01103*	101.01104	101.01105	7/8"	\$9.45
431.128	Reinforced mandrel 3/32"			\$14.25 dz

Press-On/Flip-Off Mandrel

High quality steel with 3/32" shank.

101.740 **\$2.75**



See page 149 for a full selection of Flex-Shaft and Drill mandrels.



170.845



170.846



640.1199



640.6723.240LP



640.6168



130.025
130.026



171.969



171.975*

Linen Polishing Buff

Special white fine linen buff is recommended by luxury watch brands. Features 72 plies, 150mm (6") in diameter and 3/4" thick. With leather center and brass screws. Made in Germany.

170.845

\$38.95

Cotton Polishing Buff

Merard's Luxor buff is made of closely woven fine natural French cotton. Ideal for fine finishing of delicate pieces. 3/4" thick, 6" diameter wheel has a 6mm hole. Made in France.

170.846

\$29.95

Genuine BERGEON 1199 Felt Buff

White felt polishing buff used by Rolex for polishing watch cases. This buff preserves the geometry of a case by removing the least amount of metal. 3 1/4" Diameter x 3/4" Thick. Swiss made.

640.1199

\$37.75

Genuine BERGEON 6723.240LP Polishing Wheel

Flexible silicon carbide, medium hardness, 240 grit, measures 4" Diameter x 3/4" Thick. Swiss.

640.6723.240LP

\$52.50

BERGEON Artifex Abrasive Wheels

ARTIFEX Silicon carbide wheels for grinding, polishing, satin finishing of all precious metals. 4" Diameter, 3/4" Thick, 1" (25mm) Hole Diameter with a 3/8" (10mm) reducer hole. Maximum speed: 1900 RPM. Swiss made.

640.6168D Coarse SD Bergeon 6168D \$85.95

640.6168E Semi-Coarse SD Bergeon 6168E \$85.95

640.6168F Fine Bergeon SD 6168F \$85.95

Artifex Abrasive Wheels

ARTIFEX Elastic Bonded Abrasive Wheels. Soft, Coarse Grit for pre-polishing. 100mm x 20mm x 25mm Hole. Made in Germany.

130.025 SC 46 WP, 46 Grit \$56.95

130.026 SC 80 WP, 80 Grit \$56.95

Paramount™ Felt Split Laps

The standard of excellence in split lap performance. Each wheel is balanced, with holes in the precise center, to ensure smooth operation, and perfectly concentric slits provide outstanding visibility of the product being polished. 1/2" thick with beveled edges. Each lap is packaged in plastic to eliminate discoloration and prevent breakage during shipping.

171.956* Medium 6" \$64.00

171.962* Medium 7" \$59.75

171.968* Medium 8" \$66.95

171.957* Hard 6" \$63.95

171.963* Hard 7" \$73.50

171.958 Rock Hard 6" \$78.70

MX Split Lap Wheel

Multi-laminated, flexible, cotton split-lap impregnated with aluminum oxide grains. Smooth, controlled, cool grinding action produces a consistent finish on most metals. Maximum rating is 6050 RPM. Measures 6" x 1/4", with 3/8" arbor hole.

171.975*

\$53.95

Genuine Bergeon Swiss Abrasive Wheels

Radial leaves for brilliant or matte polishing of metals. Ideal for cleaning, stripping, deoxidation, retouching old objects. Fine grain brushes used without a polishing composition. 4" diameter, 7/8" thick. Recommended speed 2800 RPM, 5500 maximum. Silicium Carbide gray-green color for a slightly matte satin finish, or Aluminum Oxide red-brown color for a brilliant satin finish.

100.747 Silicium Carbide Bergeon 6085-E2 Fine	\$34.75
100.748 Aluminum Oxide Bergeon 6085-F2 Fine	\$37.95

Bergeon Silicium Carbide Wheel for Very Fine polishing

Abrasive brush with radial leaves for applying a very fine satin finish on watch cases. Ideal for cleaning, stripping, de-oxidation, retouching of gold objects. Use without polishing products or paste. Suggested speed 2800 RPM, maximum 5500 RPM. 4 1/4" diameter, 3/4" thick, 6mm (7/32") hole. Bergeon 6085-E3

100.749 Very Fine	\$37.95
--------------------------	----------------

Bufflex Buffs - Recommended by leading watch brands

Produces a perfect satin finish on watch cases and bands. Use on flat, convex and concave surfaces. No need for compound - works wet or dry on metals for cleaning, deoxidation, decorative satining & final finish. Use on stainless steel, plastic, laminates, paint, varnish, finishes. 3 7/8" diameter, 1 3/16" thick, 1400 - 2800 RPM.

170.839 Very Fine	\$29.95
170.843 Fine	\$29.95
170.844 Medium	\$29.95

Rockville Scotch Brite Flap Wheels

Non-woven flap wheel for a satin finish on watch bands and cases. Ideal for stainless steel. 110mm Ø. 30mm thick, 6mm (7/32") hole.

100.752 Silicon Carbide Fine
100.753 Silicon Carbide Very Fine
100.754 Silicon Carbide Super Fine
100.755 Silicon Carbide Ultra Fine
100.762 Aluminum Oxide Fine
100.763 Aluminum Oxide Very Fine

\$11.95 each

Satin Finish Buffs

Synthetic fiber, used dry, produces a satin finish on gold, silver and other metals. Buffs are 2 ply and have leather patches in center to provide firm grip on tapered spindle.

No.	Diam.	Ply	Grade	Price	No.	Diam.	Ply	Grade	Price
171.891	4"	2	Med	\$4.75	171.896	4"	3	Fine	\$5.25
171.892	4"	2	Crse	\$4.75	171.897	3"	3	Med	\$5.25
171.893	4"	2	Fine	\$4.95	171.898	3"	3	Crse	\$10.95
171.894	4"	3	Med	\$6.25	171.899	3"	3	Fine	\$4.95
171.895	4"	3	Crse	\$13.25					

3M™ Clean & Finish Wheel

Aluminum oxide wheel provides a uniform satin finish. Wheels can be stacked to build the thickness you need. Works fast to give you the right cut every time. 6" diameter, 1/4" thick, hole size 1/8".

101.311 Medium grit (or mesh)	\$8.95
--------------------------------------	---------------

Matte Finish Wheels

Bear-Text wheels have nylon fibers impregnated with abrasive granules. Use to obtain matte finishes on metal, wood and plastic. 3" diameter, 3/4" thick, 1/4" arbor hole.

171.870 Fine	\$17.95
171.871 Medium	\$21.70

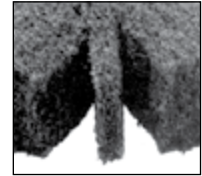

100.747
100.748
100.749



170.843
170.844
170.849



100.752 -
100.755

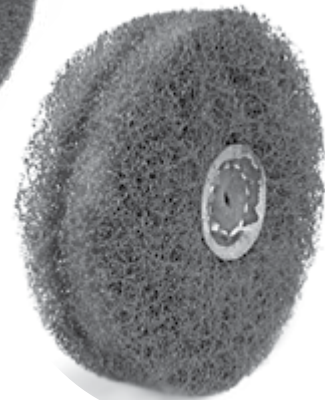

171.891 -
171.899



101.311

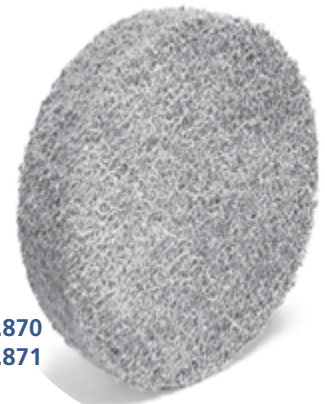

171.870
171.871



171.571 -
171.589

171.841



171.566 -
171.53102



171.524 -
171.527



170.960



171.01220 -
171.01222



171.135 -
171.141

DIXCEL® Regular Muslin Buffs, Shellac Centers

Use with abrasive compounds such as emery and tripoli.

No.	Diam	Ply	Rows	Price	No.	Diam	Ply	Rows	Price
171.571*	2"	30	2	\$2.25	171.584	5"	45	3	\$4.75
171.573*	2½"	30	2	\$2.25	171.588	6"	50	4	\$5.95
171.577	3"	35	3	\$2.50	171.589	8"	55	4	\$12.95
171.581	4"	42	3	\$3.25					

Section Muslin Buffs

These buffs have a 6" diameter and are 1/4" thick, with spiral sewing 3/8" apart. They may be grouped to obtain the thickness desired. With pin hole center.

171.841 **\$5.75**

Berry Buffs for high lustre

Fine quality stiff chemically treated fine weave muslin with good cutting action and high compound retention. Ideal for use with aggressive compounds to remove scratches. Provides robust polishing for an amazingly high lustre on all hard metals. Quick action reduces polishing time. Extremely durable and long lasting. The best buff available for final polishing of platinum.

Number	Dia.	Ply	Rows	Price	Number	Dia.	Ply	Rows	Price
171.566	4"	12	7	\$5.25	171.531	4"	40	3	\$7.50
171.567	6"	12	10	\$6.25	171.53101	5"	40	3	\$7.25
171.530	6"	30	4	\$6.25	171.53102	6"	50	4	\$10.75

Orange Buffs

A durable treated muslin that's ideal for use with aggressive compounds to remove scratches from gold. Excellent compound retention. Also provides robust polishing for a high lustre on all hard metals.

Number	Dia.	Ply	Rows	Price	Number	Dia.	Ply	Rows	Price
171.524	3"	50	3	\$3.95	171.528	5"	60	5	\$11.25
171.525	4"	40	3	\$6.25	171.529	6"	50	5	\$12.75
171.526	4"	50	3	\$7.25	171.52901	6"	60	5	\$12.75
171.52601	5"	50	4	\$8.95	171.564	4"	12	7	\$4.50
171.527	5"	40	3	\$8.25					

Bufs for VIGOR Multi-Grinder

3" diameter for No.471.0217.

171.01220	Ex-fine muslin	\$3.95
171.01221	Cotton flannel	\$4.50
171.01222	Felt	\$13.95

Brilliant Buff

100% long strand Egyptian cotton impregnated with a patented chemical for rougeless polishing. Made in France. Excellent for final buffing, leaves an undetectable residue which inhibits tarnish. Non-toxic, non-allergenic. 4 1/2" x 3/4". Hole fits tapered spindles.

170.960 **\$13.50**

DIXCEL® Chamois Buffs

Used with rouge to produce a high finish on soft metals. Stitched with leather patch on center for firm grip on tapered spindle.

No.	Dia.	Ply	Rows	Price	No.	Dia.	Ply	Rows	Price
171.135	1"	5	1	\$5.00	171.139	4"	18	3	\$24.95
171.136	2"	12	2	\$14.75	171.140	5"	18	3	\$32.25
171.137	2½"	12	2	\$12.25	171.141	6"	18	4	\$39.95
171.138	3"	12	3	\$15.00					

DIXCEL® Chemkote Yellow Buffs

A more aggressive, treated muslin helps to remove surface scratches from work.

No.	Dia.	Ply	Rows	Price	No.	Dia.	Ply	Rows	Price
171.550	1"	16	1	\$1.25	171.541	5"	50	3	\$8.25
171.551	3"	30	3	\$2.95	171.542	5"	60	3	\$9.95
171.55101	3"	40	3	\$4.25	171.543	6"	30	4	\$7.50
171.552	4"	30	3	\$4.75	171.544*	6"	40	4	\$8.95
171.553	4"	40	3	\$4.95	171.555	6"	50	4	\$9.25
171.540	4"	50	3	\$6.00	171.545	6"	60	4	\$13.95
171.554	5"	45	3	\$7.75					

Chemkote with Knife Edge and Leather Centers

No.	Dia.	Ply	Rows	Price	No.	Dia.	Ply	Rows	Price
171.562*	3"	9	2	\$3.95	171.563	5"	12	7	\$5.50
171.560	4"	12	5	\$4.75	171.561	6"	12	8	\$6.25

Combed Finex Muslin Buffs, Leather Centers, Loose

For use with rouge to produce a high finish. Available in stitched-type with 3 or 4 rows, or loose-type with one row.

No.	Dia.	Ply	Rows	Price	No.	Dia.	Ply	Rows	Price
171.771	3"	35	1	\$3.50	171.775	5"	45	1	\$5.25
171.773	4"	30	1	\$3.50	171.782	5"	50	1	\$5.75
171.778	4"	36	1	\$2.95	171.783	5"	54	1	\$6.25
171.774	4"	40	1	\$3.75	171.776	6"	50	1	\$7.00
171.779	4"	50	1	\$4.25	171.784	6"	54	1	\$7.50
171.781	4"	60	1	\$4.95	171.777*	8"	55	1	\$12.95

Combed Finex Muslin Buffs, Leather Centers, Stitched

For use with rouge to produce a high finish. Available in stitched-type with 3 or 4 rows, or loose-type with one row.

No.	Dia.	Ply	Rows	Price	No.	Dia.	Ply	Rows	Price
171.751	3"	35	3	\$2.50	171.755	5"	45	3	\$5.50
171.753*	4"	30	3	\$3.75	171.759	5"	50	3	\$5.95
171.754	4"	40	3	\$4.25	171.760	6"	40	4	\$6.25
171.757	4"	50	3	\$4.95	171.756	6"	50	4	\$7.25
171.758	4"	60	3	\$5.25	171.761	6"	60	4	\$8.75

DIXCEL® Finex Muslin Buffs with Knife Edge and Leather Centers

For working into crevices. Use with rouge when buffing.

No.	Dia.	Ply	Rows	Price	No.	Dia.	Ply	Rows	Price
171.643	3"	9	3	\$3.50	171.645	5"	12	7	\$4.95
171.644	4"	12	5	\$4.25	171.646	6"	12	9	\$5.95

DIXCEL® Combed Finex Muslin, Plastic Centers

Unstitched and used with rouge to produce a high finish.

No.	Diameter	Ply	Price	No.	Diameter	Ply	Price
171.716	3"	36	\$3.75	171.721	5"	54	\$6.50
171.717	3"	54	\$4.25	171.722	6"	54	\$7.75
171.718	4"	28	\$3.95	171.723	6"	63	\$8.95
171.719	4"	36	\$4.25	171.724	8"	54	\$11.95
171.720	4"	54	\$4.95				

DIXCEL® Combed Finex Muslin, Shellac Centers

With combed edges for use with rouge.

No.	Dia.	Ply	Rows	Price	No.	Dia.	Ply	Rows	Price
171.621	2 1/2"	30	2	\$2.50	171.632	5"	50	3	\$5.95
171.622	3"	35	3	\$2.50	171.625	5"	55	5	\$6.50
171.623	4"	30	4	\$2.95	171.633	6"	50	4	\$6.95
171.629	4"	40	3	\$3.50	171.626	6"	60	6	\$8.75
171.624	4"	50	4	\$4.25	171.627	6"	70	6	\$9.95
171.630	4"	60	3	\$4.25	171.628*	8"	70	7	\$15.95
171.631	5"	45	3	\$4.95					



171.540 - 171.555



171.560 - 171.563



171.771 - 171.784



171.751 - 171.761



171.621 - 171.628



171.643 - 171.646

171.716 - 171.724



171.200 - 171.208



171.615 - 171.619



171.704 - 171.706



171.707 - 171.709



330.983



330.982



640.7116

DIXCEL® Mini Finex Muslin Buffs

For polishing small, difficult to reach areas. Use with mandrels. Sold by the dozen.

No.	Dia.	Ply	Rows	Price	No.	Dia.	Ply	Rows	Price
171.615	7/8"	16	1	\$7.95	171.618	1 1/2"	16	3	\$9.95
171.616	1"	16	1	\$8.25	171.619	2"	16	4	\$11.75
171.617	1 1/4"	16	3	\$9.25					

DIXCEL® Cotton Flannel

Used with rouge for buffing. Soft cotton flannel, stitched, shellac hardened centers.

No.	Dia	Ply	Rows	Price	No.	Dia	Ply	Rows	Price
171.200	2"	25	2	\$2.75	171.206	5"	30	3	\$5.95
171.201	2 1/2"	25	2	\$2.95	171.207	6"	30	4	\$6.75
171.203	3"	30	3	\$3.95	171.208	8"	30	4	\$11.50
171.205	4"	30	3	\$4.75					

VIGOR® Super Buffs, Shellac Center

Treated with a unique process which removes all impurities and makes the cloth finer, virtually lint-free. 4 Stitched Rows.

No.	Diameter	Ply	Price
171.704	4"	50	\$7.50
171.705	5"	55	\$8.75
171.706	6"	60	\$13.95

VIGOR® Super Buffs, Plastic Center

Compound holds better on Vigor buffs for a smoother, more uniform finish and superior coloring.

No.	Diameter	Ply	Price
171.707	4"	36	\$8.95
171.708	5"	54	\$11.95
171.709	6"	54	\$15.50

All Metal Buff Rake

Clean and restore your buff to like-new condition. As a buff gets older, it accumulates compound and metal which can scratch the surface of soft metals. This rake has 3 rows of steel teeth and measures 8" long overall. Safety note: Apply light pressure to the buff while holding the rake tightly with both hands.

330.983 **\$17.75**

Buff Rake with Wood Handle

Use to restore your buff to like-new condition. As a buff gets older, it accumulates compound and metal which can scratch the surface of soft metals. This rake has 4 rows of steel teeth mounted on a wood handle. 15" long overall. Safety note: Apply light pressure to buff while holding the rake tightly with both hands.

330.982 **\$13.75**

Bergeon Buff Rake

Use to card or scrape polishing buffs before use to make the fabric softer and allow it to hold more polishing compound. Simply hold the rake firmly with both hands and scrape the surface of the rotating buff. Then finish the buff with a cutter or 40 or 80 grit coarse emery paper to soften and remove threads which remain. Once these steps have been completed you will have a buff that should not vibrate and be very soft to the touch. Swiss made by Bergeon, 7116.

640.7116 **\$239.00**

Mini-Muslin Buffs

All have 1" diameter. Mounted buffs have a 3/32" shank.

Number	Type	Hole	Ply	Dozen
--------	------	------	-----	-------

Chemkote

171.912*	Mounted	----	8	\$8.25
171.910*	Unmounted	3/32"	8	\$6.25

Muslin

171.913	Mounted	----	12	\$8.75
171.911*	Unmounted	3/32"	12	\$5.95

Miniature Buff Assortment

Contains two 3/32" mandrels which can be used on flexshafts, along with six of the most popular items: 1 chamois buff, 1 muslin wheel, 1 felt cone and 3 felt wheels in a handy plastic box.

171.126	\$9.05
----------------	---------------

VIGOR® Midget Super Buff

100% cotton treated and abrasive elements removed to last longer. Hardly frays, using less compound. 16 ply.

No.	Diameter	Rows	Dozen
171.700	7/8"	1	\$22.25
171.701	1 1/4"	2	\$23.25
171.702	1 1/2"	3	\$24.95
171.703*	2"	4	\$26.95

DIXCEL® Miniature Chamois Buffs

For use with mandrels. .

171.132*	5/8" diameter, 3 ply	\$23.95 dz
171.134*	3/4" diameter, 3 ply	\$24.25 dz

Box of 25, 3 ply wheels contain 16 wheels 5/8" diameter and 9 wheels 3/4" diameter.

171.129*	\$39.95 per 25
-----------------	-----------------------

Mounted Midget Felt Buff

Solid Felt buff on 3/32" shank. 1" diameter.

171.115	\$16.10 dz
----------------	-------------------

Special Shape Muslin Buffs

Well suited for polishing interior and broad surfaces.

No.	Shape	Diam.	Length	Price
171.610	Cylinder	2"	2 1/4"	\$23.75
171.831	Goblet	2"	1 1/2"	\$16.50
171.832*	Goblet	2 1/2"	1 3/4"	\$17.95
171.833*	Goblet	3"	1 3/4"	\$20.25
171.834*	Goblet	4"	2"	\$24.95
171.852*	Tapered	3/4 - 2"	1 3/4"	\$22.25
171.853	Tapered	1 - 2 1/2"	2 1/4"	\$24.95



171.910 - 171.915

171.126

171.700 - 171.703

171.132
171.134
171.129

171.115

171.610

171.831

DIXCEL® Felt Bobs

100% wool, ideal for precision deburring, polishing and finishing. Can be charged with compounds. Specifically designed for use with flex-shafts and similar tools. The unmounted versions have a pinhole for mandrel mounting.



171.220 - 171.232

171.238



171.280



171.266



171.277



171.376



171.345



171.483

Cylinder Shape

Hard	Price	Medium	Price	Type	Diam.	Face	Mandrel
171.220	\$2.25	171.221	\$2.40	MP-1	1/4"	1/4"	1/8"
171.222	\$2.40	171.223*	\$2.40	MP-2	1/4"	3/8"	1/8"
171.224	\$3.05	171.225*	\$2.75	MP-3	3/8"	3/8"	1/8"
171.226	\$3.55	171.227*	\$3.00	MP-4	3/8"	1/2"	1/8"
171.228	\$3.55	171.229	\$3.55	MP-5	1/2"	1/2"	1/8"
—	—	171.230	\$3.50	MP-6	1/2"	3/4"	1/8"
—	—	171.231	\$4.25	MP-7	1/2"	1"	1/8"
171.232	\$4.50	171.233	\$4.25	MP-8	3/4"	3/4"	1/8"
—	—	171.239*	\$2.25	P-8	3/4"	3/4"	None
—	—	171.234	\$5.10	MP-9	3/4"	1"	1/8"
—	—	171.235*	\$5.60	MP-11	1"	1"	1/4"

Round Felt Cones

For polishing objects with rounded surfaces. Solid felt with pinhole center. Use with mandrel.

No.	Diameter	Length	Price
171.280	1/2"	1"	\$2.25
171.281*	3/4"	1 1/2"	\$3.45
171.282	1"	2"	\$4.60

Miniature Pointed Felt Cones

For polishing small objects that have concave surfaces. Made of solid felt with hard density. Use with mandrel. Sold by the box.

25 Pieces	Price	Box 100	Price	Diameter	Length
171.266	\$16.80	171.267*	\$49.95	1/4"	3/8"
171.271	\$18.65	171.272*	\$56.00	1/4"	1/2"

Pointed Felt Cones

For polishing objects that have concave surfaces. Made of solid felt with pin hole center. Use with mandrel.

No.	Diameter	Length	Price
171.276	1/2"	1"	\$2.70
171.277	3/4"	1 1/2"	\$4.20
171.278	1"	2"	\$4.60

Miniature Felt Wheels

Solid felt for use with mandrel. Wheels are sold by the box. 1/8" thick except Nos.171.380 and 171.381 are 1/4" thick.

Hard	Price	Box 100	Price	Soft	Price	Box 100	Price	Diam
171.351	\$4.20	171.352	\$16.05	171.355	\$3.60	171.356	\$10.05	1/2"
171.359	\$4.75	171.360	\$15.75	171.363	\$4.00	171.364	\$12.95	5/8"
171.365	\$5.90	171.366*	\$16.85	171.367	\$4.20	171.368	\$13.45	3/4"
171.371	\$5.85	171.372*	\$21.00	171.376	\$5.10	171.377*	\$18.40	1"
				171.380	\$7.75	171.381*	\$29.95	1"

Miniature Felt Wheel Assortment

Solid felt for use with mandrel. Contains 1/2", 5/8", and 3/4" diameter wheels in the soft grade. Sold by the box.

171.345	Box of 24	\$6.35
171.346*	Box of 100	\$18.15

Miniature Knife Edge Felt Buffs

Hard solid felt, with tapered edges for polishing joints and crevices. For use with mandrel. Sold by the box.

Box 24	Price	Box 100	Price	Diameter
171.478	\$24.00	171.479*	\$59.95	1/2"
171.483	\$18.65	171.484	\$59.95	5/8"

DIXCEL® Felt Buffs

The finest made, these buffs continue to be produced to exacting specifications. Selection of Dixcel assures you of uniformity in thickness, balance, concentricity, and outstanding performance. They remain the standard of quality with professional polishers of metal.

Diamond Hard Felt Laps

Exceptionally dense, chemically treated felt. Suitable for forming smooth, flat surfaces with sharp corners.

No.	Diameter	Thickness	Hole	Price
171.291	6"	1/4"	1/4"	\$37.80
171.292	6"	1/4"	1/2"	\$39.95

Spanish Felt Wheel Buffs

Suitable for all-purpose polishing and buffing. Pin hole centers.

Ex. Hard	Price	Diam	Thick	Medium	Price	Diam	Thick
171.450	\$16.95	3"	1/2"	171.452	\$12.60	3"	1/2"
171.455	\$19.25	4"	1/2"	171.457*	\$18.80	4"	1/2"
171.460*	\$31.50	5"	1/2"	171.462	\$17.95	5"	1/2"
171.465*	\$32.95	6"	1/2"	171.467*	\$24.95	6"	1/2"
Hard				Soft			
171.451	\$13.45	3"	1/2"	171.453	\$12.15	3"	1/2"
171.456	\$15.95	4"	1/2"	171.458*	\$16.40	4"	1/2"
171.461	\$19.95	5"	1/2"	171.463	\$15.95	5"	1/2"
171.466*	\$29.95	6"	1/2"	171.468*	\$21.95	6"	1/2"
171.470	\$69.75	6"	1"				

Solid Felt Wheel Buffs

Tightly compressed wool felt forms a medium wheel for all-purpose polishing and buffing. All have pin hole centers.

No.	Diam.	Thick.	Price	No.	Diam.	Thick.	Price
171.410	1"	1/4"	\$1.75	171.425	2 1/2"	1/2"	\$4.75
171.412*	1 1/4"	1/4"	\$2.10	171.429	3"	1/2"	\$7.35
171.415	1 1/2"	1/4"	\$2.45	171.431	3"	1"	\$16.30
171.416*	1 1/2"	3/8"	\$2.65	171.435	4"	1/2"	\$13.00
171.417*	1 1/2"	1/2"	\$3.20	171.436	4"	3/4"	\$16.10
171.419	2"	1/4"	\$3.20	171.437	4"	1"	\$26.05
171.420*	2"	3/8"	\$3.95	171.438*	5"	2"	\$65.00
171.421	2"	1/2"	\$4.50	171.439*	6"	1"	\$29.95

Felt Combination Buffs

Wheel buff and inside ring buff mounted on wood mandrel, drilled to fit tapered spindle. Outside and inside of rings can be polished without changing buff.

No.	Wheel	Wheel Edge	Ring	Price
171.340	2" x 1/2"	Square	3" x 9/16" - 3/4"	\$9.50
171.341	2" x 9/16"	Square	4" x 5/8" - 7/8"	\$10.50
171.342	2"	Knife	3" x 9/16" - 3/4"	\$11.90
171.343*	2"	Knife	4" x 5/8" - 7/8"	\$12.10

Solid Felt Ring Buffs

Unmounted solid felt is used directly on tapered spindle, or with shell spindle Nos. 471.280 and 471.281.

Extra Hard	Price	Regular	Price	Diameter	Length
171.333*	\$5.55	171.332	\$4.60	9/16"	3"
171.336*	\$6.05	171.335	\$5.60	5/8"	4"

Felt Inside Ring Buffs

Highest grade wool felt mounted to tapered wood mandrel, drilled for tapered spindle. Smallest is suitable for children's rings.

Extra Hard	Price	Regular	Price	Diameter	Length
171.316	\$5.10	171.315	\$4.85	5/16"-9/16"	3"
171.321*	\$5.60	171.320	\$4.95	9/16"-3/4"	3"
171.324	\$5.85	171.323	\$5.60	5/8"-7/8"	4"
171.327	\$7.20	171.326	\$7.25	11/16"-1"	5"
—	—	171.329	\$8.45	3/4"-11/16"	6"



Knife Edge Felt Wheels

Pin hole centers for mandrel in handpiece or on tapered spindle.

Rock Hard	Price	Hard	Price	Diameter
171.491	\$1.90	171.490	\$1.75	1"
171.493*	\$2.10	171.492	\$2.10	1 1/2"
171.495	\$3.25	171.494	\$3.10	2"
171.497	\$5.55	171.496*	\$5.60	2 1/2"
171.499*	\$5.80	171.498	\$5.80	3"
171.500	\$8.25	—	—	4"

DIXCEL® Miniature Wire Brushes

For cleaning, polishing and producing special finishes. Precision made, excellent quality. Use brass on yellow metals such as copper and brass, and steel on white metals such as aluminum. Straight or lightly crimped wire produces a more pronounced finish and is used for cleaning, deburring and surface finishing. Crimped wire achieves a softer or matte finish.



161.805 - 161.819

Brass Brushes on Mandrels

Double section type is for heavy-duty use. Sold by the dozen.

Type	Diam.	Arbor Diam.	Straight .0035"	Price	Crimped .005"	Price
Single section	3/4"	3/32"	161.805	\$22.25	161.806	\$17.65
Double section	3/4"	3/32"	—	—	161.807	\$26.50
Single section	3/4"	1/8"	—	—	161.810	\$23.25
Double section	3/4"	1/8"	—	—	161.811	\$31.25
Single section	1"	3/32"	161.813	\$22.95	161.814*	\$19.20
Double section	1"	3/32"	—	—	161.815*	\$24.50
Double section	1"	1/8"	—	—	161.819*	\$26.50

Steel Brushes on Mandrels

Double section type is for heavy duty use. Sold by the dozen.

Type	Diam.	Arbor Diam.	Light Crimped .003"	Price	Crimped .005"	Price
Single section	3/4"	3/32"	161.840	\$19.25	161.841	\$19.45
Double section	3/4"	3/32"	—	—	161.842	\$29.95
Single section	3/4"	1/8"	161.844	\$25.25	161.845*	\$26.05
Double section	3/4"	1/8"	—	—	161.846*	\$31.75
Single section	1"	3/32"	161.848	\$20.25	161.849*	\$21.05
Double section	1"	3/32"	—	—	161.850*	\$32.25
Single section	1"	1/8"	161.852*	\$25.50	161.853*	\$26.30
Double section	1"	1/8"	—	—	161.854*	\$35.00



161.840 - 161.854

Unmounted 3/32" Arbor Hole Wire Brushes

Available in single section only. Bristles are set in metal hubs that can be threaded on mandrels. Sold by the dozen.

Metal	Diam. at Flare	Straight .0035"	Price	Light Crimp .003"	Price	Crimped .005"	Price
Brass	3/4"	161.880*	\$17.95	—	—	161.881*	\$13.20
Brass	1"	161.883*	\$22.95	—	—	161.884	\$13.20
Steel	3/4"	—	—	161.886*	\$14.75	161.887*	\$15.30
Steel	1"	—	—	161.889	\$15.30	161.890	\$15.50



161.880 - 161.890

End-Type Wire Brushes on Mandrels

Sold by the dozen.

Metal	Diam.	Brush	Arbor Diam.	Straight .0035"	Price	LtCrimp .003"	Price	Crimped .005"	Price
Brass	3/16"	1/4"	3/32"	161.926	\$8.95	—	—	161.927*	\$9.75
Steel	3/16"	1/4"	3/32"	—	—	161.940*	\$11.50	161.941*	\$10.10
Steel	3/16"	1/4"	1/8"	—	—	161.943*	\$13.20	161.944*	\$13.50



161.926 - 161.944

Cas-Ker Miniature Bristle Wheel Brushes

Abbott-Robinson precision brushes are time-proven for quality and durability. Ideal for cleaning and polishing in hard-to-reach places. Single section 3/4" diameter, 3/32" Mandrels. By the dozen or 144.

160.600	Soft Grey	\$10.75 dz	\$97.50/144
160.609	Stiff Silver	\$10.25 dz	\$97.00/144



160.600

160.609

DIXCEL® Miniature Bristle Brushes

Excellent quality precision brushes for cleaning and polishing in hard to reach places.

End Brushes on Mandrels

Sold by the dozen.

Brush		Mandrel					
Diam.	Length	Diam.	Soft	Dozen	Stiff	Dozen	
3/16"	1/4"	3/32"	161.700	\$6.95	161.701	\$6.85	
3/16"	3/8"	3/32"	161.707	\$7.35	161.708	\$6.90	
3/16"	1/2"	3/32"	161.710	\$7.25	161.711	\$7.15	
3/16"	5/8"	3/32"	—	—	161.713	\$7.35	
1/4"	3/8"	3/32"	161.718*	\$15.35	—	—	
5/16"	5/8"	3/32"	—	—	161.714*	\$18.50	
5/16"	5/8"	1/8"	—	—	161.717*	\$19.95	



161.700 - 161.718

Wheel Brushes on Mandrels

Available in single section or heavy-duty double section style.

Sold by the dozen.

Section Brush Man.

Type	Dia.	Dia.	Ex-Soft	Dozen	Soft	Dozen	Stiff	Dozen
Single 9/16"	3/32"	161.601	\$12.20	161.603	\$11.95	161.602	\$11.95	
Single 3/4"	3/32"	161.608	\$11.95	161.607	\$11.40	161.609	\$11.50	
Double 3/4"	3/32"	161.612	\$18.95	161.611	\$17.35	161.613	\$18.70	
Single 3/4"	1/8"	—	—	161.616	\$16.05	161.615	\$15.75	
Double 3/4"	1/8"	—	—	161.618*	\$22.70	161.617	\$18.25	
Single 1"	3/32"	161.619*	\$12.20	161.620	\$11.95	161.621	\$12.10	
Double 1"	3/32"	—	—	161.624	\$19.20	161.623	\$17.75	



161.601 - 161.624

Dixel® Unmounted "BB" 1/8" Arbor Hole Brushes

More Bristle! 30% more fill gives more body, for the right feel and longer brush life. Thin profile metal hubs are assembled on specially designed production equipment. The result is a perfect brush where bristles won't split and washers won't spin. Available in 4 grades to perfectly match every production requirement. Sold by the dozen.

Brush

Diam.	Ex	Soft	Dozen	Soft	Price	Med.	Dozen	Stiff	Dozen
5/8"	—	—	161.647*	\$8.20	161.648*	\$7.25	161.649*	\$7.70	
3/4"	161.662	\$7.95	161.650	\$7.50	161.663	\$8.00	161.664	\$7.75	
1"	161.671	\$10.50	161.651	\$10.30	161.672	\$10.10	161.673	\$9.50	
1 1/4"	161.677*	\$11.55	161.652*	\$11.30	161.678	\$12.10	161.679*	\$11.30	

Use with mandrel 471.258 or 471.259, which fits on tapered spindles of polishing motors. See page 148.



161.662 - 161.679

Cup Brushes on Mandrels

Sold by the dozen.

Dia. at		Mandrel					
Flared End	Diameter	Soft	Dozen	Stiff	Dozen		
1/2"	3/32"	161.750*	\$18.75	161.751	\$19.80		
9/16"	3/32"	161.753*	\$20.50	161.755*	\$22.45		

Unmounted 3/32" Arbor Hole Brushes

Use stiff bristles for cleaning, soft for polishing. Sold by the dozen. Mount on mandrels sold on page 148.

Brush Diameter	Soft	Dozen	Stiff	Dozen
9/16"	161.657	\$8.70	161.658*	\$8.40
3/4"	161.660	\$8.25	161.661	\$8.40
1"	161.669	\$8.70	161.670*	\$7.95



161.750 - 161.755



161.657 - 161.670

DIXCEL® Wheel Brushes

For cleaning, polishing, and producing special finishes. Wood hub brushes are bored to fit on tapered spindles of polishing motors. *Custom designs available!*



Grobet® Jewelers Series G2000 Brushes

The ultimate brush designed specifically for jewelry applications. Trim and angle provide access to the most intricate designs. Premium quality Chungking bristle is specially selected for use on precious metals, giving superior results piece after piece. The seasoned hardwood hubs are precision bored for a perfect fit on tapered spindles.

No.	Style	Hub Diam.	Rows	Trim	Price
161.398	G2001A	1 ⁷ / ₈ "	1	5/8"	\$2.70
161.404*	G2001B	1 ⁷ / ₈ "	1	1/2"	\$2.45
161.399	G2001C	1 ⁷ / ₈ "	1	3/8"	\$2.30
161.396	G2002A	1 ⁷ / ₈ "	2	5/8"	\$3.85
161.403	G2002B	1 ⁷ / ₈ "	2	1/2"	\$2.95
161.397	G2002C	1 ⁷ / ₈ "	2	3/8"	\$2.45
161.383	G2006A	1 ¹ / ₄ "	2	5/8"	\$2.95
161.381*	G2006B	1 ¹ / ₄ "	2	1/2"	\$2.65
161.380	G2006C	1 ¹ / ₄ "	2	3/8"	\$2.75
161.384	G2007A	1 ¹ / ₄ "	3	5/8"	\$3.55
161.387*	G2007C	1 ¹ / ₄ "	3	3/8"	\$2.90
161.405*	G2008A	1 ¹ / ₄ "	4	5/8"	\$4.00
161.407*	G2008C	1 ¹ / ₄ "	4	3/8"	\$4.00

Black Bristle Wheel Brushes

Excellent quality, wedge-shaped, pure Chungking bristle is firmly secured into well-seasoned hardwood hubs for long-lasting service. Upright or Converging.

No.	Rows	Overall Diam.	Hub	Shape	Price
161.371	1	2"	1 ¹ / ₄ "	Upright	\$2.45
161.372	1	2 ¹ / ₂ "	1 ¹ / ₄ "	Upright	\$2.40
161.373	Discontinued - Use 161.399 at left				
161.374	1	3"	1 ⁵ / ₁₆ "	Upright	\$2.25
161.376*	2	1 ³ / ₄ "	7/8"	Converging	\$2.65
161.378	2	2"	7/8"	Converging	\$2.65
161.386	2	3"	1 ⁵ / ₈ "	Converging	\$3.00
161.388	2	3 ³ / ₈ "	2 ¹ / ₈ "	Converging	\$4.25
161.389	3	2 ¹ / ₂ "	1 ³ / ₈ "	Converging	\$3.80
161.390	3	3"	1 ⁵ / ₈ "	Converging	\$3.25
161.391	3	3 ¹ / ₂ "	1 ⁷ / ₈ "	Converging	\$4.25
161.393	4	3"	1 ¹ / ₂ "	Converging	\$4.00
161.394	4	3"	1 ⁵ / ₈ "	Upright	\$4.00
161.395	4	3 ¹ / ₂ "	1 ⁷ / ₈ "	Converging	\$4.50

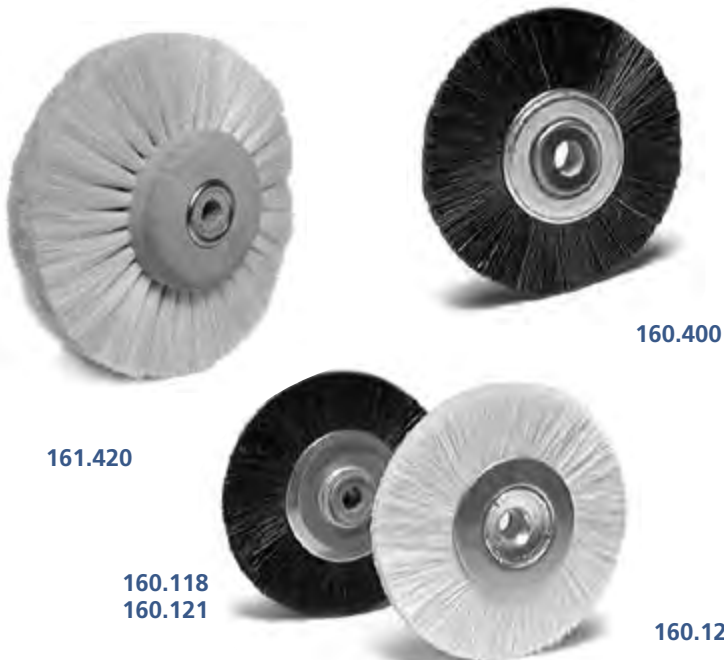

White Bristle Wheel Brush on Wood Hub

Mounted on hardwood hub with 1/4" straight hole. Four rows of soft bristles and overall diameter of 3".

161.420* \$8.50

Cas-Ker Bristle Brush

Black bristle medium stiff brush 1⁷/₈" diameter with steel hub and nylon center, 3/16" arbor hole.

160.400 \$3.25

Cas-Ker Natural Bristle Wheel Brushes

Natural bristle wheel brushes are 1⁷/₈" in diameter and have 1/4" holes. Stiff Black for cleaning, Soft White for polishing. Lead or plastic centers.

Number	Type	Each	Dozen
160.118	Stiff Lead	\$2.75	12 @ \$2.40 each
160.121	Stiff Plastic	\$2.75	12 @ \$2.40 each
160.120	Soft Lead	\$2.75	12 @ \$2.40 each

DIXCEL® Wheel Scratch Brushes

For cleaning and surface finishing on metal. Wire bristles are mounted on seasoned hardwood hubs with metal reinforced centers to fit tapered spindles. All have a 1/4" arbor hole.

Straight Brass Wire Brushes

For cleaning and surface finishing brass and other metals. Straight wire produces a coarser finish. Strands are .003".

No.	Rows	Diam.	Price	No.	Rows	Diam.	Price
161.425*	1	3"	\$8.35	161.430*	3	4"	\$20.75
161.426*	2	3"	\$13.65	161.431*	4	3"	\$24.75
161.427	2	4"	\$17.40	161.432	4	4"	\$27.60
161.429*	3	3"	\$21.85	161.433*	4	6"	\$42.90

Crimped Brass Wire Brushes

For surface finishing of yellow metals. Produces a softer, satin or matte finish. Strands are .004".

No.	Rows	Diam.	Price	No.	Rows	Diam.	Price
161.440*	2	3"	\$8.50	161.445*	4	3"	\$12.65
161.441*	2	4"	\$11.35	161.446*	4	4"	\$15.05
161.443	3	3"	\$10.70	161.447*	4	6"	\$22.65
161.444*	3	4"	\$14.20				

Lightly Crimped Steel Wire Brushes

For cleaning, deburring and surface finishing on silver, aluminum and other white metals. Pronounced surface effects. Strands .003".

No.	Rows	Diam.	Price	No.	Rows	Diam.	Price
161.455*	1	3"	\$10.25	161.460*	3	4"	\$17.25
161.457	2	4"	\$16.15	161.461	4	3"	\$14.55
161.458*	2	6"	\$18.15	161.462	4	4"	\$17.65
161.459	3	3"	\$10.50	161.463*	4	6"	\$25.80

Lightly Crimped Straight Steel Satin Finish Brush

Produces a frosted finish when run at high speeds. One row of .0055" steel wire bristles mounted on wood hub with reinforced metal center. Diameter 5".

161.472 \$18.20

Heavy Duty Crimped Steel Wire Brush

For removing rust, scale, grease, etc. from metal surfaces. Steel hub with flanges provides extra strength. 6" diameter .005" wire, with 1/2" arbor hole.

161.470* \$42.95

Steel Bur and File Cleaning Brush

Two rows of lightly crimped .003" steel wire removes particles of metal clogged between teeth of files and burs. Can also be used for stripping insulation from small electric wires. Diameter 1 5/8".

161.475 \$10.10

Scratch Brush with Nylon Bristles

Horotec brush has a non-roll plastic handle and replaceable nylon bristles. Twist the end to extend brush. 4 3/4" long. Germany.

160.341 Scratch Brush \$9.50

160.342 Refill Bristles \$2.10

Steel Scratch Brush for Cleaning Burs

Unique brushes are designed to provide fast and easy cleaning of burs. Wire is firmly bound in plastic tubing which serves as a handle and can be cut away to expose more wire. 3" long.

161.339 \$5.60



161.425* - 161.433*



161.440* - 161.447*



161.455* - 161.463*



161.472



161.470*



161.475



160.341

160.342

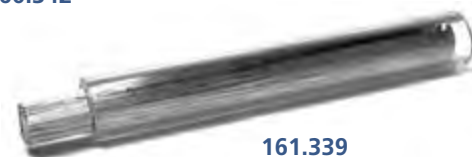

161.339



161.214



161.236



161.273



161.250



161.225



161.200



640.1300.6



160.000



640.7916

Vacuum Pen

Vacuum pen for handling small parts includes 3 soft rubber tips. Bergeon 7916. Swiss made.

640.7916 \$32.50

Flux Brushes with Quill Handles

Inexpensive, disposable brushes made of camel hair, mounted in hollow quill handles. For applying fluxes and other liquids.

No.	Length	Per Dozen	No.	Length	Per Dozen
161.219	1 1/2"	\$18.45	161.214	2 1/2"	\$18.90
161.218*	1 5/8"	\$18.45	161.213	3"	\$23.10
161.217	1 3/4"	\$18.45	161.212	3 1/2"	\$23.10
161.216	2"	\$18.45	161.211	3 3/4"	\$23.10
161.215*	2 1/4"	\$18.20			

Flux Brushes with Wood Handles

Well-constructed camel hair brushes are noted for durability.

Number	Size	Length	Dozen	Number	Size	Length	Dozen
161.231	#1	7"	\$25.55	161.234	#4	7 1/4"	\$33.65
161.233	#3	7"	\$32.05	161.235	#5	7 1/2"	\$45.70
				161.236	#6	7 1/2"	\$45.70

Red Sable & Synthetic Brushes

Pure red sable tips are hand cupped to shape and have needle sharp points. Round style. Securely mounted in aluminum seamless ferrules and attached to wood handles. Sold individually. Note: 161.273 is synthetic sable.

Number	Size	Each	Number	Size	Each
161.258	#3/0	\$3.35	161.263*	#3	\$5.75
161.259	#2/0	\$3.35	161.264*	#4	\$6.75
161.260*	#0	\$3.50	161.265*	#5	\$6.75
161.273	#1 Synthetic	\$2.25	161.266*	#6	\$8.95
161.262*	#2	\$4.50	161.267	#7	\$15.95

Mucilage/Acid Brushes

Extra stiff black horsehair with tin handle. Used in soldering applications and with acid.

161.250	3 1/4" long x 1/4" diameter	\$1.95
161.251	5 3/4" long x 3/8" diameter	\$2.30
161.252*	5 3/4" long x 1/2" diameter	\$4.00

Flux Brush with Tin Ferrule

Economical, disposable brush for applying fluxes, other liquids.

161.225 \$6.05 dozen

Camel Hair Brush

For all-purpose use. 7 1/2" with wood handle.

161.200 \$4.50

BERGEON Small Watch Brush

Soft natural brush with quill ferrule for dusting delicate watches and parts. 3 3/8" long.

640.1300.6 \$12.95

StaticWisk™ for effective dust and static removal

Kinetronics® Anti-Static Brush is made from a special blend of soft, natural hair and conductive fiber. The brush dissipates static charges and releases dust and debris. Effective for cleaning watch parts, lenses, microscopes, plastics, and more. 2" long . USA.

160.000 \$7.75

DIXCEL® BRUSHES

All Dixcel brushes have their bristles firmly anchored in their handles and are suitable for cleaning in and with solutions.

Dixel® Plastic Handle Washout Brushes

Available with natural or slightly stiffer nylon bristles. Overall length 7¹/₂" with bristles measuring 3" long and 1¹/₂" wide.

161.095	4 rows of natural bristles	\$7.95
161.097	3 rows of natural bristles	\$7.85
161.098	4 rows of nylon bristles	\$8.70

Dixel® Wood Handle Washout Brushes

Four rows of stiff natural bristles. Two sizes, both 8¹/₄" overall.

161.086	31 ¹ / ₂ " long, 3 ³ / ₄ " wide	\$5.90
161.087	21 ¹ / ₈ " long, 5 ⁵ / ₈ " wide	\$6.65

Dixel® Small Wood Handle Washout Brush

For cleaning inside confined areas. Overall length is 6" and the three rows of extra stiff bristles are 1⁷/₈" long and 3³/₈" high.

161.088		\$4.20
----------------	--	---------------

Dixel® Watch, Clock & Instrument Brushes

Bristles are available in varying degrees of hardness. Bristles measure 4¹/₂" long and 5⁵/₈" deep. Overall length 10¹/₄".

161.110	Hard - extra heavy grit	\$8.50
161.111	1/2-hard - general cleaning	\$9.05
161.112	1/2-soft - delicate parts	\$9.00
161.113	Soft - removing dust	\$9.75

Wood Handle Brush

For general cleaning and dusting. With 4 rows of medium-hard bristles 4¹/₂" in length. Overall length 10¹/₂".

161.0562		\$4.85
-----------------	--	---------------

Nylon Watch/Clock Brush

4 rows 1/2 Hard nylon bristles for general cleaning. Bristle portion is 4" long. Wood handle. 8³/₄".

160.114		\$2.25 ea 6@ \$1.75
----------------	--	----------------------------

Watch/Instrument Brush

Hardwood handled brush has 4" of 7⁷/₈" medium hard bristles for cleaning and dusting watches and fine instruments. 9" long overall.

160.155		\$6.50
----------------	--	---------------

Office Equipment Cleaning Brush

Has four rows of nylon bristles 1³/₄" long and 1¹/₂" wide. With angled lucite handle. Overall length 6³/₄".

161.099		\$2.65
----------------	--	---------------

Dixel® Bench Duster with Wood Handle

Four rows black bristles suitable for sweeping filings and general purpose work. Overall 9¹/₂" brush length 4", height 1³/₈".

161.051		\$6.95
----------------	--	---------------

Dixel® Hand/Fingernail Scrub Brush

Extra stiff white nylon bristles in a 3³/₄" x 1³/₄" block.

161.076		\$6.95
----------------	--	---------------

161.095
161.097
161.098



161.086



161.088



161.110 - 161.113



161.0562



160.114



160.155



161.099



161.051



161.076



SCRATCH & DUSTING BRUSHES



161.081



161.060



160.062



160.312

161.310
161.311
161.350*

161.334



160.625



160.293



160.294



161.340



161.305

**Twisted Wire Brushes**

Designed for tube and handpiece cleaning. Overall length 8³/₈". Extra stiff horsehair bristle portion is 3" long, 1/2" diameter.

161.080 Tapered (not shown) **\$2.95**

161.081 Straight **\$4.50**

Dixel® Dusting Brush

Soft camel hair brush with wood handle, for removing dust from delicate surfaces. Overall length 4¹/₄".

161.060 **\$4.50**

Soft Nylon Dial Brush

Plastic with nylon bristles for dusting dials. 4¹/₂" long, India.

160.062 **\$1.70 ea 3 @ \$1.50 ea 6 @ \$1.25 ea**

Brass Scratch Brush

Six rows of fine brass wire crimped in wood handle. Overall 8¹/₂".

160.312 **\$3.25**

Dixcel® Brass Scratch Brush with Plastic Handle

Four rows of .003" wire. Brush is 3¹/₄"L x 3/4"H. Length 7¹/₄".

161.311 **\$17.45**

Dixcel® Brass Scratch Brush with Wood Handle

Four rows of .003" wire. Brush is 4¹/₂"L x 3/4"H. Length 8¹/₄".

161.310 **\$8.50**

Dixcel® Steel Scratch Brush with Wood Handle

Four rows of lightly crimped .003" wire. Brush is 4¹/₂"L x 3/4"H. Overall 8¹/₄".

161.350* **\$9.65**

Glass Bristle Scratch Brush

Removes rust and dirt from metal surfaces. Fine glass bristles are bound in cord to unwind as they wear down. 7" x 1/2" diameter.

161.334 **\$15.55**

BERGEON Fiberglass Scratch Brush

Removes rust and dirt. Press button at end to open spring loaded jaws to release more fiber. Small tip. Bergeon 6240.

160.625 **\$14.95**

160.626 Refills **\$2.25 ea 3 @ \$1.75 ea 12 @ \$1.50 ea**

Brass or Fiberglass Scratch Brushes

Pen-shaped handles come in brass or fiberglass. Use for removing rust or corrosion in hard to reach places such as battery cavities. Durable metal ferrules. Quantity prices available for refills.

160.293 Brass **\$7.95**

160.294 Fiberglass **\$7.50**

160.295 Fiberglass Refills pack of 3 **\$3.95**

160.296 Brass Refills pack of 3 **\$3.95**

Dixcel® Steel Scratch Brush in Holder

Wood handle provides comfortable grip for bur cleaning. Has fine steel wire bound in plastic. Overall length 5".

161.340 **\$6.75**

Double-Sided Brass Scratch Brush

For cleaning work before soldering. Brass wire bristles are approximately 1³/₄" long and bound in metal holder. Germany.

161.305 **\$11.10**

New Tech Handy II for Quartz

For repair service, the watchmaker needs a test instrument with a simple way to perform all electrical measurements and tests on quartz watches. The compact, easy to use New Tech Handy measures rate, consumption, resistance values, lowest operating voltage and tests battery.

590.899 **CALL for a competitive quotation**



590.899

Analyzer Twin for Quartz and Mechanicals

Combined measurement and test instrument offers all the functions of both Watch Expert III and the Witschi's Quartz Analyzer Q1. Features mirrored test platform, hi-res color display and rotating microphone for mechanical watches.

590.879 **CALL for a competitive quotation**

590.955 Replacement Screw for Auto Microphone AMI **\$5.25**



590.879



550.103

590.873

Martel Compact Thermal Printer for Witschi Testers

Incorporating an "easy-load" printer mechanism this compact thermal printer has a secure locking paper reservoir lid and a simple, fast paper loading arrangement. Highly reliable printer features high print quality and high speed, plus it's quiet and maintenance-free. Features RS232 interface, cable included, to connect directly to the tester. Uses 58mm paper and measures 85.5 x 55 x 150mm. Operates on 4-AA batteries, also included. Manufactured in the UK by Martel.

550.103 Martel Printer **\$339.00**

610.203 Paper for Martel Printer **\$4.25 ea 5@ \$3.75 ea**

550.108 AC Power Cord Assembly for Martel Printer **\$62.95**

Watch Expert IV Mechanical Watch Tester

Test the rate accuracy, amplitude, and beat error of mechanical watches with the Watch Expert. Watchmakers trust the Witschi Watch Expert for precision measurements and functionality of multiple modes. New high-quality color touchscreen and new microphone for menu navigation.

590.897 **CALL for a competitive quotation**



590.897

Support & Dust Cover for Watch Expert III Microphone

590.873 **\$41.95**

 LEADING SWISS PRODUCTS



640.7803

Genuine BERGEON Automatic Watch Winders provide lifelike performance tests

Tests automatic winding mechanisms, winds automatic watches and checks mechanical parts on quartz watches, including calendar mechanisms. Foam holders and elastic fasteners secure watches with or without strap and will not mar cases. Use in horizontal or vertical position.

Bergeon 7802 Final Test Wrist Simulator

Lifelike performance test at 1 RPM for watches which wind in both directions. Swiss made.

640.7802

\$749.00

Bergeon 7803 Auto Test

Automatic Test for watches which wind in only one direction. 4 RPM. Swiss made.

640.7803

\$749.00

BERGEON



640.7802-SV

Bergeon Support for Automatic Watch Testers

Stand for Bergeon Final Tester 640.5802 & Auto Test Cyclotest 640.5803. May be mounted on a wall. Bergeon 7802-SV.

640.7802-SV

\$279.00



590.711



Witschi Teslascope Magnetic Detector/Demagnetizer

The first combined instrument for both magnetic field measurement and demagnetizing. The Teslascope offers user-friendly operation with easily interpreted results.

- Demagnetizes and detects the magnetic state of mechanical watches in a single step.
- Easily test watches with or without bracelet, movements and steel watch parts of small dimensions with a convenient, freestanding support.
- The magnetization degree is represented strengthen-dependently over several LED's.
- Swiss made.

590.711

CALL for a competitive quotation 1-800-487-0408

Thermal printer for new generation Witschi equipment.

Genuine Witschi printer, compatible with all new generation Witschi devices. Wireless communication possible with Chronoscope S1 (G2), X1 (G3) and Watch Expert. Automatic ticket cutter.

550.112

\$399.00



550.112

Watch Tester with Printer

The MTG-9900A timegrapher comes with a high definition LCD touchscreen with stylus pen, automatic microphone, and compact automatic heat sensitive printer. Tests both normal and co-axial watches; 8 frequencies of mechanical watches can be manually or automatically tested.

- Display daily rate of watch in seconds per day +/-300 s/d, accurate to +/-1 s/d.
- Beat error: 0-4ms, allowable tolerance +/-0.1ms.
- Amplitude: 90-350 degrees, allowable tolerance +/-3 degrees.

590.881

\$1195.00



590.881



Greiner vibrograf Swiss Equipment

Greiner Compact 900 Watch Tester

Universal watch timing instrument for both mechanical and quartz watches. Test results are displayed on a color LCD display, for easy operation and individual programming, 2 control LED's on the front panel for the indication of the watch signal.

- A serial interface RS232 for the connection of a printer or PC.
- A speaker is integrated for controlling beat noises of a watch.
- INCLUDES MP86M Mechanical Microphone.
- The Vibrograf Compact 900 can be operated either in automatic or in manual mode.
- The following values are measured and indicated: Mechanical watches: beat frequency, out of beat value, time deviation, amplitude, escapement noise (graphic). Quartz watches: out of beat value, current consumption, resistance of the motor coil.
- The results and diagrams are indicated on the display.

590.854 CALL for a competitive quotation 1-800-487-0408



590.854



MP 86M
Microphone for Mechanical Watches



QM 4
Combination Microphone for Mechanical, Quartz and Tuning Fork Watches

Mirror Support EM 06

Mirror Support Power Supply for quartz movements. Use with the Compact 900.

590.857 \$219.00



590.857

Magnetest II

Measures the magnetism of an object and displays the amount (strong, weak or not at all) by means of red lights.

260.000 \$519.00



260.000

Magnomatic Demagnetizer

Electronic demagnetizer uses alternating magnetic field of high frequency. Will not harm delicate parts.

260.101 CALL for a competitive quotation 1-800-487-0408

260.102 Replacement Lever Switch for Magnomatic \$39.95



260.101

CBM920 Printer

Citizen Printer with cable for printing out test results from the Poseidon Leak Tester and the Compact 900 Watch Tester.

550.102 Citizen Printer CBM 920 \$309.95

610.201 Paper for Citizen Printer 58mm (2 1/4") wide \$6.50

610.202 Black Ribbon for the Citizen Printer \$19.95



610.200



550.102

Watchmakers' B200 Timing Machine Paper

Paper for Vibrograf B200. Sold in individual rolls.

610.200 \$8.95

Cas-Ker is a USA distributor of Greiner Swiss made equipment. We will be glad to special order any Greiner products you require.



Greiner vibrograf



590.588

Horotec® FlashTest Multifunction Tester for Quartz Watches

This multifunction portable tester for analog quartz watches and movements is supplied with two precision probes, 9V adapter, 9V alkaline battery, instructions for use, technical guide (movement consumption and coil resistance values of popular quartz movements). Large LCD display gives quick and easy readings. Swiss made. FlashTest has capabilities to perform:

Quick Tests Without Opening the Watch

- Electronics (battery, circuit, coil, step motor).
- Mechanical Parts (by unjamming wheel train, hands and calendar parts).

Use these tests when a watch is New (before sale), Repaired (before returning to customer) or Damaged (for a quotation before a repair).

Accurate Tests By Opening the Watch

- Real battery status.
- Consumption of electronic circuit and of movement.
- Coil continuity.

Tests performed with opened watch are necessary to get precise information on real status of vital components.

590.588

\$399.95



590.843

590.844

Horotec® TURBO tests quartz wheel trains

The Turbo tests the mechanical side of a quartz analog watch movement. This battery operated tester provides powered magnetic impulsion for turning the wheel train and watch hands of most quartz analogs. Turbo can be used for unjamming the wheel train (jammed from dust, dry oil or hands), or for testing the wheel train functioning after testing the electronic side with the Horotec Pulse. Uses a 9V battery, included. Swiss.

590.843

\$79.95

Horotec® PULSE tests coils and circuits

Tests the electronic side of a quartz analog watch movement. Battery operated tester intercepts impulsion coming from the coil of a movement. When a signal is picked up, a yellow diode lights up and Pulse makes an audible beep. If Pulse intercepts the impulsion of a watch and the hands do not turn, that means the electronic side is functioning well and the defect is in the mechanical side. Powered by a 9-volt battery, included. Swiss.

590.844

\$72.95



590.859

Multifunction Timegrapher meters Rate, Beat, AND Amplitude of Mechanical Watches

As Required by High End Watch Manufacturers

The Timegrapher tests the performance of mechanical watches. When programmed testing is applied, the numerical values for rate, amplitude and beat error in all positions can be displayed at the same time, and the maximum differences of rate and amplitude in different positions are also displayed.

- LCD Digital Display of Rate, Beat Error and Amplitude in both Numbers and Graph Diagram.
- Four different display modes as well as multi-rate display, diagram shift, simulation of beat noise and "pause" functions.
- Tests Watches with Beat Numbers from 18000 to 36000.
- Automatic or Manual Beat Selection.
- Diagrams and parameters can be printed to a thermal printer.

590.859

\$995.00

The Timegrapher features a larger screen, making it more user-friendly than the leading brands.

Seiko Kinetic Energy Supplier recharges all types of kinetic watches

This instrument recharges the capacitors of Seiko Kinetic watches. Place watch on the instrument face down and position for optimal charging according to the model of watch. Positions are indicated by a color chart on top of the instrument.

- Charge without removing watchband.
- Charges all types of Kinetic models.
- Suitable for voltages from 110V to 240V.
- With AC adapter and power cords.

810.245

\$219.95



810.245

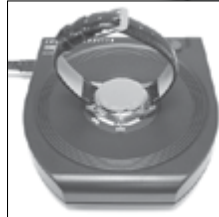

Renata Watch and Battery Tester

Tests for analog quartz mechanical defects and battery voltage.

Watch Test checks before opening a watch, if it requires a battery change or a repair. **Battery Test** for high and low drain Silver Oxide, Mercury, Alkaline, and 3 Volt Lithium "CR" and "BR" batteries. Powered by a CR2430 Lithium battery. Swiss.

590.305

\$52.50



590.305

Battery Pulse and Coil Tester

- Tests the full range of Silver, Mercury, and Coin Lithium cells.
- Tests basic watch pulse by placing watch face down on tester.
- Audio pulse indicates magnetic signal from coil.
- Two probes for individually analyzing coil continuity and battery charge.

- Made of sturdy molded plastic.
- Uses one 9Volt battery, included.
- Spring clip contact for loose cells.
- Testing instructions on bottom of tester.

340.345

\$43.95



340.345

Quartz Watch Impulse Button Battery Checker

Wrap a quartz watch around this impulse and battery checker to easily identify defective parts. No need to remove the case back to determine if the problem is the battery, electrical parts, or mechanical parts of a quartz watch.

340.401

\$29.95



340.401

Capacitor Charger

Swiss made quick charging apparatus for MT 1.5 V capacitors..

590.889

\$89.95



590.889

BATTERY GUIDE

Use the appropriate battery for the type of watch.

BATTERY	WATCH TYPE
1.6 volt Silver Oxide	Quartz Analog
3.0 volt Lithium	Quartz Digital
1.5 volt Alkaline 1.6 volt Silver Oxide	Analog - Digital



340.346

Test all types of batteries easily

Simple, easy to use tester for regular button cells, lithium and nickel cadmium batteries, as well as D, AA, AAA, 9V & photo cells.

340.346

\$10.95

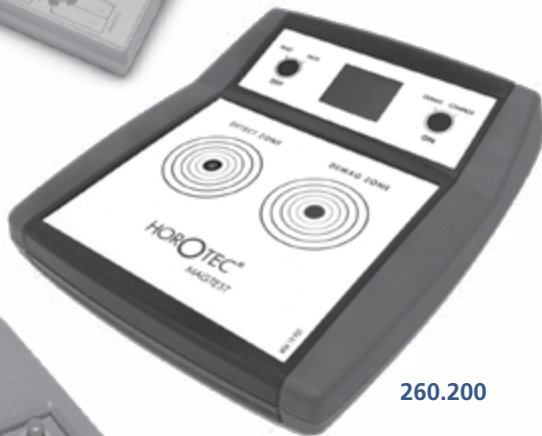

260.200

Horotec Magtest

Detects and eliminates magnetism in watches, watch parts, movements and tools.

- LCD screen shows the location and force of magnetism electronically read by five sensors.
- Can also be used as a compass
- Swiss made by Horotec

260.200

\$479.00



260.705

Compact Demagnetizer

This powerful and compact demagnetizer is highly efficient and suitable for all mains voltages. Equipped with a pilot light.

260.705

\$63.95



261.0415A

Demagnetizer

Simple, conventional style model. Wire coils are insulated to prevent shorting and overheating. There are no exposed wires and the unit operates in any position.

261.0415A

\$328.00



260.704

K&D Large Demagnetizer

Demagnetizes or magnetizes parts, tools and meters. To demagnetize, simply hold object in the center of the opening with button depressed for 3 or 4 seconds. To magnetize, hold the part or tool against the inside of the opening and press the button for 4 or 5 seconds and release. Opening is 3" x 1 1/2", large enough for cassette tapes for quick erasure. Six month warranty.

260.704

\$73.75



641.2321

Genuine BERGEON Demagnetizer

Tweezers, screwdrivers and steel rulers can be instantaneously and completely demagnetized over their entire length by simply placing them in the 2 1/2" diameter tunnel and pressing the button. Stronger than conventional demagnetizers and current can be left on continuously with no damaging effects. No moving parts to wear and will not burn out. Bergeon 2321-115/230

641.2321

\$319.95

Poseidon LT 100 Waterproof Tester

The intelligent leak tester with color display for easy operation and clear indication of the result.

- Automatic measurement with vacuum and pressure (-0.7 Bar to 10 Bar).
- 12 test programs also individually programmable.
- Serial interface for printer (such as Citizen CBM920) or PC.
- Requires tank or pump compressor - see the Gast Compressor.

550.100 Poseidon LT 100 Waterproof Tester

CALL for a competitive quotation 1-800-487-0408

550.107 Replacement Power Cord for Poseidon Tester **\$31.50**

550.106 Fuse for Poseidon Tester 10AF/230V **\$7.50**

Maintenance Kit 550.109 cleans valves and is **required** to validate Greiner Vibrograf warranty on the Poseidon LT-100.

550.109 Maintenance Kit for Poseidon Tester **\$349.95**

550.101



Gast Compressor

Use with Waterproof Testers for testing up to 10 bar.

550.101 Compressor **\$675.00**

550.104 Felt Filter Material **\$4.50**

Lititz Wet Pressure Watch Tester

This rugged instrument tests watch pressure up to 125 Bar. The unit is professionally designed and manufactured to the highest standards. Uses distilled water.

- Maximum pressure 125 BAR/125 ATM.
- Dimensions: 8"H x 11"W x 4"D.
- 2.5" diameter chamber, 2" depth.
- Made in USA.

550.000 **\$3295.00**

Thermo Scientific Cimarec™ Hot Plate

Cimarec™ digital hot plate offers precise temperature stability and safety for all your parts heating applications. Often used for water resistance tests in the watch industry so that Rolex and other watch manufacturers know the testing temperature. The hot plate delivers a host of capabilities for all parts and liquid heating needs. Ideal for shops that require precise temperature stability with digital control for repetitive sample procedures.

- Temp. Range: 5° to 540°C in 5°C increments (41° to 1004°F).
- Easy-to-read digital display and HOT SURFACE warning alerts.
- Microprocessor controls with feedback technology maintain consistent repeatable temperature settings.
- Flat top and high-wattage heating elements combine to provide superior heat transfer and fast heat-up.
- Ceramic top heats to higher temperatures than aluminum tops and it is easy to clean.
- Dimensions: 3.6"H x 5"W x 10"D. Heat Surface: 4.25" x 4.25".
- Weight: 7 lbs. Three Year Warranty.

590.060 **\$319.00**

550.100

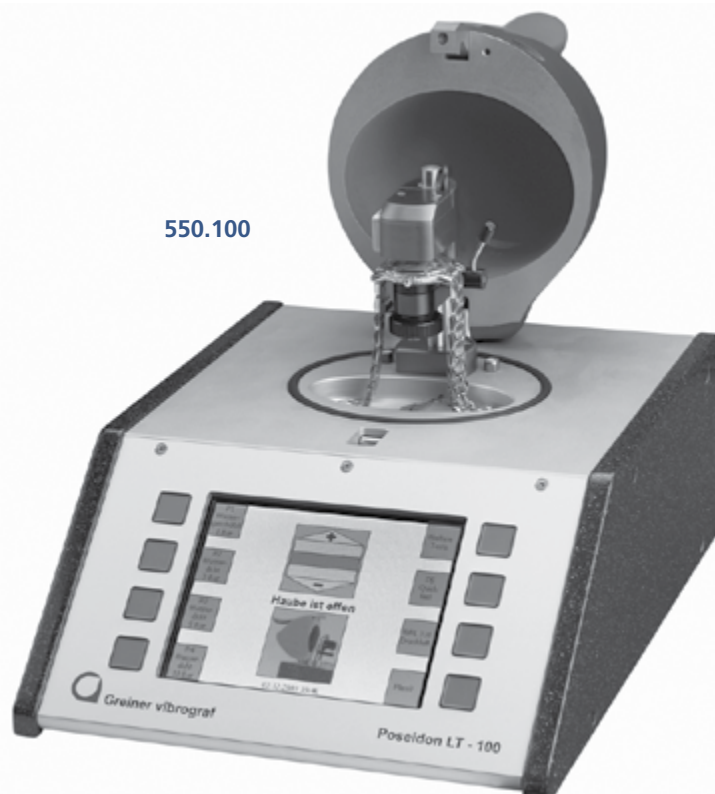

550.000

Made in USA



Cimarec Hot Plate offers Simplicity, Safety & Value.

590.060

BERGEON

BERGEON 10 Bar Wet Test Waterproof Tester

The latest Wet Tester from Bergeon tests the water resistance of watch cases up to 10 bar (ATM).

- Air pressure system tests from 0 to 10 ATM.
- Connector for compressor or pump (requires optional connector kit 5555/10-R, Special Order \$299.00).
- Removable plexiglas cylinder for draining.
- Dimensions: 390x153x245mm including handle.
- Cylinder: 70mm diameter.
- Very stable cast aluminum base.
- Capacity: two watches.
- Made in Switzerland.

640.5555

\$1199.00



Genuine BERGEON Waterproof Tester

Plexiglas cylinder is designed not to crack while tightening the knurled hatch knobs. Cylinder base is beveled and has additional O-ring gaskets to provide an airtight enclosure. And it's easy to dismantle for cleaning the hatch, cylinder and base.

Test watches under normal conditions of wear without inducing water into the case. On the counter, the Bergeon tester enables you to give the customer a quick and convincing demonstration of the water resistance of a watch. In the workshop, this easy to use apparatus will be at hand whenever the watchmaker needs to check the water resistance of a watch case. Capacity: two watches.

- Air pressure system. Tests up to 3ATM, safe to 6ATM (200 ft).
- Plexiglas cylinder with double seals.
- Dimensions: 245 x 150 x 310mm. Opening diameter: 64mm.
- Stable cast metal base.

550.555/98 Bergeon 5555/98 Waterproof Tester **\$729.95**

550.555/98-TP Chamber only for 5555/98 New Style **\$89.95**

550.556 Complete Gasket Set **\$34.75**

550.5555-TC Rod with Hook **\$28.75**

550.555/98.CV Complete Cover and Rod **\$109.95**



550.555/98



590.555TK



550.555/98.CV

Upgrade Kit for old style Bergeon Waterproof Tester. Complete Plexiglas Cylinder unit with additional O-Ring Gaskets.

590.555TK

\$239.00

Bergeon Essentials Catalog

Over 500 pages of Swiss watch tools and supplies. We stock many Bergeon products and we can special order all others for you.

640.BERG

\$5.50

Witschi Proofmaster S Leak Tester

The Witschi Proofmaster S Leak Tester is a refined, user-friendly instrument for seal integrity testing with pressure and/or vacuum from -0.80 to +10 bar. Versatile function set with eight pre-programmed and ten freely programmable test cycles. Automatic test cycle with one or two pressures, respectively with vacuum and pressure. Leak Finder Program for localization of watch leakages in water. RS232 interface to connect to a printer and USB interface for PC attachment. Requires a compressor with tank.

590.709 CALL for a competitive quotation 1-800-487-0408

550.003 Fuse for Witschi Waterproof Tester **\$10.50**



590.709

Panther Compressor

The Panther Silent Compressor is modified for 12 bar pressure required for 10 bar testing. Noise level is only 40dB (as quiet as a refrigerator). Included with the panther is a 0.93 gallon tank, line regulator with pressure gauge, 5 micron moisture filter and female quick coupler.

550.025 CALL for a competitive quotation 1-800-487-0408

550.110 Panther Air Intake Filter ext-fit **\$27.50**

550.111 Panther Filter Kit N Moisture Trap **\$38.75**



550.025



550.014

550.008

550.015

Nylon Tubing, Union Tee Fitting & Connector for Compressors

Operate two waterproof testers with one compressor using this 6mm O.D. tubing and push-to-connect fitting.

550.014 Tubing **\$3.50/ft.**

550.015 Tee Fitting **\$11.95**

550.008 Connector **\$20.00**

Witschi ChronoProof Pro® Water Resistance Tester

The compact ChronoProof Pro with integrated compressor turns you into a specialist able to reliably seal-test all types of wristwatches in no time at all. No programming necessary - just insert the watch, close the test chamber and the rest takes place automatically.

Complete with built-in Printer!

Integrated printer gives you the test result in black and white. You'll find space for this compact unit on every workbench and it looks just as good on any sales desk.

- Reliable results thanks to high-precision Witschi technology, offering measurement resolution of 0.02 μm - that's 1/5000 of the thickness of an average human hair.
- Easy user guidance on an interactive touchscreen.
- Vacuum: -0.3 bar. Pressure: 3 bar.
- Interface: USB 2.0
- 155W x 220H x 300Dmm.

550.451 CALL for a competitive quotation 1-800-487-0408



550.451

BERGEON



BERGEON Ultimate Tool Kit for after-sale watch service

This genuine Bergeon 6817 Kit features 42 specialized tools and accessories all in one convenient package. Included are tools for band adjustment, hand removal, battery replacement, cleaning, and more. Complete with a handsome well-made leather case. Swiss made.

- Tweezers & Screwdrivers.
- Hand Levers & Hand Setting Tools.
- Cutting Broaches & Spring Bar Tool.
- Case Opener & Presto Tools.
- Rodico Premium & Microfiber Cloth.
- Oiler Set & Moebius Oil.
- Movement Holder & Casing Cushion.
- Loupes and More!

640.6817

\$939.95

640.6817



BERGEON

640.7812



BERGEON Tool Kit for Quick Watch Service

Essential tools for the changing batteries and adjusting and replacing all types of bracelets. Contains 18 specialized tools and accessories in a handy case. Bergeon 7812.

640.7812

\$239.95

CasKer Complete Watchmaker's Setup

Our Complete Setup includes:

Number	Item	Value
120.226	UV Glue	\$6.50
130.371	Workmat	\$11.50
130.900	UV Lamp	\$39.95
230.150	CleanJet 2000	\$11.50
230.555	4x4 Watch Tissue	\$4.95
350.998	Digital Gauge	\$43.95
420.104	Speed Lubricator	\$9.95
580.300	Pin Vise	\$4.25
590.017	Link Tool	\$32.95
590.089	Case Holder	\$6.25
590.201	Bench Vise	\$6.50
590.293	Crystal Gauge	\$4.50
590.310	Hand Remover	\$46.75
900.046	Master Stem Asst	\$59.95
900.084	Clasp Spring Bar Asst	\$15.95
900.085	Spring Bar Asst 1.3mm	\$24.95
900.086	Spring Bar Asst 1.5mm	\$24.95
900.090	DP Crown Asst	\$47.95
900.091	WP Crown Asst	\$89.95
900.096	Bracelet Link Asst	\$23.95
900.098	Seiko Crown Asst	\$42.95
900.100	Mineral Crystal Asst	\$69.95
900.133	O-Ring Gasket Asst	\$54.95
900.144	Spring Bar Asst 1.8mm	\$25.95
900.200	Spring Bar Asst 1.3mm	\$24.95
Total Value		\$735.90
130.800 Complete Setup		\$659.00



Complete Tool Kit with Swiss Horotec Case Press

Ideal for shows, classes and more. Tools stay safe and neatly organized in the specially fitted sturdy case. Kit assembled in Switzerland and includes:

- Horotec Case Press with Nylon Dies.
- Bracelet Pin Remover.
- Pin Pusher / Spring Bar Tool.
- Victorinox Folding Pocket Knife / Case Opener.
- Pocket Size Screwback Case Wrench.
- Four Straight Screwdrivers with Spare Blades.
- Four Phillips Screwdrivers.
- Precetec Flat Nose Pliers.
- Battery Tester.
- Plastic Battery Tweezers.
- #1 Anti-Magnetic Tweezers.
- Watchmaker's Loupe.
- Wire Loupe Holder.
- Seiko Silicon Grease.
- Polishing Cloth.
- Fitted Case with Lock and Key.

590.610 **\$304.50**



590.610





810.227

Cas-Ker Battery Changing Kit

Here are all the basic tools for anyone to start changing watch batteries in a handy kit. The Cas-Ker Kit includes:

590.090	Screwback Opener	\$16.50
590.818	Case Opener/Gucci	\$15.95
590.795	Case Press w/Dies	\$39.75
590.047	Case Knife	\$6.95
340.346	Battery Tester	\$10.95
460.406	Chain Nose Pliers	\$7.75
590.012	Spring Bar Tool	\$4.25
520.500	7 piece Screwdriver Set	\$11.95
521.571	Phillips Screwdriver	\$7.40
571.958	Plastic Tweezers	\$3.20
Total Kit Value		\$124.45
810.227	Complete Kit	\$109.95

Basic Tool Set for changing batteries and more

Ideal for replacing batteries, this handy six piece set includes:

- Case Opener for screw back watches.
- Case Knife for snap back cases.
- Standard Screwdriver 1.00mm.
- Phillips Screwdriver 1.50mm.
- Plastic Tweezers for watch batteries.
- Non-magnetic Stainless Steel Tweezers.
- Vinyl Roll-up Carrying Pouch.

590.003 **\$27.50**



590.003

Basic Battery Changing Kit

This kit makes changing any watch battery quick and easy. Contains the following:

- 520.543/1.00 Flat Screwdriver 1.00mm
- 520.516 Phillips Screwdriver
- 571.958 Plastic Tweezers
- 590.255 Pocket Case Opener
- 460.406 Chain Nose Pliers
- 590.047 Flat Blade Case Knife
- 590.012 Spring Bar Tool
- 160.294 Fiberglass Brush

591.0285 **\$47.50**



591.0285

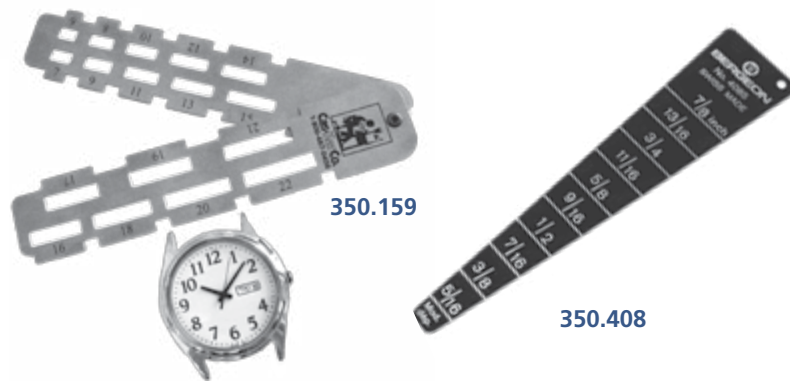

350.159

350.408

Stainless Lug Gauge

A simple, easy to use stainless steel tool for measuring watch lug widths 6mm to 22mm. Includes slots for measuring band ends.

350.159 **\$14.25**

BERGEON Lug Gauge

Measure between lugs in millimeters and inches. Bergeon 4085.

350.408 **\$17.25**

Cas-Ker Bracelet & Strap Repair Kit

Our portable kit includes all you need to repair and resize watchstraps and bracelets:

350.159 Lug Gauge.	590.118 Band Tool.
370.534 Hammer.	590.675 Bracelet Holder.
460.136 Expansion Pliers.	900.066 Buckle Asst.
460.404 Round Nose Pliers.	900.144 Spring Bar Asst.
460.816 Notching Tool.	Polishing Cloth.
460.999 Hole Punch Tool.	Tool Box with tray and
520.500 Screwdriver Set.	compartments in lid.
590.012 Spring Bar Tool.	
380.999	\$139.95



380.999

Cas-Ker offers the WBHQ® full line of quality watchstraps and bands - from sport styles to dress bracelets. Call for a copy of our WBHQ® Catalog and let us be your WatchBand Headquarters.

Cas-Ker carries thousands of quality horological tools and supplies! New products are constantly being added - if you don't see what you're looking for in our catalog, visit our website to see our newest items! www.casker.com

Here is a handy mini-index to some of the more popular watchmaking tools you'll find in this catalog >>>

- Case Openers pages 76-89
- Crystal & Bezel Tools pages 85-86, 93-95
- Hand Tools pages 96-100
- Quartz Repair page 108
- Spring Bar & Pin Tools pages 109-110
- Bracelet & Strap Tools pages 111-117
- Screwdrivers pages 173-179
- Tweezers pages 180-186
- Watch Oilers pages 252-256
- Eyeloupes pages 315-320

See our complete alphabetical index at the back of this catalog.

Battery Changing Kit in Case

Nine piece kit includes all the basic tools you need for changing batteries: Fiberglass Brush, 3 Flat Screwdrivers, Plastic Tweezers, Spring Bar Tool, Flat Blade Case Opener, Pocket Screw-back Case Opener, Polishing Cloth and a handy soft padded zippered Carrying Case.

810.000 **\$11.95**



Energizer

Watch Batteries

page 437



810.000

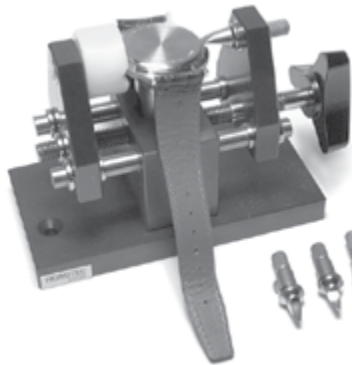

590.925



590.832



590.264



590.265



590.262



590.261

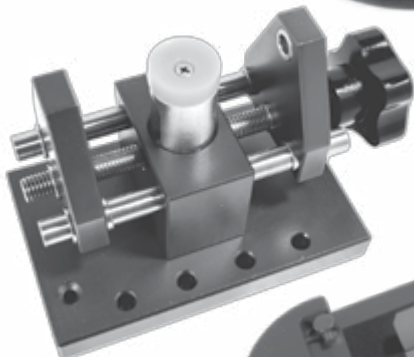

590.885

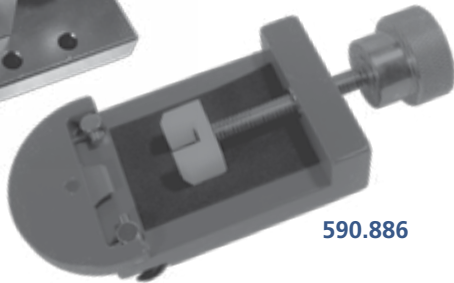

590.886



591.0620



590.408



590.409

Horotec Pressure Back Case Opener

Swiss made case opener/bezel remover lets you pry open pressure backs easily without marring watches. Opens to 60mm. Includes four pry tools.

590.925	Case Opener	\$389.00
590.925.1	Spare Blade Small 2.0mm	\$27.95
590.925.2	Spare Blade Large 4.0mm	\$27.95
590.925.3	Nylon Die	\$20.00
590.925.4	Spare Pin	\$1.95

Opener gives you new leverage on snap-back cases

This is a unique design for a case opener. Simply turn the large knob to tighten the case until the sharp blade is firmly in position, lift the lever to pop open the case back. Adjusts for different size cases. Hard plastic base and vise will not mar cases. Rubber feet keep it planted on the bench. Reversible blade is also replaceable.

590.832	Case Opener	\$34.50
590.832B	Replacement Blade	\$8.75

SEIKO Easy-Snap Case Opener and Vise

The Seiko tool is an opener and vise combined, making it easy to open all kinds of snap cases by any watch manufacturer.

Posts, caps and a rotating vise allow you to open a case without removing bracelet. User-friendly and lightweight. 6" x 5" x 4".

590.261	Seiko Case Opener	\$103.95
590.262	Replacement Pry Pins	\$9.95 pr
590.264	Replacement Vise Posts	\$6.50 pr
590.265	Replacement Vise Posts with Nylon Caps	\$11.95 pr

Swiss Style Jumbo Case Crab Opener

This tool lets you pry open pressure backs easily without marring watches. Fits up to 70mm watches.

590.885		\$115.00
----------------	--	-----------------

Swiss Style Snap Back Case Opener

Remove snap-on case backs with ease. Align the watch case with the blade and apply slight pressure to pop the watch back off. For watches up to 55mm.

590.886		\$79.95
----------------	--	----------------

Screw Back Case Opener

Provides a tight, non-slip grip. Long handle for increased pressure. Includes double blade.

591.0620		\$3.95
-----------------	--	---------------

Case Opener with Rounded Tips

Features rounded pin ends to fit jumbo sized watches.

590.408		\$11.95
----------------	--	----------------

Case Opener with Rectangular Tips

Features rectangular pin ends to fit jumbo sized watches.

590.409		\$11.95
----------------	--	----------------

WENGER Swiss Pocket Case Knife

By the maker of the famous Swiss Army Knife. 3³/₈" closed, very sharp stainless steel blade, case blade and black plastic handle.

590.883 **\$22.50**

White Pocket Case Knife by Horotec

Swiss made pocket knife features a 2" stainless steel blade and a watch case back opening blade in a white handle. 3³/₈" closed.

590.967 **\$14.95**

BERGEON 6403 Pocket Case Knife

Swiss made Wenger knife features a very sharp 2" stainless steel blade and a case blade. Black, 3³/₈" closed.

640.6403 **\$29.95**

Swiss Style Pry-Type Case Opener

Use minimal effort with this pry-type case opener which uses leverage to open watch backs.

590.410 **\$11.95**

Swiss Style 2-Lever Case Opener

This high quality and budget friendly case opener has two levers for opening most pressure and snap case backs.

590.411 **\$11.95**

Swiss Style Aluminum Ergonomic Case Knife

A heavy duty blade style opener. The ergonomic handle allows for tight and secure grip when opening tough cases.

590.412 **\$21.95**

Hammer Action Case Opener

The original Swiss opener with spring hammer action for the toughest snap-on case backs and for removing friction-fit case bezels. Adjustable striking force. May be used without punch action. Comfortable, ergonomic, with two hardened steel mirror finish blades, 3.0 and 4.5mm, and a pointed tip for bracelet links.

590.095 Opener w/3 Tips **\$207.95**

590.095.3 Tip for Bracelet Pins **\$19.95**

Spring-loaded Precision Case Opener

This is an exceptional precision opener for pressure back watch cases. Spring action provides extra pressure on stubborn cases. Includes three different shaped tips for an exact fit to caseback. Aluminum handle. Swiss made.

590.649 **\$89.95**

Snappy Case Opener

Just position the point between the case back and the case and push slowly. The blade "pops" under the back, making it easy to lift off. Instructions included.

590.195 **\$11.95**

Case Opener for Gucci

Exclusive Cas-Ker Opener made specifically to pry open many Gucci watches with notched backs. Case hardened steel - no more broken tweezers or damaged cases. Made in USA.

590.818 **\$15.95**

Cas-Ker is independent of and not affiliated with or sponsored by Gucci Timepieces.





590.045

Bench Knife

Deluxe bench knife features riveted handle and tempered blade. Excellent for opening watch cases. 5¼".

590.045

\$3.70



590.850

Opener for Swatch Battery Covers

Made specifically for Swatch battery covers. Hardwood handle.

590.850

\$6.50



590.420

Case Knife

Watch case opener with large easy-grip plastic handle.

590.420

\$12.95



590.283

Case Opener for Citizen

Opens Citizen snap type watch cases. Comfortable handle.

590.283

\$13.75



590.046

Push Type Case Opener

For snap type cases. Plastic handle fits comfortably in palm.

590.046

\$5.50



590.018

590.056

Universal Case Wrench

Opens most waterproof cases up to 41mm. Stainless steel. One side is for notched backs, the other for octagon types. Easily adjusted. India.

590.056

\$10.50

V-Shape Opener for Screwbacks

Sturdy opener for screwbacks is popular with many watchmakers, offering a heavy cast handle with a large surface for grasping. The claws adjust for different size backs, and a locking screw holds the claws securely in position. Pins fit polygon or notched case backs.

590.018

\$32.95



590.774

Suction Set With 8 Dies

Upper dies in aluminum fittings with synthetic rubber rings for opening screw back watch cases. Fits most bench top case presses. Comes with handle. Dies create a suction grip and with a quick turn of the press, cases open easily. Includes sizes 16mm, 20mm, 23mm, 26mm, 30mm, 34mm, 40mm, 65mm.

590.774

\$172.00



590.255

590.258

Swiss Pocket Case Opener

Tough and simple tool for opening most screw back watch cases. Central knurled screw for precise adjustment from 11 to 52mm (inside of pins). Swiss made.

590.258

\$15.95

Pocket Case Wrench

This wrench has tempered pins for easy use on waterproof cases. Knurled nut opens pins up to 53mm. 2 1/2" long. India.

590.255

\$5.50

Swiss Case Opener won't mar high grade watches

Swiss made tool is ideal for opening all high grade watches with snap back cases. Built-in nylon cylinder provides a rolling pressure point that won't mar valuable watch cases.

590.871 **\$115.00**

BERGEON Pry-Type Case Opener

For lifting backs of 3-piece cases. 5mm wide, 4¹/₄" long. Swiss.

590.475 **\$32.95**

Scoop Style Case Opener

An original ETIC Swiss made tool with hollowed-out cylindrical blade in hardened steel. Use a rolling motion to pry open snap-back watch cases. 5³/₈" long.

590.954 **\$25.75**

Case Opener for Pressure Backs

This knife features a blade on the side for opening friction-fit watch cases. Simply give the handle a twist and the case back will easily open. Total length 5³/₄".

590.807 **\$7.95**

BERGEON 2-Lever Case Opener

For pressure back waterproof and snap back cases. Side and end lever action for maximum effectiveness. Plastic lever cover prevents marring of watch cases. Swiss made #6484.

590.648 **\$52.50**

BERGEON Ultimate Case Knife

7/8" diameter and knurled texture gives you a better grip than other case knives. Anodized aluminum handle with a stainless steel blade firmly set with screws. 5³/₈" long. Swiss made #6987.

640.6987 **\$73.50**

640.6987L Replacement Blade only **\$10.50**

Horotec Case Opener for Pressure Back Watches

Large aluminum handle with knurled grip gives you more control and leverage when prying case backs. 5¹/₂" overall. Blade firmly held by screws and is replaceable using included allen wrench.

590.956 **\$59.95**

BERGEON Case Knife

Polished blades, overall length 4³/₈". Swiss made #4932.

641.4932 **\$28.25**

Stainless Steel Case Knife

Solid stainless steel will give you firm leverage on snap-back cases. 4¹/₂" long.

590.019 **\$6.50**

Blade Style Opener

For opening friction fit cases. Well tempered steel blade set in hardwood non-roll handle. Overall length 4³/₈".

590.047 **\$6.95**

Blade Case Opener

Polished and tempered steel blade with knife edges. Hardwood handle. 4¹/₂" long.

591.0625 **\$4.00**



BERGEON



591.050



590.099



590.948



590.055



590.806

Genuine BERGEON JAXA Wrench

The ergonomic shape provides a firm and comfortable grip. Opens almost all types of waterproof cases with diameters from 18mm to 62mm. Four sets of pins are easily removed and replaced. Precision tool has a heavy duty plastic body made for hard use. Includes a millimeter rule for measuring cases. Swiss made.

591.050	Bergeon 2819-08 Case Wrench with Pins	\$179.95
591.051	Bergeon 2819-C Set/3 Pins for Cases with Holes	\$13.50
591.052	Bergeon 2819-A Set/3 Pins for Polygonal Cases	\$17.80
591.053	Bergeon 2819-B Set/3 Pins for Cases with Slots	\$13.50
591.054	Bergeon 2819-D Set/3 Pins for Grooved Cases	\$16.95

Jaxa Style Case Wrench

Modeled after the famous JAXA, but quite a bit less expensive. Provides a tight, non-slip grip that will not scratch or mar. Includes four sets of easy to insert jaw pins: round, flat, square and toothed. For all waterproof watch cases. Made in India.

590.099		\$7.25
---------	--	--------

Jaxa Style Wrench in Wooden Box

590.090		\$16.50
590.0791/1*	Set of Replacement Pins (special order)	\$6.25

Jaxa Style Waterproof Case Wrench (not shown-see above)

A quality wrench at an exceptional price. Nicely finished with non-slip grip. Includes six sets of pins for all waterproof watch cases. Storage case neatly and securely holds the pins. China.

590.092		\$9.95
---------	--	--------

Jumbo Jaxa Style Wrench for watches up to 55mm

Modeled after the famous JAXA, but quite a bit less expensive. Provides a tight, non-slip grip that will not scratch or mar. Includes four sets of easy to insert jaw pins: round, flat, square and toothed. For waterproof watch cases from 19mm to 55mm diameter. Made in India.

590.948		\$25.95
---------	--	---------

L-G Master Case Opener for Waterproof Cases

Opens any size or shape waterproof case - knurled, polygon, with any number of slots, notches or holes. The L-G patented closing system unscrews backs without scratching. Cover can be left in wrench, ready for replacing. Complete with 4 sets of interchangeable jaw pins. Made in USA.

590.055		\$82.95
---------	--	---------

Replacement Pins for 590.055

590.05501	Set of 12 (3 each)	\$24.95
590.05503	Set of 3 Multinotch	\$7.75
590.05505	Set of 3 Hexagon	\$7.75
590.05504	Set of 3 Knurled	\$7.75
590.05506	Set of 3 for Cases with Holes	\$7.75

Replacement Parts for No.590.055

590.05507	Center Shaft	\$3.75
590.05509	Adjusting Thumb Screw	\$7.50
590.05502	Screw	\$5.50

Adjustable Case Opener for Screw-Backs up to 61mm

5-in-1 tool opens waterproof watches with different type notches, without changing pins. Adjust width between pins easily by turning the knurled ring. Simply rotate the tool to select from five different shaped pins to fit notches of a variety of screw-back cases. Comfortable ball handles help you get firm, controlled pressure on case backs. 8¼" long, fits case diameters up to 61mm.

590.806		\$16.75
---------	--	---------

Horotec Maxi Press lets you open and close threaded cases safely, easily

The 6¹/₄" ergonomic hand wheel makes opening the most stubborn watch cases easy and safer for high grade watches. Includes 16 dies: 6 steel for O back cases, 3 steel for B back cases, 7 suction type for polished back cases. Also included are 4 pairs of pins for cases with round holes, square holes, sides and striated. Swiss manufactured to the highest tolerances to assure safe removal of threaded case backs. Handsomely finished to last you a lifetime.

- Center spindle with a precise blocking ring for adjusting height.
- Universal fixing system for all accessories.
- Removable case vise with concave pins to quickly center case.
- Solid steel supporting pillars with non-skin synthetic grips for right or left handed operation.
- Base has a removable die rack for easy selection and storage.

590.996 **\$1099.00**



The large wheel on the Maxi Press gives you the most power and precise control on all screw backs

590.996

Horotec Deluxe Case Opener

This Swiss made screw down case opener/closer features four sets of pins for opening a variety of cases. (A set of 6 dies for Rolex cases is also available.) This precision tool also features a removable sliding case holder to adjust to any case. Steel and aluminum Rock solid and manufactured to the highest tolerances to assure safe removal of threaded case backs. 7¹/₂" tall and nicely finished to last you a lifetime.

590.998 Horotec Deluxe Case Opener **\$359.00**

590.998.1 Replacement Nylon Case Holder Pin **\$8.75**

590.998.H Case Holder with 4 Pins **\$95.00**



590.998.1

590.998



590.998.A 590.998.B 590.998.C 590.998.D

Replacement Pins for Opener 590.998

590.998.A thru **590.998.D** **\$13.95 ea**

Opener gives you more leverage on screwbacks

Swiss made heavyweight tool from Horotec opens notched screw back cases with ease. Thumb screw adjusts the pins to fit up to 53mm case diameter. Pins may be interchanged with different pins from other Horotec case openers such as the MaxiPress.

590.202 6¹/₄" long **\$119.95**

590.896 7¹/₂" long **\$99.00**



590.896

590.884

Double Handle Opener for cases up to 60mm

Get twice the leverage and control on notched screwback watch cases with this Horotec opener. Thumb screw adjusts the pins to fit up to 60mm case diameter. Pins may be interchanged with different shaped pins from other Horotec case openers such as the MaxiPress. 10⁵/₈" long. Swiss made.

590.884 Horotec Case Opener **\$164.95**

590.884.1 Replacement Pin only for 590.884 **\$14.95 ea**



590.202

Genuine BERGEON Case Opener for Oyster Watches made by Rolex

Swiss made Bergeon 5700-RO Case Opener, Vise & Dies die-cast alloy tool includes:

- Adjustable case vise with non-mar plastic posts holds any shape of waterproof watch.
- Set of 6 milled rings with intermediate adapter for Oyster cases.
- Ring diameters: 18.5, 20.2, 22.5, 26.5, 28.3, 29.5mm.
- Two sleeper screws and wing nuts.

590.570

\$749.00

The Best Opener
made for Rolex
Oyster Cases

BERGEON

Swiss made



590.570



590.502



590.506



590.501.1



590.501



590.570.1

Accessories for Bergeon Case Opener 590.570

590.502	Bergeon 5538 Set of 6 Dies with Adapter	\$209.95
590.501	Bergeon 5674 Watch Vise	\$74.50
590.501.1	Bergeon 5674-D Post only	\$5.95

Reversible Case Holding Jaw -

synthetic to protect watch cases with 9-11mm lug widths.

590.570.1	Bergeon 5700-B Jaw	\$4.75
590.506	Bergeon 5700-04-G Upper Stake/Pin Holder	\$199.00

Pins for notched casebacks -

Require Superior Vise Holder 590.501

640.2835A	Bergeon 2835A Pin for Cases with Slots	\$9.50
640.2835B	Bergeon 2835B Pin for Polygonal Cases	\$9.50
640.2835C	Bergeon 2835C Pins for Cases with Holes	\$9.50
640.2835D	Bergeon 2835D Pins for Grooved Cases	\$9.50
640.2835E	Bergeon 2835E Pins for Cases with Curved Sides	\$9.50
640.2835F	Bergeon 2835F Pin for "Aquastar" Cases	\$9.50



640.2835A **640.2835B** **640.2835C** **640.2835D** **640.2835E** **640.2835F**

590.960

Optional mounting base screws to your bench top for securely holding the Openall.



590.0650

Made in USA

L-G Openall Waterproof Case Opener for Rolex Oyster

Designed to open Rolex Oyster® cases. The six tempered rings will fit every existing size. Because they are precision made to interlock, they will not slip. The sturdy cast frame fits into your bench vise and the small bar gives you the torque needed for stubborn case backs. The built-in adjustable case holder fits all sizes watches. L-G "Openall" can also be used in conjunction with the L-G wrench No.590.055. Ring sizes: 18.5, 20.5, 22.5, 26.5, 28.3, 29.5mm.

590.0650	Openall Opener	\$83.95
590.960	Base	\$15.50
590.961	Openall and Base	\$89.95
590.0655	Center pin	\$4.25

Replacement Rings for No.590.0650

590.0651/1	18.5 mm	\$7.95
590.0651/2	20.2 mm	\$7.95
590.0651/3	22.5 mm	\$7.95
590.0651/4	26.5 mm	\$7.95
590.0651/5	28.3 mm	\$7.95
590.0651/6	29.5 mm	\$7.95
590.0651/11	Torque Bar	\$3.25

Genuine BERGEON Opener for Rolex

Swiss made case wrench 5537 comes with six milled chucks, diameters 18.5, 20.2, 22.5, 26.5, 28.3 and 29.5mm to fit Oyster case backs manufactured by Rolex.

590.080

\$179.95



590.080

Economy Case Opener for Rolex

This opener comes with six milled chucks, diameters 18.5, 20.2, 22.5, 26.5, 28.3, and 29.5mm to fit Oyster case backs manufactured by Rolex. India.

591.0637

\$46.95



591.0637

Case Opener for Rolex

Comes with 7 dies: 18.5, 20.2, 22.5, 26.5, 28.3, 29.5, and 36.5mm

590.406

\$99.95



590.406

Horotec Case Opener for Baume & Mercier and Rolex

Swiss made case opener comes with nine serrated steel dies for opening and closing Rolex and Baume & Mercier screw-back cases. Large knob on the key gives you a firm, controlled grip. Dies also fit Bergeon and Horotec precision case openers.

590.250

\$289.95

Also available:

590.661 Case Opener w/3 Dies for Baume & Mercier **\$207.95**

590.662 3 Dies only 25, 30, and 33mm **\$127.95**

590.021 Die for Citizen Aqualand 35mm **\$62.95**

590.636 Handle only **\$67.95**

Case Opener Suction Dies with Handle

Handle with set of seven different aluminum snap-on dies. Dies have a special soft rubber gripping surface for opening screwbacks without marring or damaging watches. Dies create a suction grip and with a quick turn of the press, cases open easily. Dies fit Bergeon and Horotec case openers. Set of seven aluminum dies sizes: 16, 20, 22, 26, 30, 33 and 40mm diameters.

590.666

\$52.50



590.250



640.400

Ball Case Opener

Simply press this ball on a screwback case and twist. Soft plastic ball really grabs without marring a watch. 2½" diameter.

640.400

\$7.75 ea 3 @ \$7.25 ea 6 @ \$6.50 ea



590.666



590.000



590.775



590.022



Horotec Micro Press with Six Snap-on Dies

Swiss made case closer/crystal press features six nylon dies with nine different size cavities. Precise and accurate control without damaging cases. Dies range from 20mm to 39mm and easily snap on and off. Posts are in the rear for easy access to all watches. Steel and aluminum. 5" High.

590.000

\$117.95

Horotec MicroPress with Nine Screw-on Dies

Horotec precision tool for closing snap-back watch cases. Includes nine double-sided, non-marring nylon dies with brass screw-on centers. Steel and aluminum. 5" high. Swiss made.

590.775

\$229.00

Threaded Nylon Die for Crystals with Magnifiers

Die measures 35mm and features an opening so it won't damage crystals with date magnifiers. Screw-on center fits Horotec openers.

590.022

\$16.75



460.805

Case Closing Pliers

Parallel action plier with circular hinged rubber jaws. A steady gentle pressure snaps case shut.

460.805 Case Pliers

\$14.95

460.805.1 Replacement Jaws

\$3.25 pr



590.549



RLX Sky Dweller Case Opener Die

Specially made die for Rolex® Sky Dweller watch cases. 42mm diameter. Use with Bergeon and Horotec case openers.

590.549

\$89.00

Omega Seamaster Die Set

Set of two dies sizes 33 and 42mm to fit Omega Seamaster watches. Swiss made by Horotec.

590.888

\$79.95

Panerai Case Opener Die Set

Set of four handheld case openers for Panerai watches, includes sizes 40, 44, 45, and 47mm. Made of aircraft grade Aluminum, these openers are lightweight and durable. The built in handle allows for easy use without any extra tools.

590.425

\$74.95

Breitling Case Opener Die Set

Set of four handheld case openers for Breitling watches, includes sizes 34, 35, 36, and 38mm. Made of aircraft grade Aluminum, these openers are lightweight and durable. The built in handle allows for easy use without any extra tools.

590.426

\$74.95



590.888



590.425



590.426

BB Style Case Press with Large Dies Opens Wide

Deluxe press opens extra wide for closing cases and fitting all types of plastic watch crystals. Includes 14 reversible tapered/straight snap-on aluminum dies (24 to 38mm) for inner ring tension and regular crystals, one straight/flat die (33mm) and one flat supporting die (20mm). Heavy enough for bench use without riveting and the bench is notched to accommodate watch bracelet. Plier-grip extension for pressure control. Spring return. Lever can be locked into position for precise alignment. Made in USA.

590.158	BB Style Case Press with Dies	\$359.00
590.159	BB Style Case Press only	\$249.95
590.105	Large BB Aluminum Die 44-45mm	\$39.95
590.104T	Replacement Upper Die Holder BB	\$17.75



Made in USA

590.158



1 Pin Pusher w/Extra Pins

8 Aluminum Flat Dies Diameters 18-40mm

4 Plastic Dies for Cases 15-60mm

4 Rectangle Dies Widths 28-46mm

12 Aluminum Dies Diameters 14-46mm

590.795

Crystal/Case Press with 29 Dies

Multi-purpose press for closing snap back cases and installing watch crystals. Sturdy cast metal press makes battery changing easy for anyone. Press comes complete with 20 aluminum screw-on dies, 9 plastic dies and a pin pusher. Heavy base. Knurled handle has return spring and locking screw. India. Includes 12 Aluminum Double-sided Straight Wall Dies, 8 Aluminum Flat Dies, 4 Plastic Tapered Dies for Round Cases, 4 Plastic Dies for Rectangle Cases, 1 Plastic Flat Die, 1 Pin Pusher for Bracelet Links.

590.795	Crystal/Case Press with 29 Dies 16-40mm	\$39.75
590.872	Set of 6 X-Large Aluminum Dies 45-64mm	\$41.95



590.725

Jumbo Press for fitting almost all types of cases and crystals

Jumbo press includes 24 double sided friction-fit nylon dies for fitting flat mineral glass and snap back cases - up to 60mm diameter. Includes six rectangle dies. Heavy base stays put.

590.725		\$54.95
----------------	--	----------------

Press with Nylon Dies

This easy to use press closes any size snap back watch case. Cast metal press to ensure strength. Assortment of nylon dies, 21mm - 40mm, snap on and off quickly and they won't scratch or mar crystals. Watch sets face down so the repair person can see the case back being closed. Lever may be locked in place. India.

590.796	Case Press with 12 Nylon Dies	\$32.95
590.802	Set of 8 Larger Nylon Dies 35-57mm	\$12.95



590.796



Set of 15 Breitling Dies

Comes in wooden storage box.

590.407

\$495.00



641.2533

590.049

Suction Case Opener

For waterproof and screw back cases.

641.2533 Bergeon \$25.95

590.049 Economy Opener \$3.50



Rubber Vacuum Case Opener

For opening and closing screw backs and bezels. Has two sizes of cups for 0 to 18s watches.

591.048

\$5.85



590.794



590.798

G-S Snap-Type Case Press

Sturdy metal press for closing snap-type watch case backs. Includes 6 round and 4 rectangular metal adapters to accommodate most types of watches.

590.798

\$197.50

G-S Case Press Complete Set

For fitting G-S Ring Crystals and PA Waterproof Crystals. Also closes snap-type watch cases. Set includes 20 adapter cups, 6 rubber plugs, and 4 metal rectangular adapters.

590.794 G-S Crystal/Case Press Complete Set HP-5 \$359.95

590.973 Case Press only for G-S \$117.95

590.974 Handle only for G-S \$31.50



590.799



640.5500.A

Crystal/Case Press with Non-Marring Dies

Screw down press for fitting mineral crystals and closing watch cases. Large knurled handle. Non-marring nylon dies in sizes 37, 31(2), 24, 19, 18 15, and 14mm. India.

590.799

\$21.95

Genuine BERGEON Crystal Press Set with 28 Dies

Complete set for fitting unbreakable watch crystals with or without tension ring. Die-cast alloy press has an opening in the base to allow the insertion of metal bracelets fixed to watches.

Set NO. 5500-A includes:

- Press No.5500 with screw for mounting to the base.
- Set of 12 Aluminum Upper Reversible Dies 15-44mm diameters.
- Set of 9 Basic Aluminum Dies 13-33mm diameters.
- Set of 9 Basic Plastic Curved Dies 12-40mm diameters.
- Lower Stake and Support.
- Wooden base, 14³/₈" x 6", with screws are also included for mounting the base to your bench.

Not suitable for fitting mineral crystals. Swiss made.

640.5500.A

\$539.00

BERGEON

590.555



Genuine BERGEON Crystal Press

The Bergeon 5500 crystal press securely installs snap back cases, and outer tension ring and regular watch crystals. Expansion bands stay on the case when fitting crystals. Die-cast press comes with 15 double sided straight wall metal dies 22 - 36.5 mm.

590.555

\$417.95

640.5500-4 Set of 4 Large Dies 5500-40-XL

\$112.95

Fit cases up to
64mm Diameter

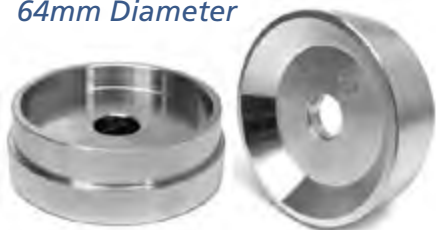

Large Dies for BB Crystal/Case Press

Double-sided Tapered/Straight aluminum dies available in six sizes providing diameters 45mm to 64mm. Friction fit.

590.521	45-47mm	\$18.25
590.522	50-53mm	\$18.75
590.523	54-55mm	\$19.50
590.524	55-57mm	\$19.95
590.525	58-60mm	\$20.50
590.526	62-64mm	\$21.00
590.527K	Set of all 6 of above	\$105.00

Also available:

590.543	40-43mm	\$17.75
----------------	---------	----------------



Genuine BERGEON Large Case Dies

Set of four Large Threaded Aluminum Dies (or Stakes) for use with the Bergeon 5500, Horotec and other case presses that accept screw-on dies. Reversible dies in diameters: 52/50, 56/54, 60/58 and 64/62mm. Swiss made.

640.5500-4	\$112.95
-------------------	-----------------



Set of 6 LARGE Aluminum Dies

Large aluminum dies accommodate larger watches. Use with our 590.795 combination case closer/crystal press. Set includes the following size dies:

- 45-47mm
- 50-53mm
- 54-55mm
- 56-57mm
- 58-60mm
- 62-64mm

590.872	\$41.95
----------------	----------------



Large Die for BB Style Press

Double-sided Straight aluminum die size 44.0-45.0mm for BB case press 590.104.

590.105	\$39.95
----------------	----------------



Flat Upper Dies for BB Style Press

Solid aluminum flat support dies fit the BB style press. Two diameters available.

590.527	40mm	\$14.50
590.528	50mm	\$15.50
590.529	Set of 2 Sizes	\$27.95



Die Holder for BB Style Press

Replacement triangular upper die holder for the 590.104 BB case press and friction fit dies.

590.104T	\$17.75
-----------------	----------------



590.540

590.542

Aluminum Dies for Rolex

Two four-piece sets of aluminum dies to open Rolex watches with you Bergeon or Horotec opener. Each set includes four sizes: #2 Ladies, #4 Mid-Size, #7 Men's and #8 Sub & GMT.

590.540	Set for Bergeon 5700	\$124.95
590.542	Set for Horotec Maxi	\$124.95



Case Dies for Rolex Watches

Set of 7 different size aluminum dies for pressing Rolex and other high-grade bezels and snapback cases. Nylon inserts won't mar valuable watches. Friction fit to work with tools like the BB Press 590.104. (Note: these do not fit our 590.107 press).

590.804	\$97.50
----------------	----------------



Dies for Fitting Rolex Bezels with the BB Press

Non-marring plastic dies for fitting Rolex bezels. Friction fit your BB Crystal/Case Press. 28, 33 and 38mm diameter.

590.530	28mm Ladies'	\$15.95
590.531	33mm Boy's	\$15.95
590.532	38mm Men's	\$15.95



Horotec Case Opener Dies for Panerai Style Watches

Set of four dies to open Panerai style watches with 12-sided screw-backs. Includes numbers: 07 334 030, 07 332, 07 334 035 and 07 334 042. Swiss made for Bergeon & Horotec openers.

590.809 Set of 4 **\$349.95**

Individual Dies for Panerai

590.519	40mm	\$79.95
590.508	44mm	\$79.95
590.509	45mm	\$79.95
590.518	47mm	\$79.95
590.500	Arktos - GMT	\$79.95
590.548	38.5mm 12 Sides	\$79.95



Case Opener Die for Panerai Arktos GMT

Open 12-sided screw-back Panerai Arktos watches. Use with Bergeon and Horotec case openers.

590.500 **\$79.95**



Dies for Baume & Mercier

Horotec Swiss made serrated steel dies 25, 30 and 33mm for opening and closing Baume & Mercier screw-back type B cases. Fits Bergeon and Horotec case openers.

590.662 **\$127.95**



Dies for Seamaster Cases

Five pegs for opening Seamaster and DeVille watch cases. Fits your Horotec or Bergeon table top opener.

590.811	for Ladies'	\$43.95
590.81101	for Men's	\$44.95
590.808	Set of Both	\$79.95



Case Die for Citizen Aqualand

Specially made for opening Aqualand cases with five notches. 35mm diameter. For Horotec or Bergeon openers. May be used with handle 590.250 and 590.661.

590.021 **\$62.95**

Horotec Suction Case Die Set of 10

Special soft rubber gripping surface for will not mar or damage screwbacks. Dies create a suction grip and with a quick turn of the press, cases open easily. Fit Bergeon and Horotec openers. Set of ten aluminum dies sizes: 16, 20, 23, 26, 30, 34, 40, 45, 50 and 55mm diameters.

590.655 **\$399.95**

Individual Dies

590.826	20mm	\$32.00
590.827	30mm	\$46.50
590.824	34mm	\$39.95
590.825	40mm	\$39.95



Die for Deep Sea Dweller

Case back opener for Deep Sea Dweller fits Bergeon and Horotec 36.5mm openers.

590.558 **\$79.95**



Case Opener Dies for Breitling

Precision dies specifically made to open Breitling case backs with 13, 14 and 15 sides. Use with case openers such as our Bergeon and Horotec openers 590.998, 590.996, 590.250, 590.661 or 590.570. Measurements are approximate.

Number	Diam.	Sides	Fits Cases
590.510	31	14	D33030
590.511	34	15	A13358, A49350, A53350, A73350
590.512	26	13	67365, A71356
590.513	34	15	A17350, A35312, A74350, A10350
590.514	42	15	A13370, A24322
590.515	36	14	A13340
590.516	36	15	A32350, A17360

\$79.95 ea

Set of all above seven Breitling Dies

590.517K **\$495.00**

Also available:

Number	Diam.	Sides	Fits Cases
590.517	18.50	11	E70176, A70174
590.547	23.80	13	A72345
590.536	26.50	13	
590.503	28.00	15	
590.546	28.80	15	
590.535	30.22	14	
590.537	31.33	15	
590.538	36.30	15	
590.651	37.00	15	A17320
590.650	38.00	15	13355, A13356, A23222, A42362, A44355, A45355, B13356, C13356

590.507 Chromatic 15 Sides A14360

\$79.95 ea



Die for Breitling Bently

Precision die specifically made to open Breitling for Bently A44362 case, 5 sides.

590.534 **\$77.50**



Dies for BIG Cases

Set of 5 reversible screw-on dies in special large sizes: 40/45, 46/48, 46/50, 47/50 and 49/50. Long-lasting, non-marring delrin plastic with brass threaded centers. Swiss Horotec. For use with our 590.775 MicroPress.

590.122 **\$89.95**

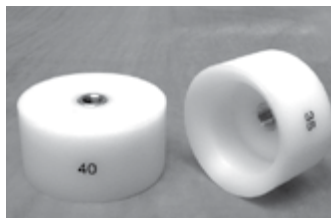

Delrin Dies for fitting high dome crystals

Set of 12 Horotec screw-on dies for fitting high dome crystals, sizes 18 thru 65mm. Swiss made for crystal/case press such as our 590.780.

590.161 **\$159.00**

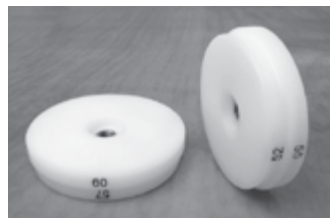

Delrin Dies for flat mineral glass crystals

Set of 4 Horotec reversible screw-on dies for fitting large flat mineral glass crystals, sizes 47 thru 65mm. Swiss.

590.162 **\$67.50**



Nylon Die for Watch Crystals with Magnifiers

Threaded Die measures 35mm and features an opening so it won't damage crystals with magnifiers. Screw-on center fits Horotec openers.

590.022 **\$16.75**



Extra Large Nylon Dies

Five double sided dies providing 10 different sizes: 40.0/42.5, 45.0/47.5, 50.0/52.5, 54.0/55.0, 56.0/57.0mm. Also includes 3 flat dies 35, 40 and 45mm. Dies fit our case press 590.796.

590.802 **\$12.95**



Large Dies for snap-backs

Set of 6 Horotec reversible snap-on dies for closing large watch cases, sizes 52 thru 65mm. Includes 3 upper and 3 lower dies. Swiss made for crystal/case press such as our #590.780.

590.160 **\$82.95**

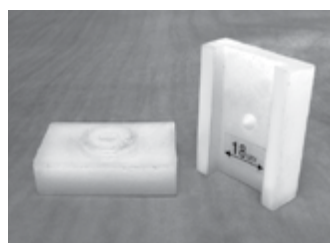

Rectangle Nylon Dies

Set of 5 dies for fitting square or rectangle watch crystals and cases 15mm - 24mm. Use with case press 590.795 or 590.796.

590.020 **\$8.95**

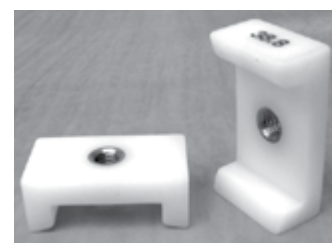

Rectangle Delrin Die Set

Set of six non-marring delrin dies for fitting square and rectangle style snap-back watch cases. Screw-on dies come in a handy case. Die mm sizes (Length x Width): 24 x 13, 34 x 19, 44 x 25, 29 x 16, 39 x 22 and 49 x 28.

590.037 **\$47.25**

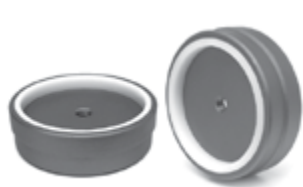

Case Press Dies for Large Watches

Set of 4 reversible screw-on dies in large sizes 50 thru 64. Aluminum dies have non-marring nylon inserts and threaded centers. Fit Bergeon Press 590.555.

590.805 **\$31.50**



Plastic Case Dies For BB Style Press

Plastic double sided case back dies, perfect for use in a BB Style Press. Available in 8 different sizes, sold individually.

590.614	40X42	\$12.95
590.615	45X47	\$12.95
590.616	50X52	\$13.95
590.617	53X55	\$14.95
590.618	55X57	\$14.95
590.619	58X60	\$15.95
590.620	60X62	\$15.95
590.621	62X64	\$15.95



Case Dies RADO Watches

Non-marring hard nylon dies protect crystal and crown when closing RADO watches. Dies fit BB style presses. 48mm square overall, sizes listed are Round Diameters and Rectangular Width x Length of Curved Section.

590.151	Round Small 23.0mm	\$31.50
590.152	Round Medium 31.5mm	\$31.50
590.153	Round Large 33.5mm	\$31.50
590.154	Rectangular Small 19.2mm x 22.0mm	\$31.50
590.155	Rectangular Medium 24.3mm x 28.0mm	\$31.50
590.156	Rectangular Large 27.4mm x 34.0mm	\$31.50
590.157K	Set of all Six	\$169.95

MOVEMENT HOLDERS



Horotec Reversible Movement Holders

Finest quality steel for smooth, precise operation. Swiss. Small adjusts to fit sizes 3³/₄ to 11 ligne. Large holder adjusts to fit pocket watches 8³/₄ to 19 l.

590.241 Small **\$20.75**

590.240 Large **\$23.95**



Reversible Movement Holder

Aluminum holder adjusts to fit calibers up to 12 ligne. India.

590.281 **\$3.95**



Eight-Way Holder

Nickel plated brass with double notches on each side. Adjusts with thumb screw to fit almost any movement. India.

590.287 **\$5.50**



Bestfit Two-Way Holder

Reversible brass holder will take all shapes and sizes up to 12¹/₂ lignes.

591.280 **\$30.95**



BERGEON Reversible Movement Holders

Small Bergeon 4039 adjusts to fit calibers 3³/₄ to 11 ligne. Large Bergeon 4040 fits calibers 8³/₄ to 19 ligne.

590.403 Small #4039 **\$23.75**

590.404 Large #4040 **\$26.50**



BERGEON Reversible Plastic Movement Holder

Plastic holder won't mar delicate movements. Fits calibers 8³/₄ to 19 ligne.

640.4040P **\$25.95**



Holder for ETA 251.471 movement

For ETA 251.471 Chronograph Movement. Swiss made.

590.682 **\$41.95**



Holder for ETA 252 series movements

For ETA 251.252, 251.262, 251.265 and 251.272. Swiss made.

590.682.2 **\$52.50**



BERGEON Reversible Movement Holder

Reversible dial side, 16¹/₂ ligne. Swiss made. Bergeon 5914 DI 1612.

640.5914.1612 **\$41.95**



Plastic Holder for Valjoux 7750

Affordable holder is specially made for the 13¹/₄ ligne Valjoux 7750 movement.

590.600 **\$10.50**



Holder for Valjoux 7750 movement

For Valjoux 7750. Swiss made.

590.682.3 **\$41.95**



Horia Holder for Valjoux 7750

Precision holder specially designed to hold Valjoux 7750. Swiss made.

590.7750 **\$465.00**



Holder for extra large watch movements

Reversible aluminum holder accommodates odd shaped and large movements up to 75mm. 3 1/2" adjusting screw.

590.286 **\$6.25**



Reversible Holder

Holds movements up to 18 lignes. Room for clearance of curved plates and winding stems. Swiss made.

591.284 **\$83.55**



Baguette Holder

Designed to hold baguette and very small movements. Easier to work with than larger size holders. Cut-outs provide clearance for winding stems. Swiss made.

591.278 **\$85.50**



Movement/Case Vise

Extra heavy-duty aluminum vise with thumb screw is ideal for holding waterproof cases when removing backs. Fits in bench vise.

591.0300 **\$21.85**



Wood Vise won't mar watch cases

Wood will not scratch a watch case. Stable holder is larger than most, accommodating any size watch case. India.

590.086 **\$5.75**



Set of 3 Case Supports

Hard black nylon with replaceable sponge rubber inserts to protect the crystal, bezel and case from damage. Works with all types of watches. Inside diameters: 24, 30 & 40mm. Outside: 50mm x 25mm high. Swiss made.

590.244 **\$99.95**



Movement Holders for Hand Setting Tools

Holders have adjustable hollow center screws. Heavy steel bases are 31mm diameter. Available in three sizes.

590.140 for 8 3/4 ligne **\$52.50**

590.141 for 11 1/2 ligne **\$49.95**

590.142 for 10 1/2 ligne **\$52.50**



Movement Holders for Rolex

Specifically made to fit three different Rolex movements. Each has an adjustable center pin which provides support for the movement's center jewel. Quality finished aluminum.

590.851 for 1570 **\$26.95**

590.852 for 2135 **\$26.95**

590.853 for 3035 **\$26.95**



Economy Large Movement Holder

For pocket and large watches popular today. Solid metal holder fits in any bench vise. Four adjustable pins made of non-marring nylon can be set if four positions.

590.030 **\$15.75**



Large Movement Holder

Handles pocket watch and large chrono-graph movements. Heavy metal frame fits in any bench vise. Large knurled knob for easy adjustment. Plastic non-marring posts can be set in four positions.

590.125 **\$121.25**

590.125.2 Extra Peg **\$7.95**



Genuine BERGEON Jaxa Case Vise

Plastic posts and frame prevent marring. Posts are removable and can be set into different positions for different cases. Large knurled knob. Fits into bench vise. Bergeon 5090

591.088 **\$65.50**

591.089 Extra Post **\$5.95**



Case Holder

Comparable to holders at twice the price. Holds any size screw back case. Hard plastic adjustable pillars are contoured to fit and hold case safely and securely. Base fits any bench vise. India.

590.089 **\$6.25**



Watch Case Holder with Adjustable Clamp

Fits in a vise and clamps onto a watch case with a twist of the outside rim. Posts stay tight while opening screw-backs. Posts have soft plastic sleeves to protect case; a foam cushion protects crystal. 3" diameter, fits cases 28 - 51mm.

590.613 **\$22.95**



Genuine Bergeon Dial Base

Hard plastic stand has holes to accommodate dial feet and keep a dial secure while you work on it. 2" diameter for all sizes of dials.

640.7053N **\$76.95**



Genuine Bergeon Holder for Adjusting Balances

This tool has 10 different size holes for balances. Made of non-marring delrin. 36mm diameter.

640.30106D **\$58.75**

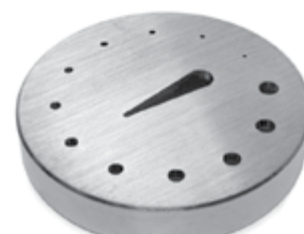

Genuine Bergeon Hairspring and Balance Holder

Swiss made brass holder 39.9mm diameter.

640.30106 **\$48.25**

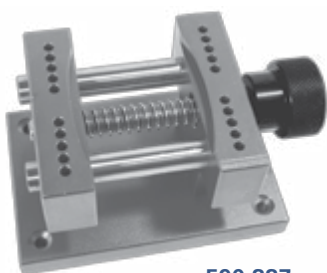

590.887

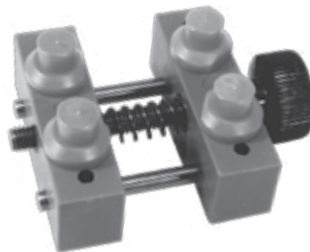

640.6769

Swiss Style Jumbo Watch Case Holder

This heavy duty case holder can be mounted to a bench with ease. Comes with four plastic pins to fit watches up to 60mm.

590.887 **\$63.50**

Universal Jaxa Watch Vice

Non-marring plastic posts are removable and can be placed in different positions for different cases. Frame fits into bench vise. Expands up to 55mm. Swiss Made.

640.6769 **\$46.95**



590.201



590.953

Case Holder Bench Vise

Clamps on to the edge of your bench. Metal vise adjusts to hold any size watch case. Double shafts. India.

590.201 **\$6.50**

Horotec holder for watches with integrated bracelets

Specially made for securing one-piece watches with bracelets that are part of the case. Includes a 39mm nylon die that can easily be replaced with other sizes you may have with a case press. Heavy base measures 4 1/8" x 2 3/8" and has rubber gripping feet. Swiss.

590.681 **\$62.95**

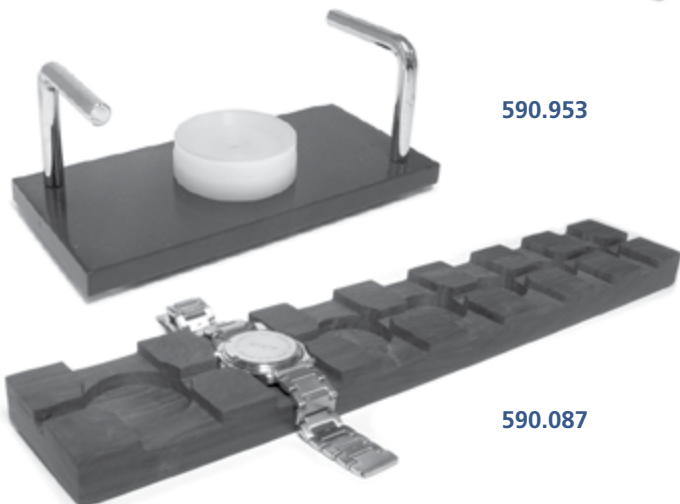

590.953

Economy holder for watches with integrated bracelets

This watch holder is designed to hold watches with plastic or metal integrated bands that refuse to lay flat while you're trying to repair the watch. Two bars hold the band apart to give you a clear view and allows you to use both hands on the watch. Nylon die in the center won't mar or scratch the watch.

590.953 **\$18.95**

Hardwood Lap Case Holder

A Cas-Ker Exclusive! Use this solid hardwood holder on your lap with a case opener to apply extra pressure and control on a screwback case. Won't mar watch cases. Seven different spaces for watch diameters 25mm thru 45mm. 1 5/4" x 2 3/4" x 3/4".

590.087 **\$26.25**

Fercal Bezel Adjusting Tool for Rolex

Safely tighten or loosen a bezel to stop leaks or cracked crystals resulting from an incorrectly sized bezel. Device designed to increase or decrease the diameter of Rolex bezels and bezel inserts. Stainless steel with protective case. Protective case includes ergonomic carrying handle.

590.058

\$1195.00



590.058

Genuine Bergeon 6820 Lift removes diver bezels quickly and easily

This tool from Bergeon extracts bezels from diver watches. Provided with 3 adjustable clamping jaws (height 3.5mm) of hardened and tempered steel, suitable for bezels ranging in diameters from 27mm to 45mm. Jaws lock automatically by position-indexing spring balls. Bezel is clamped by the knurled knob. Includes 2 beveled extraction stakes (17 and 22mm diameters) and Allen key. Switzerland.

590.664

\$398.50



590.664

Vise makes it easy to polish cases, bezels and rings

This aluminum vise fits on your polishing motor. Four tempered steel jaws securely hold a watch case for polishing or applying a satin finish. Claws adjust to hold items from the inside 12mm - 34mm in diameter. Handle opening 14mm (fits 1/2" motor shafts). Vise may also be used off the motor as a holder. Non-roll handle. Swiss made by Horotec.

470.519

\$229.00



470.519

Bergeon 7820-10 Bezel Extractor

Ergonomics make it easier to extract all kinds of bezels from 20mm to 58mm diameter. This unique device offers the possibility of integrating various chucks and tightening jaws to adapt to the majority of bezel shapes. Anodized aluminum handle, universal nylon chuck and 3 sets of removable jaws; 15°, 30° and 40°.

640.7820

\$839.95



640.7820



640.7820.1

Support for Bezel Remover

Offers the best stability for removing bezels with the Bergeon 640.7820 tool.

640.7820.1

\$349.95

Horotec Bezel Remover

Easily remove watch bezels without risk of damaging them. The four blades of the bezel remover comes with tapered edges, and are controlled by the easy to use knob. Opens up to 60.0mm.

590.660

\$279.00

590.660.B Replacement Blade

\$34.95

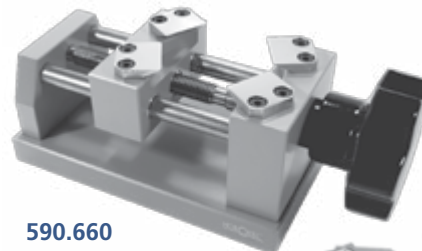

590.660

Remove Bezels without damaging expensive watches

Four sharp tapered knives on this tool let you pry watch bezels easily without marring case or bezel. Heavy weighted base for stability. Large knurled knob allows for smooth, precise control over most size bracelet watches. Ideal for removing solid gold Rolex bezels.

590.665

\$189.95

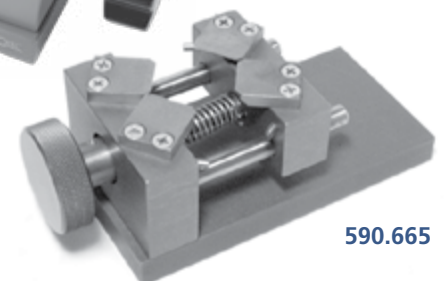

590.665

590.667



Genuine Bergeon 4266 Universal Crystal Lift

Removes and inserts crystals without disassembling the watch. For any unbreakable crystals 10 to 45mm without tension ring. Includes platform for inserting crystal. Swiss made.

590.667

\$83.95

590.102



Economical Crystal Lift

Replace round crystals without taking watch apart. Simple turning action opens and closes brass fingers which grip crystal. For crystals 15 to 45mm. Includes platform for inserting crystal. India.

590.102

\$16.95

640.5011



Bergeon Crystal Pump for One-Piece Cases

Swiss made air pump removes unbreakable crystals from one-piece watch cases by pumping air into the crown opening. Swiss watch manufacturers have carefully tested and proven that a momentary increase in pressure has no effect on the timekeeping of a watch, on its components or on the retention of oil in jewel holes. Includes three sizes nylon tips (1.6, 2.0 and 2.5mm) and a special key for removing half-stem with the crown.

640.5011

\$156.95

590.602



Flexible Bezel Remover

Swiss made flexible plastic ring for removing all sizes of watch bezels. 1 7/8" inside diameter will spread to fit larger bezels.

590.602

\$21.95

130.900



UV Glue Curing Lamp

Made for curing ultraviolet crystal cement. Black plastic fixture measures only 7 1/2" x 4 1/2" x 2 7/8". Takes up very little space. Includes 6" UV bulb, 5 1/2' cord with 2-wire plug and on/off switch. 110V AC. Two minute curing time.

130.900 UV Lamp

\$39.95

130.901 Bulb

\$10.95

120.226



Crystal Clear® UV Adhesive

Uses the power of the sun or our curing lamp to bond metal to glass instantly. Clear, non-yellowing. No-mess needle applicator.

120.226 .07 fl oz

\$6.50

120.002 Needle Tip

\$1.50

Check out our extensive selection of Watch Crystals on pages 418-425.

130.905



UV Curing Lamp with Timer

Ideal for curing ultraviolet crystal cement. White plastic fixture measures 8" W x 4" H x 9.5" D. Includes four 9W UV bulbs, 5.5' cord with 2-wire plug, on/off switch and timer with 90 and 120 second selections.

130.905 UV Glue Curing Lamp

\$119.95

130.906 Replacement Bulb

\$10.50

Scratch Remover Kit

High performance scratch remover for glass, from PolyWatch. Repair scratches on watch crystals, smartphones, windows, car, furniture and more. Kit sufficient for 30-40 applications.

470.523 **\$18.95**

PolyWatch® makes plastic crystals shine like new

Special purpose polishing paste removes scratches from plastic crystals quickly and cheaply. Use just a small amount with a soft cloth and rub scratches for 2-3 minutes. Tiny abrasive particles ground down the plastic. Enough polish for 10-12 applications.

471.001 **\$5.50**

Crystal Bright Scratch Remover

The perfect compound for removing scratches from plastic watch crystals. This is a money saver and extremely easy to use by charging your buffing wheel with a small amount of compound. Crystal Bright may also be used with a selvylt cloth if scratches and abrasions are minor. Using Crystal Bright in a gentle buffing motion can make old crystals look brand new. 3 oz.

470.311 **\$4.50**

Crystal-Kleer Plastic Renewer

Makes old crystals new again by removing scratches and blemishes. Every repair can have a crystal that looks brand new. Easy to use - charge wheel with compound and gently buff crystal.

470.310 **\$8.95**

Bergeon Pen Polisher for Watch Crystals & Dials

This pen is ideal for cleaning watch crystals without touching the case. Can also be used for cleaning dials without leaving marks. Also useful for cleaning precious stones and loupes. Provides better results than rubbing with cleaning cloths or swabs. Retractable soft brush on one end. Lightweight, easy to use and tips are easy to change. Supplied with round concave tip #7971-A.

640.7971 **\$28.50**

G-S Crystal Gauge

For round bezels and fancy cases. One side is a millimeter scale for measuring crystals sized in millimeters. The other side is for measuring round sizes from extreme edge of gauge in millimeters 8.4 to 12.7mm and sizes 1/4 to 100.

590.293 **\$4.50**

Sternkreuz-Minecol Adhesive

Special cement for fitting mineral glass crystals. Fine hypodermic syringe for pinpoint accuracy. Cures in 2-3 minutes under a UV lamp. Light-proof bottle protects Minecol against hardening. 2ml

120.007 **\$19.95**

Glass Glue bonds without a UV lamp

Flexible, waterproof and heat resistant. Clear bond line makes repairs disappear. Bonds in 60 seconds, cures in 24 hours. No ultra-violet lamp required for curing. 2 gram

120.233 **\$4.95**

G-S Hypo-Tube Crystal Cement

Unique precision applicator and pinpoint tip. Dries clear and allows parts to be positioned before setting. USA. 1/3 oz.

120.205 **\$5.95**





640.5409



590.938



591.0520



590.920



420.305



420.310
420.311



121.227



351.175



640.7153



590.988

590.989

Bergeon 5409 Movement Holder

Universal holder for fitting hands. Adjustable height.

640.5409

\$114.95

Swiss Dial Protector for removing hands

Just slide this thin plastic protector under watch hands when you're prying them off. Hand tools won't scratch valuable dials.

590.938

\$3.25/pack of 3

Watch Hand Holder

Holds miniature parts such as watch hands while being broached. Holder has 10 holes.

591.0520

\$38.50

White Dial Enamel

Comes with measuring cup and spatula. Japan.

590.920

\$19.95

Cas-Ker Luminous Paste Kits

All you need to mix luminous paste for watch dials and hands with the right consistency and quantity every time. Available with white, green or yellow luminous powder. Kits also include glue, diluent, mixing cup and applicator.

420.305 White

\$49.95

420.307 Green

\$49.95

420.309 Yellow

\$49.95

Bergeon White Luminous Paste Kit

Genuine Bergeon kits have all you need to apply luminous paste to hands and dials; non-radioactive powder, varnish, thinner, mixing cup and applicator. Swiss.

420.310 White Bergeon 5680-B-07

\$49.95

420.311 Blue Bergeon 5680-BE-07

\$59.75

Orange Flake Shellac

Orange flake shellac is sticky when heated, making it useful for holding objects. Use to cement pallet jewels and roller jewels. 6oz.

121.227

\$19.95

Hole Diameter Sizer

A useful gauge for quick, accurate measurement of inside diameters of drilled holes or nuts. The pinwheel gauge features 10 spokes from 1.0mm to 2.2mm diameter.

351.175

\$10.05

Bergeon Support Base

Synthetic support base for watch dials. Many small holes allow for easy and simple positioning of the dial feet. .60mm x 8mm.

640.7153

\$59.95

Genuine Bergeon Non-marring Polystyrene Sticks

Red stick aids in holding down bridges and springs for assembly. Won't damage parts. 5³/₈" long with one pointed and one flat end.

590.988

\$3.25 ea 3 @ \$2.95 ea

Transparent plastic Bergeon stick has more strength than other types and can be sharpened without flaking. 5⁷/₈" long. Swiss.

590.989

\$14.25 ea 3 @ \$12.75 ea

Genuine Bergeon 30012 Hand Levers

Set of two large levers for removing watch hands have notches to prevent slipping and damage to dials. 4⁵/₈" long. Swiss made.

590.855 **\$87.95**

Genuine Bergeon 30019 Fine Hand Levers

Hardened steel levers for removing watch hands. 2.5mm wide x 0.20mm thick polished tips, 110mm long with knurled grip. Set of two. Swiss.

590.309 **\$78.75**

Swiss Hand Levers

Precision Swiss made levers for removing watch and clock hands. Use two non-marring levers together to pry off watch hands.

4¹/₄" long. Two sizes available in sets of two. 2.5mm for bracelet watches, 4.0mm for pocket watches and small clocks.

590.840 2.5mm **\$49.25 pr**

590.841 4.0mm **\$48.75 pr**

Set of Two 3.5mm Swiss Hand Levers

Use this set of two VOH steel levers together for removing watch and clock hands. 3¹/₂" long. 3.5mm wide for bracelet watches.

590.720 **\$99.00**

Bergeon Hand Levers for those who demand the best

Finest quality Swiss levers for removing watch hands. Polished hardened steel tips have notches for precise placement. Tips are 2.5mm wide x .15mm thick with a 70° lever angle. Blue anodized aluminum knurled handles. 4¹/₈" long. Set of two. By Petitpierre.

640.30018 **\$234.95**

Horotec Swiss Made Hand Levers

These will safely lift the smallest of watch hands. Forked tips are 1.00mm wide, tools are 4¹/₈" long with plastic covered handles.

590.833 **\$29.95 pr**

Swiss made Hand Fitting Tools won't scratch dials

Plastic ends on these hand tools won't scratch watch dials. Each tool has two different diameter holes; 0.50/1.00mm and 0.8mm/convex. Anodized aluminum knurled handles. 4⁵/₈" long.

590.712 **\$29.95**

590.712.001 Replacement Tip Concave .001 **\$3.25**

590.712.50 Replacement Tip Black .50mm **\$3.25**

590.712.100 Replacement Tip White 1.00mm **\$3.25**

Genuine Bergeon 7404 Hand Fitting Tools

Set of three watch hand tools with hole diameters 0.50, 0.80, 1.00 and 1.80mm, plus plastic and brass flat ends for second hands and two-hand watches. Color coded tips and anodized aluminum knurled handles. 4³/₈" long. Swiss made.

590.644 **\$66.95**

Genuine Bergeon 7404-1 Hand Setting Tool

Two pierced end pieces fit hands without damage. Applies pressure only to the hole section. Recommended for quartz.

590.641 **\$18.75**



590.855



590.309



590.840

590.841



590.720



640.30018



590.833



590.712



590.644



590.641



590.639



590.820



460.365



590.864



640.30544



640.30543.AP



641.30020

Horotec Set of 4 Hand Fitting Tools

Plastic ends on these hand tools won't scratch watch dials. Each tool has two different diameter holes; 0.50/1.00mm and 0.8mm/concave. Anodized aluminum knurled handles. 4³/₈" long.

590.639

\$52.50

Horotec Double Ended Hand Fitting Tool

Two pierced end pieces, 1.5 and 2.0mm diameters, fit watch hands without damaging them. Applies pressure only to the hole section of the hand. Swiss made with knurled aluminum handle.

590.820

\$16.75

Watch Hand Cutting Pliers

Perfect for cutting off stick hands. 5" long, plastic coated handles.

460.365

\$10.95

Horotec Watch Hand Fitting Tool on Stand

Swiss made tool for fitting hands onto watch movements. Comes with eight plastic dies and a rotating stand. Die tip diameters (interior/exterior): 0.00/2.00, 0.30/2.50, 0.80/2.60, 0.95/2.80, 1.10/2.90, 1.35/3.00, 1.50/3.20 and 2.10/3.50.

590.864

\$139.00

Genuine Bergeon Set of Seven Cutting Broaches

Broaches from Bergeon feature PVC handles for comfort and control. Seven broaches range in sizes 49mm thru 104mm. Swiss.

640.30544

\$81.95

Bergeon Smoothing Broaches Set of 7

Set of seven different sizes smoothing broaches with plastic grip handles. Nos. 32-70, diameters 3.53 - 0.69mm. Swiss made.

640.30543.AP

\$76.95



641.30013

Bergeon 30013 Levers for Hairspring Collets

Set of two levers for removing hairspring collets. Swiss made.

641.30013

\$79.95

**More broaches
on page 134.**

Bergeon Broach and Lever Set

Assortment of 12 levers for lifting hands and for removing, turning and setting hairspring collets. Swiss. Bergeon 30020

641.30020

\$329.00

BERGEON

Bergeon 8935-4 Hand Setting Tool by Petitpierre

Swiss made tool features three stakes with plastic tips for safe, precise hand setting. The tool holder swivels and snaps in place for perfect alignment. Stakes have color bands for quick size identification.

640.8935.4

\$995.00



640.8935.4

Horotec® Watch Hand Press

Precision tool to press hands onto watch movements. Safe for dials, this press comes with eight nylon dies to fit a variety of hands. Nicely finished Swiss made tool will last you a lifetime.

590.245

\$89.25

Replacement Parts

590.246	Spring	\$8.50	590.245.90	Die 0.90	\$8.50
590.245A	Shaft	\$17.75	590.245.1.20	Die 1.20	\$8.50
590.245.H	Die Flat Cone	\$8.25	590.245.1.50	Die 1.50	\$8.50
590.245.G	Die Flat	\$8.25	590.245.1.70	Die 1.70	\$8.50
590.245.70	Die 0.70	\$8.50			

Watch Hand Setting Tool Set

This set includes the tool, nine different stakes and a heavy weighted base to keep them in easy reach. India.

590.714

\$26.25



590.714

Bergeon 30464 Watch Hand Gauge

Swiss made gauge measures hand holes easily and accurately.

590.301

\$54.50



590.301

Hand Pressing Tools

Set of three tools provides six sizes. India.

590.710

\$6.75



590.710

Genuine Bergeon 5060 Swiss Timer Hand Remover

Use of the lantern-chuck allows for a quick, trouble-free hand removal. Will not damage dial since pressure is placed evenly.

641.5060

\$49.95



641.5060

Horotec Hand Tweezers

The round mirror polished tips and angular neck makes it easier to set hands on watches with high markers on dials. 100% anti-magnetic. 120 mm. Swiss made by Horotec.

570.868

\$79.95



570.868

Special Tweezers for Watch Hands

Fine quality stainless steel tweezers are 100% anti-magnetic. They feature smooth rounded polymeric tips for working on hands of high grade watches. Pattern F1, 4 3/4". Swiss made by Horotec.

570.980

\$59.95



570.980



590.310

BERGEON PRESTO #1 Hand Remover

Pusher blocks have fiber tips that will not mar the dial. Jaws retract when side springs are pressed. Center plunger holds the hands firmly.

590.310 Bergeon 30636-1 \$46.75



641.30637/2

BERGEON PRESTO #2 Cannon Pinion Remover

Removes all sizes easily, as well as hands on larger watches. Has sturdy jaws and side springs. Pusher blocks have long strokes.

641.30637/2 Bergeon 30637-2 \$56.95



641.30638/3
641.4079/3A*

BERGEON PRESTO #3 Sweep Wheel Removers

Designed to remove the smallest sweep wheels, as well as large sweep wheels. Three-pronged jaws will fit uneven number of spokes.

641.30638/3 Bergeon 30638-3 For five spoke wheels \$54.50

641.4079/3A* Bergeon 4079-3A For six spoke wheels \$57.25



641.30669/4

BERGEON PRESTO #4 Clock Hand Remover

Revolving turret, with four plungers of different diameters, supports the center post. Removes stubborn hands on gauges and meters, as well as those on watches and clocks, and the tool will not touch the dial.

641.30669/4 Bergeon 30669-4 \$62.95



640.30671.7

BERGEON PRESTO #7 Hand Remover

Turret with four plungers uses center post as support to remove hands without touching the dial. Very useful for movements without dials, stop watches and curved dials. Swiss made.

640.30671.7 Bergeon 30671-7 \$64.95



641.4344/9

BERGEON PRESTO #9 Crown Remover

For Split Stems. Will not damage tube or mar case. Exerts an even pressure on the crown and case to lift the crown straight off without snapping. Also for removing hands and setting knobs on travel alarms and desk clocks.

641.4344/9 Bergeon 4344-9 \$53.50



591.0345

Hand Remover

Fiber tips will not mar the dial. Sturdy jaws retract when side springs are pressed. Center plunger holds the hands firmly.

591.0345 \$16.35



591.0346

Cannon Pinion Remover

Removes all sizes easily. With sturdy jaws and side springs.

591.0346 \$12.75



590.698

Hand Remover

Quality hand remover, made in China..

590.698 \$17.95

Screw-on Pusher Crown Tool

Precision tool from Horotec features 12 pins for removing and inserting screw-on pusher crowns and tubes. Pins (or keys) easily snap into the non-roll handle. Includes a fitted stand to keep the tool in easy reach. Swiss made.

590.123 **\$208.95**

Chronograph Pusher Tool

Chronograph pusher tool for screwing in tubes of chrono pushers. 3.6mm. Horotec, Swiss made.

590.784.36 **\$47.00**



640.30610/100

BERGEON Barrel Arbor Holder

Slide locking jaws are specially designed to hold barrel arbors. 1.00, 1.50 or 2.50mm diameter opening.

640.30610/100 Bergeon 30610/1.00 **\$66.95**

640.30610.125 Bergeon 30610/1.25 **\$66.95**

640.30610/150 Bergeon 30610/1.50 **\$62.95**

640.30610.175* Bergeon 30610/1.75 **\$66.95**

640.30610.250 Bergeon 30610/2.50 **\$66.95**

Chronograph Button Tool

Sets and removes most standard 4.0mm buttons.

590.341 **\$41.95**

BERGEON Crown Winders

Plunger opens and closes jaws. Strong spring action holds crown firm while winding. Saves wear and tear on fingers. Swiss made genuine Bergeon 30409(A-D) or Economy (India) models.

641.30409D 2-4mm Ex-Small **\$41.95**

641.30409A 3-5mm Small **\$41.95**

641.30409C 4-6mm Medium **\$41.95**

641.30409B 5-7mm Large **\$41.95**

590.629 3-5mm Economy **\$8.75**

Chronograph Pusher Tools

For screwing in tubes of chronograph pushers. In two sizes: 3.0 and 3.5. Hollow handles for parts storage.

590.782 3.0 **\$47.00**

590.783 3.5 **\$47.00**

Genuine BERGEON Broken Screw Remover

Quickly removes broken plate screws. Deep U-shape permits inserting pocket watches as well as bracelet watches. Complete with four sizes of extra fine cutting jaws. Cutters are placed into head, held firm with set screws and brought to bear on broken screws. One end of head turns, causing the cutting action.

641.30209 Bergeon 30209 Screw Remover **\$118.95**

641.30209-A Replacement Broach 0.4 x 0.5mm **\$14.95**

641.30209-B Replacement Broach 0.6 x 0.7mm **\$15.75**

641.30209-C Replacement Broach 0.8 x 1.0mm **\$15.95**

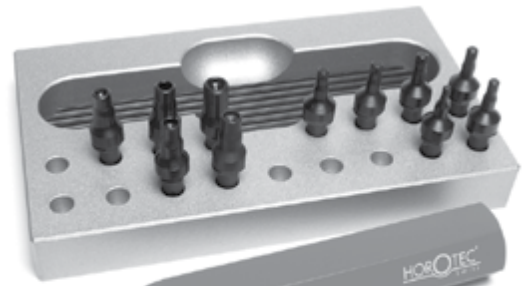

590.123

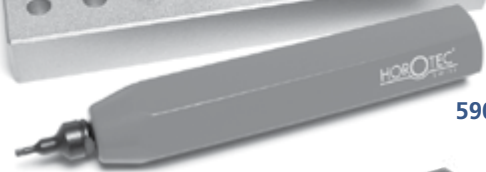

590.784.36



590.341



641.30409A



590.782
590.783



641.30209

BERGEON



640.2802.LE

Genuine BERGEON Poising Tool

Precision tool with 15mm ruby jeweled jaws and spirit level. Legs adjust so tool can be leveled. Jaws on 640.2802.LE has 3 notches.

640.2802.LE **\$499.00**



590.871

Omega Opener won't mar valuable watch cases

This genuine Omega tool is ideal for opening all high grade watches with snap back cases. Built-in nylon cylinder provides a rolling pressure point that won't mar valuable watch cases. Swiss.

590.871

\$115.00



590.101

Balance Screw Regulator for Omega

Specifically made for setting the micro-star shaped balance wheel screws on Omega calibre 2500B with movement inside the watch case. Instructions included.

590.101

\$94.50



640.1897



BERGEON

Bergeon Double-Ended Jewel Setting Polishers

Set of six rollers for polishing watch jewel settings. Set includes twelve different roller diameters: 1.80/2.10, 2.50/2.80, 3.00/3.30, 3.50/3.80, 4.00/4.30 and 4.50/5.00. Swiss made, Bergeon 1897.

640.1897

\$104.95



461.039A

Mainspring Coiling Pliers

One round stepped jaw and one concave jaw allows smooth looping. Jaws are smooth polished for coiling wire and inside coils of watch mainsprings when adjusting or forming to fit the barrel arbor. Lightweight design. 4³/₄" long.

461.039A

\$21.05



641.4733

Genuine Bergeon 4733 Cannon Pinion Tightener

Exceptionally fine jaws, carefully shaped, permit easy entry to pipe of cannon pinion for minute adjustments. Adjustments can be made to exact degree by means of screw below head.

641.4733

\$117.95



641.30433

Genuine Bergeon Pallet Fork Holder

For holding pallets when replacing or refinishing stones or arbors. Prevents loss of parts or inaccurate settings due to unsteadiness in holding pallets. Swiss made, Bergeon 30433.

641.30433

\$53.50

Swiss Oscillating Weight Tool

Specially made for releasing and locking the oscillating weight bolt of calibers 7750, 2872 and 2892. High quality Swiss made tool has a solid aluminum handle with two interchangeable pump-pushers for the bolts. Swiss made by Horotec.

590.093	Oscillating Weight Tool	\$112.95
590.093B	Replacement 2892 Pusher	\$40.75



Genuine BERGEON 6821 Oscillating Weight Tool

Precision tool from Bergeon specifically made to release and lock the bolt of oscillating weights. Simply place tool into bolt notches and twist 1/4 turn. Heavy non-roll handle. Swiss made. Fits ETA 2891, 2892, 2893, 2894, Chrono 2895 and Qtz Perpetual.

640.6821		\$169.95
-----------------	--	-----------------



Stem Shortening Tool

Tool for shortening winding stems. Knurled handle, features a stop for regular cutting. Horotec, made in Switzerland.

590.995	0.90mm / Tap10	\$49.95
590.997	0.80mm / Tap11	\$49.95



Genuine BERGEON ETACHron Keys

Special tools required for ETACHron mechanical movement repair. One tool is the Adjustment Key for adjusting regulating pins. The forked tool is the Extractor Key for removing the stud block. 2 1/4" long. Swiss made.

640.6918	Bergeon 6918 Adjustment Key	\$40.95
640.6919	Bergeon 6919 Extractor Key	\$40.95



Tools for Incabloc Novodiac Springs

Special tools for Incabloc's Novodiac springs used in ETA movements. Swiss made.

590.321	Tool for ETA 2801 Movement	\$66.95
590.322	Tool for ETA 2671 Movement	\$62.95

640.6918
640.6919

590.321

590.322

Tweezers for incabloc® Shock Absorbers

Special "genuine incabloc® original" Tweeze for holding incabloc shock absorbers. INOX Swiss made.

590.320		\$103.95
----------------	--	-----------------



590.320



641.5896

Genuine BERGEON Jeweled Pivot Caliper

Permits complete visibility of collet and provides room for adjustment of inner coil or hairspring. Balance is free to be spun or corrected with spring arc.

641.5896

\$85.95



640.30548

Genuine BERGEON Truing Caliper

Perfectly finished "Lyre" shaped truing caliper with ruby pivot protectors. Hole diameters 0.15mm. Wood handle. Swiss made.

640.30548

\$199.00



640.1884*

Genuine BERGEON Truing Caliper

Large calipers with pivot protectors have parallel opening.

640.1884*

\$167.95



590.400

Genuine BERGEON Truing Caliper

Small lightweight steel caliper for balance truing.

590.400

\$59.95



280.460

Carbide Rod for Making Poising Drills

Round carbide rod can be shaped into poising drills. Exceptional hardness, not easily breakable and it won't dull. 1½" x 1/32".

280.460

\$16.95



590.895

KIF Trior Shock-Absorber Tools

Set of 3 Swiss tools for assembling or dismantling KIF Trior shock-absorbers. With three tubes of 5 springs.

590.895

\$47.50



641.4852

Genuine BERGEON VYDIA X Roller Remover

Varying sizes of holes in the head of the tweezers securely grip the roller. Lets you turn balance to release it from the staff. Swiss.

641.4852

\$76.95



590.342

Roller Removers

V-slot slips between hub of staff and seat of roller. Slight pressure on sides of tool is sufficient to lift roller from balance seat. Extra fine jaws permit use on both small and standard sizes.

590.342 Bergeon 2810, Swiss

\$27.25

590.343 Economy, India

\$5.50

Tools for Rolex Repair

Inserting Tools for New Style Rolex Case Tubes

These are nicely finished hard steel tools.

590.817	for 5.3mm (length)	\$38.50
590.816	for 6.0mm (length)	\$38.50
590.819	Both Tube Tools	\$67.50

Inserting Tools for Old Style Fluted Rolex Case Tubes

Will not leave marks on tube like a broach does. 1 1/2" long.

590.875	for 5.3mm	\$41.95
590.876	for 6.0mm	\$41.95
590.877	Both Tube Tools	\$74.95

Case Tube Taps

For cleaning and truing case threads before installing new tubes.

590.821	2.5 x 0.25mm for 5.3mm	\$38.50
590.822	3.0 x 0.35mm for 6.0mm	\$38.50
590.823	Both Tube Tap Tools	\$67.50

Staking Tools for Auto Weight Axles

590.1530		\$29.95
590.2135		\$29.95
590.2235		\$29.95
590.3035		\$29.95
590.2599	Set of all Four	\$99.00

Regulating Wrench

For regulating Rolex watches has solid brass tip. 2 5/16" long.

590.814		\$27.50
----------------	--	----------------

Complete Set - Save over \$100.00!

Complete Tool Set for Rolex includes all eleven tools.

	Total Set Value	\$385.20
590.800	Complete Set	\$275.00

Cas-Ker is independent of, not affiliated with or sponsored by Rolex Watch USA



BERGEON Unbreakable Mainsprings Winder Set

Unbreakable mainsprings require a specially designed barrel arbor hook not found on conventional winders.

641.2795*	Set of 17 sizes 3 ³ /4 l to 24 l	\$889.00
641.2729*	Set of 7 sizes 3 ³ /4 l to 12 l	\$864.00

BERGEON Mainspring Winders

Drum with Arbor for ETA 2824, 2892, Valjoux 7750 and Nivaflex. Use with Handle #640.30082.M.

640.2729.05	Bergeon 2729-ETA-05 for ETA 2824	\$83.95
640.2729.07	Bergeon 2729-ETA-07 for ETA 2892	\$83.95
640.2729.09	Bergeon 2729-ETA-09 for Valjoux 7750	\$83.95
640.2729T	Bergeon 2729-T05 for Nivaflex No.5, 8.6mm	\$49.95
640.2729TG	Bergeon 2729-T09 for Nivaflex No.9, 13.0mm	\$49.95

BERGEON Handle for Mainspring Winders

Cylindrical brass handle holds your drum and arbor while winding a mainspring. The plunger then releases the barrel with spring from the winder. For right hand winders. (Winder not included.) Bergeon 30082-M

640.30082.M		\$52.50
--------------------	--	----------------





BERGEON

640.2229-03

Genuine Bergeon Escapement Tester 2229-03

The Bergeon 2229-03 apparatus allows for very precise adjustment of watch pallet stones length.

Features: Pallets are gripped by a spring lever and the lifting adjustment is done by use of a knurled knob. The stainless steel support plate for pallets also has two centrings to adapt the diameter of the pallet staff. Dial with hands graduated in 0.01mm. Dimensions: 45 x 90 x 27mm (1¾" x 3½" x 1").

Operating temperature 130°C(266°F). May be used in conjunction with a Bergeon fixed temperature heater 30460.

640.2229-03

\$995.00

Electric Heater for Escapement Tester Bergeon 30460-VAR-115

The Bergeon 30460 with adjustable ambient temperature up to 160°C (325°F) with the help of a potentiometer. Can be used for pallet stones, preparing gaskets for fitting mineral glasses, drying, etc. Plastic insulated frame and smooth aluminum working surface. 115 volt.

640.30460.VI

\$485.00



640.30460.VI

HORIA

Horia Jeweling Tool

A superior Swiss made jewelers tool with micrometric screw for installing friction jewels and for rectifying endshake. Used with the Horia pusher and anvil set, the micrometer adjustment lets you control the movement of the pusher very precisely. Consistent adjustments are easy and repeatable. It can also be used for removing and installing pallet staffs and adjusting tension on traditional style cannon pinions.

- Opening 25mm
- Total height 120mm
- Base 80 x 45mm
- Table hole: Ø 4.00mm
- Spindle hole: Ø 4.00mm

640.0614

\$519.95

640.0614



640.5374.B4

Horia Pump Pushers & Anvils for jewelry tool

Swiss made assortment of twelve 4.00mm diameter pump pushers and six anvils (or stumps) for different sizes of jewels or bushings.

640.5374.B4

\$472.50



590.035

Jewelry Punch & Stake Set for Incabloc®

This Swiss made assortment is specially adapted for the different sizes of Incabloc® shock-absorbers. The punches and stakes should be chosen according to the relations of size in supporting surfaces. Instructions are included that clearly illustrate these relations. Set includes 6 Punches sizes 1.57, 1.87, 2.07, 2.47, 2.97, 3.47, and 7 Stakes sizes 1.65, 2.00, 2.30, 2.50, 3.00, 3.50, 4.00. For use with jewelry tool for 4mm posts.

590.035

\$83.95

BERGEON 3007 Collet Tool

Comes with seven different notches for tightening all sizes of collets. Swiss made.

641.3007 **\$137.95**

Bergeon Support for Impulse Pin

Support for cleaning the impulse of a balance. Bergeon 7990. Swiss made.

640.7990 **\$16.50**

Balance Tack

Simple but practical for holding bridge with balance attached while putting it in beat, straightening kinks in hairsprings, undercutting screws, adding or removing timing washers, etc.

591.0310 **\$10.55**

Micro-Stella Wrench

Provides super precision to properly regulate the Rolex™ balance.

590.117 **\$41.95**

Adhesive Cleaning Swab

Bergeon's adhesive cleaning swabs are 70mm long and have a 2 or 3 mm polyurethane head. Washable and reusable, one swab can last three weeks to three months, depending on usage. Pick up watch hands or other small parts without touching or tweezers to avoid prints, smudges, or damage.

640.7007.22 3.2 mm **\$5.95**

640.7007.23 2 mm **\$2.95**

Cleaning Pad

Stick cleaner collects impurities from self-adhesive swabs 640.7007.22, 640.7007.23 (above), and other adhesive swabs. Clean and activate this product with isopropyl alcohol, or use Bergeon cleaning wipes, product 640.7040 (see page 20).

640.7007.C **\$29.95**

Barrel Closing Tool

This tool allows easy barrel cover fitting. Bergeon 7922.

640.7922 **\$27.95**

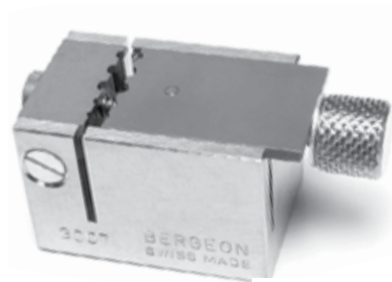

641.3007



640.7990



591.0310



590.117



640.7007.22
640.7007.23
640.7007.C



640.7922



800.221

Zantech Conductive Epoxy

Wire-bond .001 is a two part silver filled, electrically conductive epoxy. Repair circuit boards, coils and motor wires of electronic watches. No heat or special tools required. Hardens at room temperature in 24 hours. Includes epoxy syringes, ceramic plate and spatula.

800.221 Epoxy Kit **\$67.95**

800.222 Epoxy Refills **\$59.75**



800.220

Circuit Works repairs circuits as easily as writing

Draw fine line, conductive silver traces, jumpers and shielding, as easily as writing. Link components, repair defective traces, makes smooth jumpers; solder mask, copper and gold. Conductive material is silver filled with assay of 50 to 60% metal content.

- Makes instant silver conductive traces on most rigid and flexible surfaces.
- Use where conductive electronic traces are needed.
- Dries fast at room temperature.
- Self-cleaning tip for easy application.
- Solderable at below 350°F.

800.220 **\$62.95**



591.0890

VIGOR® Circuit Maker

Repairs quartz analog and digital circuitry as well as any other fine wire circuits with a minimum of time and effort. Eliminates long drying times. One minute set up time required. Kit includes .05 fluid oz. bottle of Circuit Maker® and an applicator.

591.0890 **\$33.10**



900.025

Movement Spacers

Assortments of plastic movement holders for retro-fitting movements. Swiss made.

900.025 25 Rings Asst Sizes **\$16.95**

999.625.07 10 Rings for 7³/₄ ligne **\$7.95**

999.625.08 10 Rings for 8³/₄ ligne **\$7.95**



650.001

SPEEDI-FIT Watch Case Filler

Speed-Fit is used to fill voids in cases when retrofitting quartz movements. Base and catalyst are putty-like materials which cure in 5 to 7 minutes to a flexible substance that can easily be trimmed with a knife. The mixed material is pushed into a case back and a scrap movement is pushed into place where the new movement will fit. Kit includes 50 grams each of base and catalyst, and instructions. Provides enough material for 15 to 25 movements.

650.001 **\$39.95**



910.041

910.042

Dial Dots and Strips

Self adhesive Dots 3mm, or Strips 12x2mm for attaching dials to movements.

910.041 60 Dots **\$4.95**

910.042 100 Strips **\$5.95**



590.292

Movement Gauge

Gauge measures in lignes, millimeters and American movement sizes.

590.292 **\$4.50**

Make curved spring bars from straight ones in seconds

Smooth operating tool makes easy work of bending spring bars to fit curved bracelets. Two slots accommodate all sizes of spring bars. Fine finish and construction as do all Horotec tools. 4" long base takes up very little space and may be bench mounted. Swiss. **590.947** **\$145.50**



590.947

Genuine BERGEON Spring Bar Tool with Reversible Tips

The ultimate tool for fitting and removing spring bars. Nickel plated with knurled grip. One end is a 4mm spatula-shaped fork and the other is a reversible pin pusher and small 0.80mm fork. 5 1/2" long. Swiss made.

640.6111	Spring Bar Tool Bergeon 6111	\$44.95
640.6111.E	Replacement Spatula Fork	\$5.50
640.6111.D	Replacement Pin Pusher/Small Fork	\$5.50



640.6111

640.6111.D

640.6111.E

BERGEON

Genuine BERGEON Spring Bar Tool

Solid well balanced Swiss made tool. One end is straight and the other is forked. Comfortable thin shape with knurls for a sure grip.

590.684	Bergeon 6767-F Spring Bar Tool	\$16.25
590.692	Straight Pin	\$1.95
590.693	Forked Pin	\$3.75



590.684

Genuine BERGEON Pin Pusher with Gauge

Bakelite spring bar tool has a non-roll hexagon shape. One straight end and one forked. Millimeter and inch gauges for measuring between lugs. An economy model is also available.

590.302	Bergeon 3153 Spring Bar Tool	\$21.95
590.012	Economy Tool made in India	\$4.25
590.303	Replacement Fork End	\$3.25
590.304	Replacement Straight Pin End	\$1.95



590.302
590.012

Swiss Pin Tool with Sharp Points

Unique forked end with curved sharp points for hard-to-reach spring bars. Straight for through holes. Replaceable points screw into knurled handle. 4 1/4" overall with millimeter gauge. Swiss.

590.068	Spring Bar Tool	\$15.25
590.071	Replacement Fork End	\$4.95



590.068

Tool with Reversible Pins

Each with a forked end and a straight end 5 1/4" long. France.

590.485	Spring Bar Tool	\$10.50
590.486	Pins	\$2.95 ea



590.485

Swiss Bracelet Pin Tool with two styles of tips

This tool has a 1.45mm angled square tip for prying the flange of a spring bar and a 0.75mm round tip for pushing pins and spring bars. 5 1/4" long with knurled handle. Swiss made.

590.028	Bracelet Tool	\$22.95
590.031	Replacement Square Pin	\$6.25
590.032	Replacement Round Pin	\$3.25



590.028

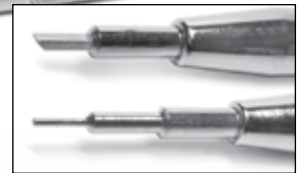

Spring Bar Tool by Bergeon, 6767-S

Tool for fitting and removing spring bars with standard points and forks. 3mm fork and 0.8mm pointed ends, with stainless steel handle. 5 3/4"

640.6767.S		\$16.95
-------------------	--	----------------



590.028



590.300

590.230

590.364

590.679

590.015

590.180

590.189

590.121

590.580

Spring Bar Tools & Pin Pushers

Wood Handle Pin Pusher

For removing spring bars. Tempered steel blade can also be sharpened to scratch designs on soft metals. 5" long.

590.300 **\$6.90**

Tool with Shaped Wood Handle

This Pin Pusher gives you better control on stubborn bracelet pins. The best hardened tool steel of any pin pusher on the market. Hardwood handle. Tip is slightly flat to prevent slipping, and shaped handle may be held like a pen.

590.230 **\$5.50**

Pin Pusher

Pin Pusher has one pointed end and one notched end for blind holes. 4 1/2" long.

590.364 **\$1.75 ea 3 @ \$1.50 ea**

Mini Pin Pusher

Only 2 5/8" long with a sharp point, smooth rounded head. India.

590.679 **\$1.80**

Heavy Mini Pin Tool

Knurled handle for firm grip. One pointed and one forked tip. 3"

590.015 **\$3.25 ea 3 @ \$2.95 ea**

Set of 3 Short Pin Punches

Use these to get a pin started when removing from a watch bracelet. Finish up with the longer pins (below). Knurled handles and set screws. Diameters: .70, .80 & 1.0mm, 1 7/8" long overall.

590.180 Short Pin Punch Set of 3 **\$16.50**

590.181 Replacement Pin 0.70mm **\$3.25/3**

590.182 Replacement Pin 0.80mm **\$3.25/3**

590.183 Replacement Pin 1.00mm **\$3.25/3**

590.193 Set-Screws for 590.180 & 590.189 **\$3.25/3**

Set of 3 Standard Pin Punches

Handy for removing watchband pins. Knurled handles and set screws. Set of three sizes, 2 1/8" long.

590.189 Set of 3 Pin Tools **\$15.70**

590.190 Replacement Pin 0.70mm **\$3.25/3**

590.191 Replacement Pin 0.80mm **\$3.25/3**

590.192 Replacement Pin 1.00mm **\$3.25/3**

590.193 Set-Screws for 590.189 & 590.180 **\$3.25/3**

Bracelet Pin Pusher with Aluminum Handle

This handy tool comes with two each of three sizes of pins; 0.70, 0.80 and 1.00mm. Pins are held firmly with a set screw. Lightweight anodized aluminum knurled handle is 4" long.

590.121 Pin Pusher **\$8.75**

590.121.1 Set of Six (2 each size) Replacement Pins **\$3.25**

Pin Pusher Set with 10 Pins

This link pin remover set comes complete with 10 pins in sizes: 0.40, 0.60, 0.70, 0.80, 0.90, 1.00, 1.10, 1.20, 1.50 and 2.00mm. Pins are easily interchangeable in the tension fit handle. Set is packaged in a premium wood box with magnetic closure.

590.580 **\$14.75**

590.580.01 Set of 16 Replacement Pins **\$9.95**

Screw Type Pin Tool

Easily remove pins in bracelets up to 19mm wide. Large knurled knob. Replaceable pin is held with set screw. Extra pin and screwdriver included. India.

590.673 Pin Tool	\$11.95
590.592 Extra Pins pack	\$1.00/2



590.673

Bracelet Pin Remover

This pin tool makes easy work of removing pins from band links with a simple twist of the knurled handle. Anodized aluminum with steel pin. Adjusts for different band thicknesses. 0.80mm Pin, 3 1/8" long overall.

590.081 Link Remover	\$9.95
590.085 Extra Steel Pins 0.80mm Pack of 2	\$2.95/2



590.081

Bracelet Pin Remover

Easily remove pins in bracelets with this tool. Simply twist the handle to drive pins out quickly. Base is adjustable to accommodate different band thicknesses. Plastic base with steel shaft.

590.082 Pin Remover	\$8.75
590.083 Spare Pin	\$1.50



590.082

Pin-Linked Bracelet Tool

For adjusting pin linked watch bracelets. Piston is pushed by the palm of the hand allowing quick insertion and removal of pins. 7 1/2" long. India. Tool w/ 2 pins.

590.630 Pin Tool	\$3.95
590.633 Replacement Pin	\$4.25



590.630

Easy to Use Link Remover

Essential for removing pins from metal link watch bands. Made of glass-filled nylon, unit includes an extra spacer for thinner bracelets. Pusher pin is hardened tool steel. Will not scratch or mar gold or silver. Provides years of service.

590.118 Nylon Pin Remover	\$15.95
590.119 Pins for 590.118	\$3.15
590.114 Plastic Pin Remover	\$6.50
590.115 Short Pins for 590.114	\$1.80/2
590.116 Long Pins for 590.114	\$1.80/2



590.118

Citizen Link Pin Remover

Easy to use plastic pin pusher for watch bracelets. Steel shaft and push pins, with 2 extra pins.

590.038 Pin Remover	\$14.75
590.039 3 Pins	\$7.25



590.038



590.312



590.064



590.315



590.317



590.316



590.311



590.663



590.635

Watchband Pin Tools

Swiss made Watch Bracelet Vice

Remove and replace pins easily with this handy vise from Horotec. Made of very hard plastic to give you a firm hold on bracelets without marring. Large knurled adjustment screw.

590.312 **\$29.75**

Swiss made Bracelet Vice for Large Watches

This solid vice is made of very hard plastic to give you a firm hold on larger bracelets without marring. Smooth operating with large knurled adjustment screw.

590.064 **\$42.95**

Watch Bracelet Vice

Hard solid plastic base adjusts with a turn of the large knurled screw. Holds any thickness of band firmly so pin can be removed with a pusher. Safe, non-marring.

590.317 **\$9.95**

Citizen Band Vice

Sturdy hard plastic vise holds bands of any thickness firmly so pin can be removed with pusher.

590.315 Vise **\$39.95**

590.316 Pin Pusher **\$8.50**

Mini Vice holds bracelets safely

This efficient tool holds watch bracelets while you remove pins for resizing. Plastic vise with weighted base won't mar valuable bands. Large knurled knob for easy control. Includes 0.7/7mm and 0.7/14mm pin tools plus 5 spare pins each.

590.311 **\$24.95**

Tool for Gucci style screw lugs

This small tool is simple but extremely handy for replacing Gucci style lug screws. One small screwdriver is held in position by a set screw and the other is free to turn the lug. Base is only in 1 1/4" diameter.

590.663 **\$7.75**

Swiss Tool for Fitting Gucci Bands

This tool is perfect for removing or replacing the screw that attach Gucci bands to the case. Includes two extra blades. Swiss.

590.635 **\$34.95**

Genuine BERGEON Bracelet Pin Pliers

Metafil pliers are an effective tool used for inserting, removing and reinserting pins for all types of metal bands. Plastic support prevents damage to band during handling. Using the set of shims provided, you can adjust the pliers to the size of the band. Includes two pin removing plungers 0.75mm and 0.85mm diameters and an inserting plunger. Instructions included. Swiss.

640.6819	Bergeon 6819 Bracelet Pin Plier	\$207.95
640.6819.75	Bergeon 6819-1-6 DI 0.75 Pin 0.75mm	\$16.75
640.6819.85	Bergeon 6819-1-6 DI 0.85 Pin 0.85mm	\$16.75
640.6819.1.75	Bergeon 6819-1 DI 0.75 Plunger 0.75mm	\$27.25
640.6819.1.85	Bergeon 6819-1 DI 0.85 Plunger 0.85mm	\$27.25
640.6819.2	Bergeon 6819-2 Plunger	\$19.95
640.6819.3.1	Bergeon 6819-3 No.1, 11mm Shim	\$5.25
640.6819.3.2	Bergeon 6819-3 No.2, 8mm Shim	\$5.25
640.6819.3.3	Bergeon 6819-3 No.3, 5mm Shim	\$5.25
640.6819.3.4	Bergeon 6819-3 No.4, 4/5mm Shim	\$5.25



640.6819

Bracelet Pin Plier with Adjustable Holder

Features an adjustable holder to accommodate bracelets up to 40mm wide. The sliding stop also provides a secure hold on bracelets while removing pins. This one tool helps you size watch bracelets without the old "hammer and chisel" routine. Remove and replace pins without marring the bracelet or your fingers. Supplied with 0.80mm and 1.00mm pin pushers.

461.001	Bracelet Pin Plier	\$29.95
461.001.5	Punch Point 0.80mm	\$3.95
461.001.1	Punch Point 1.00mm	\$3.95
461.001.4	Pins only 0.80mm (for older model only)	\$4.75
461.001.2	Pins only 1.00mm (for older model only)	\$4.75
461.001.3	Spring only	\$3.25



461.001

461.001.1

461.001.5

Genuine BERGEON Bracelet Pin/Spring Bar Driver

Metal frame with plastic handles drives out watch bracelet pins and removes spring bars. Interchangeable broaches, adjustable in hardened steel. 4 7/8" x 2 3/4". Swiss.

590.676	Bergeon 6578 Pin Driver	\$107.95
Extra Pins		
590.677/.70	Bergeon 6578G/.70 0.70 Friction	\$4.95
590.677/.90	Bergeon 6578G/.90 0.90 Friction	\$4.95
590.677/1.15	Bergeon 6578G/1.15 1.15 Friction	\$4.95
590.678	Bergeon 6578F 0.80 0.80 Threaded	\$4.95



590.676

Bracelet Tool

Save time with this handy tool for removal and fitting of metal bracelet links and screw-type case bars. Ideal for use by unskilled personnel in shops as well as professional watchmakers. Features three replaceable popular size blades 1.00, 1.40 and 3.00mm mounted on a non-slip aluminum stand. 40 x 20 x 25mm. Swiss.

590.285		\$15.75
----------------	--	----------------



590.285

Pin Removing Kit

The most practical tool made for removing friction pins from watch bracelets. The grooved wood block holds bracelet steady so you can hold the punch and tap it lightly with the small hammer provided. Steel pins 1.00mm & 0.8mm replaceable by set screws.

590.671	Complete Kit	\$19.25
590.672	Wood Block	\$8.75
590.671-0.80	Pin Holder w/Pin 0.80mm	\$4.95
590.671-1.00	Pin Holder w/Pin 1.00mm	\$4.95
590.671.80	Pin only 0.80mm	\$1.95/2
590.671.100	Pin only 1.00mm	\$1.95/2



590.671

Pins and blades with wing system provide fast and precise setting

BERGEON

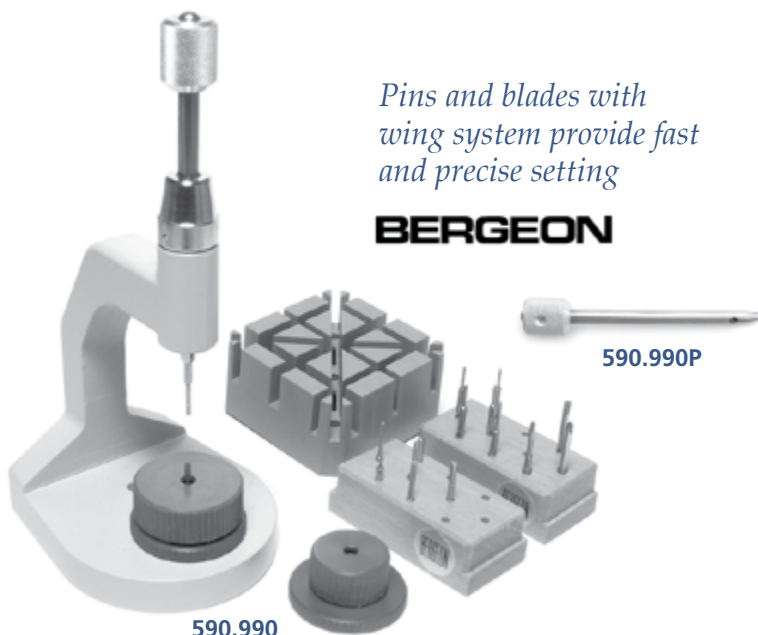

590.990

590.990P

Genuine BERGEON Ultimate Press gives you the best position on bands

This multi-use tool from Bergeon lets you drive watchband pins and screws in and out with ease. The sturdy base maintains a good support for leather and metal bands, and the two holders allow adjustment for all sizes of bands. Includes Base, Broach with drum, 2 Holders with adjustable height, Set of 10 Blades on wooden stand, and Set of 6 Pins on wooden stand. Swiss made.

590.990	Bergeon 6745-100 Band Press	\$312.95
590.990P	Pin Holder with Drum	\$21.95
590.991	Set of 10 Blades on Wooden Stand	\$39.95
590.992	Set of 6 Pins on Wooden Stand	\$25.95
590.686 thru 590.691	Pins only	\$3.25 ea

BERGEON Pin Removing Kit

Drive bracelet pins easily with more control. Set of two bases allows you to get a good position on watch bracelets for removing and inserting pins. Set includes two plastic tooling bases with slot sizes 2.2, 2.6, 3.0, 3.4, 3.8, 4.0mm, six pins 0.40 - 2.00mm diameters, one pin holder. All on wood base. Swiss. Bergeon 6744.

590.674 \$87.95

Replacement Pins

590.686	.40mm	590.689	1.00mm	\$3.25
590.687	.60mm	590.690	1.50mm	\$3.25
590.688	.80mm	590.691	2.00mm	\$3.25
590.697	.90mm			\$3.15



590.674

Horotec Watch Bracelet Holder and Pins

Easily remove and fit bracelet pins. Kit includes plastic band block, hardwood base, six pins and pin holder. Swiss made.

590.001 \$52.50



590.001



590.675

Bracelet Holder

Securely hold bracelets for removing screws or pins. Four grooves of varying widths assure the perfect hold for every bracelet. India.

590.675 \$6.50

Holder for Thick Watch Bracelets

Plastic holder has slots of different widths for securing thick bracelets while you remove and install screws or pins. 2 1/8" sq.

590.319 \$19.50

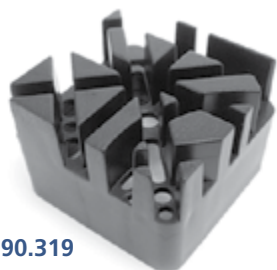

590.319

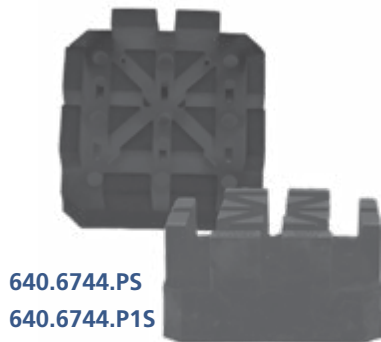

640.6744.PS

640.6744.P1S

Bracelet Holder

Bracelet holder made of soft synthetic material for standard or extra large sizes. Works great with items 590.674 and 590.990, above.

640.6744.PS	for Standard Sizes	\$13.95
640.6744.P1S	for Larger Sizes	\$14.95

Clasp Adjusting Tools for Rolex

Set of two tools specifically made to adjust Rolex Presidential clasps but will work on any style. 4 1/4" long.

590.545 **\$39.95**



590.545

Clip Spring Plier for Seiko Style Bracelets

Specifically made to remove clip springs from Seiko style watchbands. The flat forked jaw rests atop the link, and the pointed tip fits under the clip spring. Squeeze the handle and the spring pops up for easy removal. 5" long overall.

460.135 **\$18.95**

Expansion Band Clip Spring Plier

Perfect for removing clip springs in expandable bands. Flat jaw rests atop the link, pointed tip fits under the clip spring. By squeezing, the clip spring pops up and can be easily removed for sizing. 5" long. Cushion handles, box joint, return spring.



460.136 **\$11.95**



460.135

Spring Bar Bender

This plier has nylon jaws to make smooth curved spring bars out of straight ones. Box joint and cushioned handles.

460.103 **\$16.50**

460.103.1 Replacement Jaws **\$4.25**

460.136



460.103

Spring Loaded Pin Tool

Push on a bracelet pin with this tool, the shaft retracts and then snaps the pin through. Fast and easy. Knurled handle. 4 7/8" long.

590.084 **\$14.25**

590.084.1 Replacement Pin **\$1.95**

590.084



Clasp Saver Repair Tool

Clasp Saver tool repairs folding clasps without damaging them. Saves folding clasps by allowing them to click and lock again without having to replace them. Allows proper adjustment (bending) of the thick metal sections found on most folding clasps. Easy to use, long lasting and reliable. Saves money for you and your customers by repairing clasps instead of replacing them. Swiss made. Includes 6 dies.

590.637 **\$195.00**



590.637

BERGEON Ergonomic Pin Extractors

This genuine Bergeon Extractor Set includes five different color coded sizes: 70, 80, 90, 100 and 120, each with 3 extra pins in plastic tubes. Rubber grip knurled handles offer better control. And it all comes in a hinged lid wooden box. Swiss made.

640.6988 Set of Five Bergeon 6988 **\$197.95**

640.6988.70 Replacement Pin 0.70mm **\$1.75**

640.6988.80 Replacement Pin 0.80mm **\$1.75**

640.6988.90 Replacement Pin 0.90mm **\$1.75**

640.6988.100 Replacement Pin 1.00mm **\$1.75**

640.6988.120 Replacement Pin 1.20mm **\$1.75**

640.6988





590.017

590.002

Swiss made Multi-Purpose Bracelet Pin Press

This kit has everything you need for fitting metal bands. Swiss made by HOROTEC. Steel and aluminum punch holder, Six pins .40 thru 2.00mm and holder, Plastic band block and Screwdriver with 9 rapid change blades and nylon protector for removing lugs. Everything stores neatly on stand.

590.002 Complete Horotec Press **\$199.95**

Press also available with Punch and 6 Pins (without Screwdriver)

590.013 Press with Punch only **\$104.95**

590.011 Punch Holder only **\$29.50**

Economy Multi-Purpose Link Press

Unique tool removes and replaces stubborn friction pins, bracelet screws and Gucci type screws. Securely holds bracelets in alignment. Frame is solid steel except for non-scratch plastic bracelet holder. Includes pin sizes 0.40, 0.60, 0.80, 1.00, 1.50 and 2.00mm. Also includes a 2.50mm screwdriver. Made in India.

590.017 **\$32.95**

Replacement Pins

Swiss made for 590.002 & 590.017 **\$2.25 ea**

590.004 0.40mm **590.005** 0.60mm **590.006** 0.80mm

590.007 1.00mm **590.009** 1.50mm **590.010** 2.00mm



640.8745

B-PRESS
SWISS MADE

BERGEON Multifunction Press

Drives watch bracelet pins and screws in and out. Support lets you maintain a good position on watches with leather or metal bracelets. Made of composite material. Bergeon 8745. Contains: Support, Pin Holder with Drum, 2 Bases with adjustable height, Set of 10 Blades and 6 Pins.

640.8745 **\$164.95**

Multi-Function Press fits bracelet screws, hands and removes pins

Versatile Swiss press has all you need for fitting metal bracelets and watch hands. Base for movement holders such as our 590.682 series also has holes for bench mounting. Everything stores neatly on the stand. Includes; spring loaded punch/screwdriver tool, screwdriver blades; five 1.0mm and three each 1.2 and 1.6mm, three each pin pushers; 0.8 and 1.0mm, plastic bracelet support block, colored hard nylon hand press pins; 0.50, 0.80, 1.00mm and a concave pin.

590.029 **\$339.00**



590.029

Bracelet End Cutter

Ideal for shortening steel watch bands and other heavy cutting jobs. Hardened carbon steel with cutting edge adjustment. Short jaws for higher leverage and cutting power. Slide locks jaws in closed position. Pressed steel handles. 11/16" wide jaws. 8" long.

460.578 **\$54.95**



460.578

Accurate Bracelet Cutting Shear

The best shears made to cut mesh watchbands easily and accurately. Features a cylindrical tempered steel blade and 90 degree cutting head. Bands are cut at right angles and never fray or part. Built to last for years. Made in Italy.

460.199 **\$132.95**



460.199

6-in-1 Hole Punch Plier

Rotating punches make six different size holes; 2.0, 2.5, 3.0, 3.5, 4.0 and 4.5mm.

460.997 **\$13.50**

Strap Hole Punch

Ideal for adding holes to watchstraps. Black with comfortable cushion grip handles, spring return. Punches a 1.5mm hole.

460.998 **\$10.95**

Economy Hole Punch

Economy puncher is Ideal for adding holes in leather watchstraps. Punches a 2mm hole. 5¾", cushion grip handles. Made in India.

460.999 **\$7.95**



460.997



460.998



460.999



BERGEON

460.662



Genuine BERGEON 6620 Strap Notching Pliers
 First quality aluminum pliers cut shapes into leather straps. Supplied with one die, three half-round punches and three rectangular punches. Adjustable strap guide. Swiss made

460.662 **\$339.00**



460.816

Strap Notchers

Great for converting straps to fit Gucci, Swatch and other high fashion watches. Box joint. Spring loaded. Made in India

460.816 **\$10.95**

Hole Punch with Six Tips

Just position the tip on a leather watchstrap and push slowly. The tip "pops" through the strap, making a clean hole. Includes six different size punches. 5¼" long.

590.944 **\$9.95**



590.944

Use Pin Vises to hold a wide variety of items such as small drills, taps, wire, rod, screws, etc.

580.279



Single End Pin Vise

Holds small drills, taps, wire, rods, screws, etc. 3½" long, hollow metal handle and screw chuck. Capacity 0 to 1/16". India.

580.279 \$2.25 ea 3 @ \$2.00 ea

581.205



Brass Handle Pin Vise

Steel collet is set into hollow brass handle with screw chuck. Capacity 0 to .71 mm, overall length 3¹/₈".

581.205 \$7.40

581.231



Economical Wood Handle Pin Vises

Pin vises have black fluted wood handles and steel chucks.

581.231 Capacity 0-1.19 mm 4" long \$10.30

581.232 Capacity 0-1.5 mm 4½" long \$10.30

580.235



Pin Vise with Wood Handle

Knurled pin vise features a comfortable swivel wood handle.

Double ended steel chuck holds a variety of tools. 4" long.

580.235 \$4.95

581.250



Square Chuck Pin Vise

Two steel chucks, with spare chuck held in end of hollow brass handle. Will not roll off bench. Capacity 0 to 2.0 mm, length 3¾".

581.250 \$10.25

581.221



Swivel Head Pin Vise

Large free wheeling head, suitable for drilling, tapping, using as a screwdriver, etc. Two double-ended collets, one in screw chuck and the other stored in the handle. Capacity 0 to 3.2mm, 3½".

581.221 \$9.50

580.300



Sliding Pin Vise

Knurled ring slides forward to close steel jaws, making it easy to operate with one hand. Handle is hollow. Capacity 0 to 1.3 mm, overall length 4¹/₈". India.

580.300 \$4.25

640.30432



BERGEON Sliding Pin Vise

Slide locking pin vise. Steel jaws with 0 -1.5mm opening.

640.30432 \$20.95

581.200



Mini Pin Vise

Mini size, hollow handle metal pin vise with screw chuck.

Capacity 0 to .51 mm, overall length 1⁷/₈".

581.200 \$7.95

580.100



Double-End Pin Vise

Horotec pin vise has two identical size steel collets, capacity 1.3-3.5mm. Fluted nickel-plated handle and two round heads. 4¼".

580.100 \$11.50

BERGEON

Genuine BERGEON Pin Vise Set

Premium quality pin vises have round heads and hardened steel chucks. The four larger vises have two chucks each offering a total of nine different openings: 0.7, 0-1.5, 1-1.5, 1-1.5, 1.5-2, 2-2.5, 2.5-3, 3-3.5, and 3.5-4mm. Nicely finished knurled handles. All in a fitted wooden box. Swiss made BY Bergeon, 30026-A.

640.30026A **\$249.95**



640.30026A

Genuine BERGEON Pin Vises

Precision Swiss made pin vises include two hardened steel chucks (except 641.30021/1) available in five sizes. Premium quality finished with round head and knurled handle.

641.30021/1* Bergeon 30021-1 0.0-0.7mm **\$52.95**

641.30022/2* Bergeon 30022-2 0.0-1.0 & 1.0-1.5mm **\$48.95**

641.30023/3* Bergeon 30023-3 1.0-1.5 & 1.5-2.0mm **\$34.25**

641.30024/4 Bergeon 30024-4 2.0-2.5 & 2.5-3.0mm **\$39.95**

641.30025/5 Bergeon 30025-5 3.0-3.5 & 3.5-4.0mm **\$46.95**



641.30021/1-
641.30025/5



640.5860



640.1842.18A



640.1842.16A



581.240



581.215

Genuine BERGEON Pin Vise with Reversible Chucks

Two reversible chucks, 0-2.1/1.9-3 and 0-2.1/1.9-3 with round hole openings. 5" long. Bergeon #5860.

640.5860 **\$24.75**

Genuine BERGEON Small Pin Vise

Two chucks, 0-1.0 and 0.8-2.0 with square adjustment. 3³/₈" long.

640.1842.18A **\$13.95**

Genuine BERGEON Large Pin Vise

Two chucks, 0-1.5 and 2.5-4.0 with square adjustment. 5" long.

640.1842.16A **\$17.95**

Double-Ended Pin Vise

Steel collets in each end. Hexagonal heads prevent rolling. Hollow handle, heads made of brass. Capacity is 0 - 3.2 mm, overall 4¹/₈".

581.240 **\$8.25**

Double-Ended Pin Vises

Different size steel collets are mounted in both ends of hollow handle. Capacity 0 to 2.5 mm, overall length 4¹/₄".

581.215 **\$10.55**

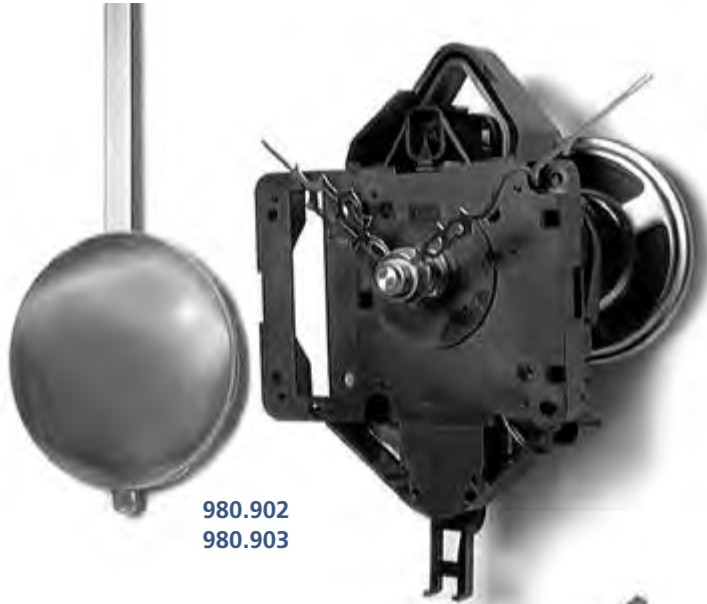

980.902
980.903

Dual Chime Pendulum Movement, Westminster and Whittington Chimes

This quartz dual chime movement is a compact unit with all of these capabilities:

- Westminster & Whittington Chimes.
- Counts the hours on the hour, sounds half and quarter hours.
- Uses a C size battery, not included.
- Second hand, if used, advances at one second intervals.
- Hour and minute hands included. *Select hands from page 122.*
- Movement Size: 4 $\frac{3}{8}$ " x 3 $\frac{3}{4}$ " x 1 $\frac{3}{4}$ ".
- Center post diameter 5/16".
- Adjustable Pendulum, 2 $\frac{3}{4}$ " diam. bob.
- Automatic night time silence.
- Removable speaker includes bracket.
- Five Year Guarantee.

980.902 for Dials 1/4" Thick **\$43.95**

980.903 for Dials 3/4" Thick **\$43.95**



980.909
980.910

Dual Chime Westminster & Whittington - No Pendulum

Quartz dual chime movement features:

- Westminster/Whittington Chimes. Counts the hours on the hour, sounds the half and quarter hours.
- Hour and minute hands included. *Select hands from page 122.*
- Second hand, if used, advances at one second intervals.
- Operates on one alkaline C size battery, not included.
- Movement Size: 4"H x 3 $\frac{1}{2}$ "W x 1 $\frac{1}{8}$ "D.
- Center post diameter 5/16".
- Night time silence and volume control.
- Available in 2 center post lengths.
- Quantity prices available.
- No Pendulum.

980.909 for Dials up to 5/16" **\$36.75**

980.910 for Dials up to 3/4" **\$36.75**



980.892
980.893

ThinLine Pendulum for Smaller Clocks

The free swinging adjustable pendulum is an appearance item independent of the quartz clock, actuated by electro-magnetic driving force. It is not subject to stoppage due to slight variation from plumb as are mechanically actuated pendulums.

- Rear Setting.
- Accurate within 10 seconds per month.
- Operates over a year on one AA alkaline battery, not included.
- Compact Size: 3 $\frac{1}{4}$ "H x 2 $\frac{1}{4}$ "W x 7/8"D.
- Center post diameter 5/16".

980.892 for Dials up to 1/4" thick **\$16.75**

980.893 for Dials up to 5/8" thick **\$16.75**

Brass Mechanical Clock Movement

Brass mechanical clock movement with 4½" drop. Includes key and hands. Plates measure 5¾"H x 3¾" W (6½"H x 6½"W including mounts and wheels). Made in India.

980.201 \$49.95



Brass Mechanical Clock Movement

Brass 8 Day mechanical clock movement with 9½" drop. Includes key and hands. Plates measure 3¾"H (5"H x 3¾"W including mounts and wheels). Made in India.

980.202 \$59.95

980.201
980.202

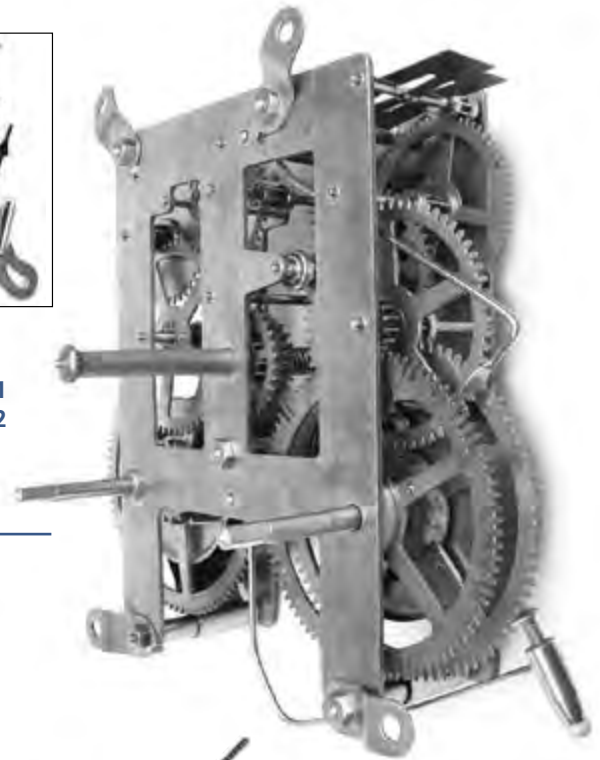

Hour and Minute hands included with all quartz clock movements. Select hands from page 122.

Quantity pricing available. Call for details.

Premium Quartz Mini Clock Movements

Made in Japan by the world's largest producer of quartz timepieces, our Mini Movement offers you the highest reliability, and the lowest prices.

- Accurate within 10 seconds/month.
- Extremely quiet, precise 1 second step advancement.
- Operates on one AA Battery, not included.
- Avoid minute hands longer than 3¼" to prolong battery life.
- Movement Size: 2³/₁₆" Square x 5/8" Thick.
- Can be enclosed in a case less than 3/4" thick.
- Center post diameter 5/16".

980.881 for Dials up to 1/8" thick \$7.95

980.882 for Dials up to 1/4" thick \$7.95

980.883 for Dials up to 5/8" \$7.95



980.881
980.882
980.883

Standard C Battery Movement

Ideal for your large clock projects where longer hands are used. Made in USA by the Japanese company Takane.

- Operates on one C alkaline battery, not included.
- Step second hand advancement.
- Snap in hanger.
- Features On-Off switch.
- Size: 3¹/₈"H x 2¹/₄"W x 1"D.
- Center post diameter 7/16".

980.812 for Dials up to 1/4" thick \$8.50

980.813 for Dials up to 3/4" thick \$8.50

980.812
980.813

High Torque Continuous Sweep Second Thinline Movement

Quiet continuous sweep feature in a mini movement. It provides 40% more torque than 980.882 and will drive larger hands.

- High torque - continuous second hand advancement.
- Operates on one AA Battery, not included.
- Size: 2³/₁₆" Square x 5/8" D.
- Center post diameter 5/16".

980.992 for Dials up to 1/4" thick \$14.75



980.992

CLOCK HANDS

Our clock hands fit all of our quartz movements.
 Hour and Minute are included with all movements.
 Second hands \$1.00 each purchased with movements.
 Available with black or brass finishes except where indicated.
 Illustrations reduced.

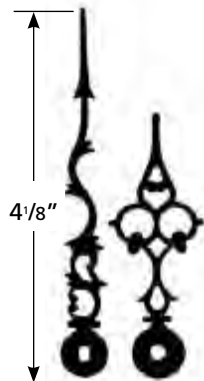

980.103.1 Black
 980.103.5 Brass

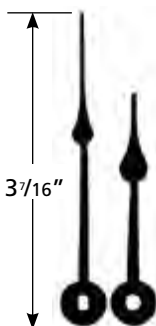

980.106.1 Black
 980.106.5 Brass

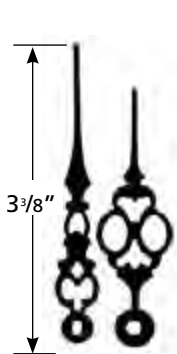

980.100.1 Black
 980.100.5 Brass

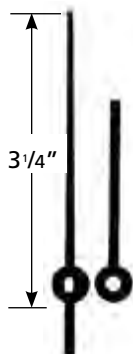

980.109.1 Black
 980.109.5 Brass

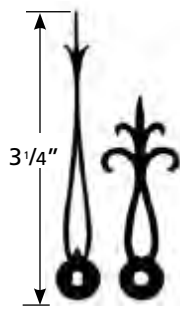

980.121.1 Black
 980.121.5 Brass

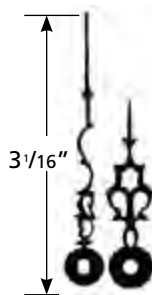

980.107.1 Black
 980.107.5 Brass

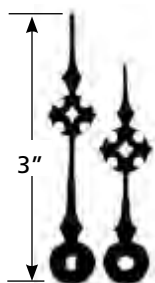

980.114.5 Brass

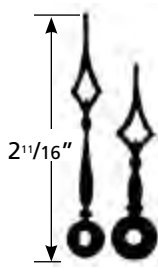

980.112.1 Black
 980.112.5 Brass

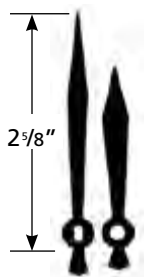

980.1020.1 Black
 980.1020.5 Brass

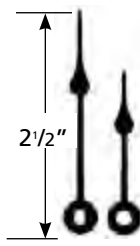

980.118.1 Black
 980.118.5 Brass

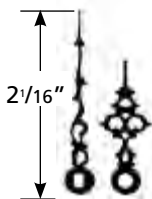

980.105.1 Black
 980.105.5 Brass

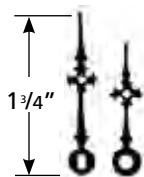

980.122.1 Black
 980.122.5 Brass

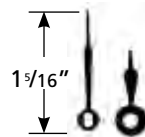

980.123.1 Black
 980.123.5 Brass

Large Hands

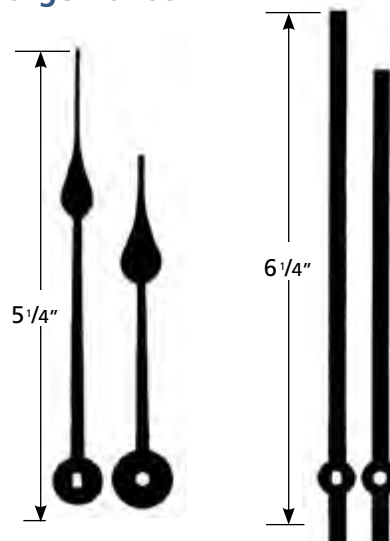

980.115.1 Black Only 980.120.1 Black Only

\$1.00 with movement purchase
 \$3.50 if purchased separately

Remember to specify hands
 when ordering movements.

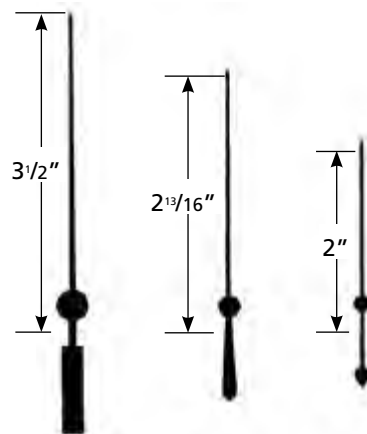

980.110 Brass 980.116 Brass 980.124 Brass
 980.111 Red 980.117 Red 980.125 Red
 980.126 Black

SWEEP SECOND HANDS \$1.50 each

Hour & Minute Hands

Hour & Minute Hands are included with
 movements. Additional Hands **\$1.50 pair**

Pocket Watch Keys

Individual keys for regulating clocks and winding watches. All have steel shanks and brass. In 13 sizes. India.

Number	Key Size	Hole M/M	Price	Number	Key Size	Hole M/M	Price
740.600	0	1.85	\$2.95	740.607	7	1.30	\$2.95
740.601	1	1.80	\$2.95	740.608	8	1.20	\$2.95
740.602	2	1.75	\$2.95	740.609	9	1.15	\$2.95
740.603	3	1.65	\$2.95	740.610	10	1.05	\$2.95
740.604	4	1.60	\$2.95	740.611	11	1.00	\$2.95
740.605	5	1.50	\$2.95	740.612	12	0.95	\$2.95
740.606	6	1.40	\$2.95				



740.600 -
740.612



740.502

Pocket Watch Key Assortment

Set of 14 sizes 00 to 12. Steel shanks with traditional brass.

740.502 **\$14.25**

5-in-1 Pocket Watch Keys

Even or Odd sizes.

740.500	2-4-6-8-10	\$7.75
740.501	3-5-7-9-11	\$7.75



740.500

740.501

Set of 2 Bench Keys for Clocks

Five prong brass clock keys cover sizes 2, 3, 4, 5, 6, 7, 8, 9, 10, and 11. Set of 2. Brass. Made in India.

240.623 **\$8.50**



240.623

Double End Key

American Gilbert 1-Day. 3.3 x 1.75mm

741.214 **\$4.25**



741.214



740.306 -
741.313

French Clock Keys

In eight mm sizes.

741.361	1-2.40	\$9.50
741.365	5-3.50	\$9.50
741.368	8-4.25	\$9.50



741.361 -
741.369



730.205

Single End Chime

In four mm sizes.

740.306	6-3.75	\$8.95
740.307	7-4.00	\$8.75
740.308	8-4.25	\$8.75
740.312	12-4.8	\$10.50
741.313	13-5.0	\$10.50

Alarm Clock Keys

Approximately 100 assorted nickeled keys for alarms.

730.205 **\$14.25/100**



560.305



Mini Tap Set

Screwplate with 14 taps for threading wire or re-threading stripped threads on screws. Sizes range from 0.7mm to 2.0mm.

560.305

\$29.75



241.581



240.580

Clock Hand/Gear Remover

Screw pressure pulls hands away from post. Also used for pulling small gears, etc. India.

240.580

\$13.75

Heavy Duty Hand and Gear Puller

For all types of clocks and instruments. Jaws adjust to fit over various sized hands and pusher is always centered. Screw pressure pulls hand or gear away from post or pinion. Does not touch dial. Jaws open 7/16", post is 1/16".

241.581

\$26.95



Horolovar Suspension Spring Units

Assembled with a Bestfit Temperature Compensating Suspension Spring and are guaranteed to have the correct specifications to fit.

781.203 3C Kundo Standard 55

\$43.50

781.206 65E Kundo Junior 56

\$43.50

781.208 6789 Schatz Standard 49

\$52.50

Individual Horolovar Suspension Springs

400-Day in packs of 3 springs.

781.123 .0023" / .058mm

\$9.50/3

781.132 .0032" / .081mm

\$9.50/3

781.135 .0035" / .089mm

\$9.50/3



Electric Clock Rotor

XC 44 x 94 Replaces: M3296 M3313 M3378 M3404 M3520 M3635

980.4494

\$11.95



Clock Hardware

10 black rubber and 10 brass washers for clock movements. (20 pieces total)

980.060

\$2.95



Brass Washers

100 assorted square and round brass washers for clock hands.

740.020

\$2.95



Taper Pins

200 assorted sizes.

641.10008 Steel \$31.95

641.10009 Brass \$31.95



Click Springs

25 assorted steel for alarm clocks.

641.10085*

\$69.95



Grandmother and Grandfather Suspension Springs

730.011 Grandmother \$20.95

730.012 Grandfather \$20.95



Clock Suspension Springs

Assortment of 2 each of 12 sizes. 24 pieces. Swiss.

740.990

\$104.95



Brass Wire

6" long in assorted gauges. 25 pieces.

430.500

\$13.75

Horn Anvil

For flattening and shaping. Polished round and flat horns, and hole in top for riveting. 4 1/2" across horns, 1 5/8" high. India.

121.305 **\$37.30**

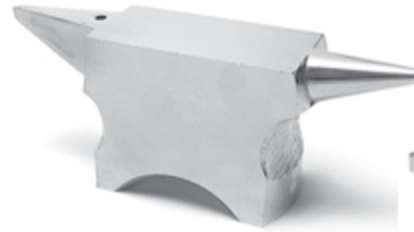

121.305

Horn Anvil

Case-hardened drop-forged steel. Essential to every jeweler. Heavy metal base has holes for mounting. Perfect for shaping precious metals. 3" high, 4 1/4". India.

120.301 **\$17.95**



120.301

Double-Horn Anvil

For precision work, miniature horn anvil is drop-forged steel which is then case hardened. 3 3/4" x 1 1/4". Swiss made.

120.300 **\$27.50**

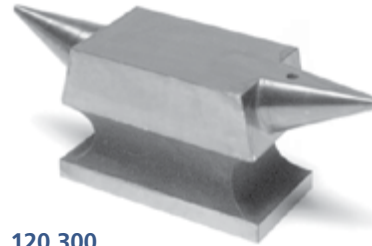

120.300

Steel Blocks

Support for flattening work and laying out designs. Block is case hardened, ground smooth, flat. 3/4" thick. India.

121.319 4" **\$27.85**

121.317 2 1/2" **\$18.65**

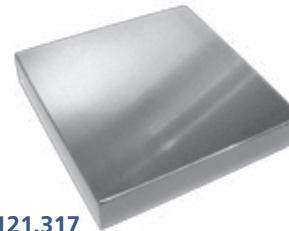

121.317
121.319

Hexagon Anvil

A base for staking, riveting and drilling small parts. Case hardened, ground flat and smooth. 16 holes from 3/64" to 1/4", and 5 milled slots. 1 5/8" across flats, 3/4" thick. India.

120.312 **\$11.50**

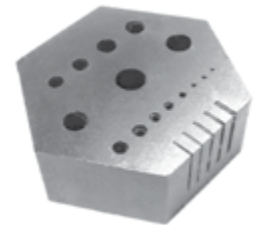

120.312

Slot Anvil

Base for staking, riveting and drilling small parts. V-slot is handy for removing pinions and similar items. Case hardened, ground flat and smooth. 9 graduated holes, one for stumps, and 5 milled slots. 1 3/4" x 1/4" x 1/2" thick.

120.315 **\$30.45**

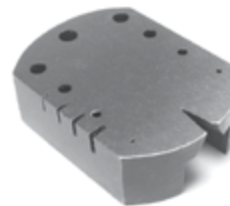

120.315

Bench Filing Block

Provides a 3 1/4" extension of the work bench. Consists of rubber block, iron frame and chilled steel anvil. Length 5", width 2 1/4".

131.200 **\$20.80**



131.200

Two Anvils in One

This anvil has a two-sided face; Hardened Steel and Nylon, both 2 3/8" diameter. Simply press the anvil out from the base and flip it over. Rubber, non-slip base provides secure positioning and absorbs light to heavy hammer action.

120.900 **\$23.95**



120.900

Bench Block

This hard steel base is seating in a cushioned rubberized block, preventing damage to fine work surfaces. Perfect for flattening wire, stamping, riveting, or distressing metal. Measures 3" x 3" x 1" high.

131.199 **\$14.95**

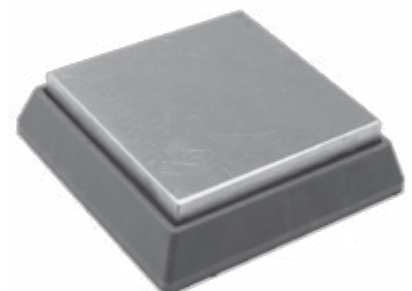

131.199



Top View



Bottom View

250.075

Metal Forming Block

Ideal for forming and shaping metal for ring shanks, name plates, etc. Eleven semi-circle and a V-shaped contours allow you many options. This two sided forming block is a must for any design or manufacturing shop.

250.075

\$85.60

Hardwood Dapping Block and Punches

For shaping lockets, cases, and removing dents. 2 1/4" cube with shallow depressions of different sizes on each face. Two punches.

251.135

\$9.95



251.135

European Beading Tools Set of 23

The world's hardest beading tools are superbly finished in the cone. 2.6 x 60mm diameter. Set of 23 includes handle and one each of size tip available (listed below).

530.160

\$31.50

Individual Tools

No.	Size	Price	No.	Size	Price	No.	Size	Price
531.161	0	\$1.85	531.169	8	\$1.90	531.177*	16	\$1.85
531.162	1	\$1.90	531.170	9	\$1.85	531.178	17	\$1.85
531.163	2	\$1.85	531.171	10	\$1.90	531.179	18	\$1.85
531.164	3	\$1.90	531.172	11	\$1.85	531.180	19	\$1.85
531.165	4	\$1.90	531.173	12	\$1.90	531.181	20	\$1.85
531.166	5	\$1.90	531.174	13	\$1.85	531.182	21	\$1.85
531.167	6	\$1.90	531.175	14	\$1.85	531.183	22	\$1.85
531.168	7	\$1.90	531.176	15	\$1.85			



530.160

Sets of Milgrain Tools

Cup-shaped cutters on wheels used to dress up a setting, ring mounting, or any piece of jewelry by forming a decorative bead or fine row of cuts along the edge. Sets contain six sizes plus chuck-holding handle. Sets in hardwood stand.

531.0210 Sizes 2, 4, 6, 8, 10, 12

\$99.50

531.100 Sizes 1-6

\$89.95

Replacement handles available.

Individual Tools

\$14.25 each

No.	Size	No.	Size	No.	Size	No.	Size
531.101	1	531.104	4	531.107	7	531.110	10
531.102	2	531.105	5	531.108	8	531.111*	11
531.103	3	531.106	6	531.109*	9	531.112	12



531.0210
531.100

12 Hole Beading Block

For reshaping ends of beading tool punches. Hardened steel, perfectly formed and highly polished. 12 holes, 1-12. France.

531.013

\$39.95



530.011



531.013

Beading Plate

For reshaping ends of beading tool punches. Specially hardened steel blocks, perfectly formed and highly polished. Swiss made.

530.011

\$58.25

Wood Handle with Chucks

Rounded handle with chucks that open from 0 to .128". Holds a variety of tools. Ideal for beading and milgrain tools. 3" long.

371.764 Handle with 2 Chucks **\$11.95**

371.767 Handle with 1 Chuck **\$10.50**

Swivel Tool Handle

Ball-shaped wood swivel handle fits palm of hand, making it useful for setting, reaming, tapping, etc. Comes with 2 chucks for holding burs and taps. Chucks open from 0 to .089". Overall 4".

371.769* **\$26.85**

Handle with Chuck

End of wood handle is bored and reinforced. Can be threaded onto tapered spindles so that small wheels, burs, etc. can be used on larger polishing motors. Chuck opens from .085" to .128" so that 3/32" and 1/8" mandrels will fit. 3 1/2" long.

371.760 Handle with Chuck **\$8.75**

371.761 Chuck only **\$4.05**

Automatic Center/Riveting Punch

Slim design for better visibility. Pushing down on body releases striking mechanism. Can be adjusted for light or heavy strokes.

471.860 **\$23.25**

Auto Center Punch

Spring-loaded 5" punch automatically strikes a sharp blow when pressed down firmly. Hardened, ground steel center point is well-tempered for long life. Convenient size for jewelry applications.

470.910 **\$8.35**

Automatic Center Punch

Can be adjusted for either light or heavy strokes. Pushing down on body releases striking mechanism. The punch is pointed.

471.850 **\$67.95**

Center Punch for Drill Starting

Used to make small dent as starting point for drill. Punch is tapped with small hammer. Made of steel with knurled handle for firm gripping surface. Slim design, can also be used as a scribe.

471.900 **\$2.75**

Set of 20 Pin Punches

Two each of 10 different size hardened steel punches. Flat tips range from .020" to .050" in diameter and are easily ground to make other sizes. Punches are 1 5/8" long, with a 3/32" shank. Used to drive out pins, broken screws, riveting, etc. Brass holder 3 1/4" long prevents damage from hammer.

471.890 **\$72.50**

Hole Punch Plier for Metal

Punch copper or silver as thick as 18 gauge. Ergonomic handles and tempered replaceable pin (one extra included). The 5 1/4" long plier is made of thick carbon steel.

460.107 Plier with 1.25mm Pin Diameter **\$14.25**

460.117 Plier with 1.80mm Pin Diameter **\$14.25**

371.764
371.765



371.769*



371.760



471.860



470.910



471.850

471.900



471.890



460.107
460.117

GRAVER HANDLES & HOLDERS



371.856

371.857 - 371.860

371.865 - 371.868

371.870

371.872

371.874

371.877



361.800*



531.070
531.0501*



360.110

371.850*
371.851*



260.419



260.500

Graver Handles

No.	Style	Diam x Lgth	No.	Style	Diam x Lgth
371.856	Gourd	1 ⁵ / ₁₆ x2 ¹ / ₂ "	371.868	Mushroom	1 ¹ / ₄ x2 ¹ / ₄ "
371.857	Half Head	1 ³ / ₈ x2"	371.870	Oval	1 ⁵ / ₁₆ x1"
371.859	Half Head	1 ³ / ₈ x1 ³ / ₄ "	371.872	Pear	1 ⁵ / ₈ x1 ⁷ / ₈
371.860	Half Head	1 ¹ / ₄ x2 ¹ / ₄ "	371.874	Round	1 ³ / ₈ x1 ⁵ / ₈
371.865	Mushroom	1 ¹ / ₄ x2"	371.877	Vase	1 ³ / ₈ x3"
371.867	Mushroom	1 ¹ / ₄ x1 ³ / ₄ "			

Graver Handles

\$2.10 each

Turning Gravers with Handles

Set of ten different shapes fitted with wood handles. For turning or pivoting items on small lathes. Made of tool steel with finished ground points.

361.800*

\$125.95

Faceted Gem Setting Gravers

For setting diamonds and other stones. Both sets consist of six gravers, six wood handles and a step-by-step model plate.

● Set No. 531.070 has gravers: onglette #0 and #1, flat #38 and #40 and round #50 and #52.

● Set No. 531.0501 has gravers: onglette #2, flat #38, knife #2, oval #65, square #6 and taper square #3.

531.070

\$85.50

531.0501*

\$82.95

Graver Blank

Grind your own graver with this carbide blank. Measures 3" long x 1/16" square.

360.110

\$23.50

E.F.B. Graver Handles

Graver slips into groove of hardwood handle and is held securely by metal sleeve. Especially for E.F.B. style gravers.

371.850* For Double End Gravers

\$8.95

371.851* For Single End Gravers

\$11.55

Universal Work Holder leaves your hands free

Versatile holder allows hands-free use while engraving, doing repairs, etc. The eight movable pins allow for secure grip on large and small pieces. Sturdy weighted base and easy adjustment knobs make this a handy workbench aid.

260.419

\$27.95

Peg Clamp

Firmly holds small odd shaped objects for engraving, filing, drilling, polishing and stone setting. 2" jaws open or close on twin guides by thumb screw. Four pegs can be positioned in any of the holes. Wood handle detaches for vise mounting. 5⁵/₈". India.

260.500 Peg Clamp with 4 Pegs

\$20.20

261.501 Set of 4 Pegs

\$4.25

Grobet High Speed Yellow Tang Gravers

Used by engravers, stone setters, die sinkers, jewelers, and watchmakers for all types of metals, wood, bone, ivory, onyx.



ROUND EDGE - \$12.95 each

Item #	361.319	361.320	361.322	361.323
Graver #	50	51	52	53 54
Thickness mm	0.2	0.4	0.6	0.8 1.0



KNIFE - \$12.95 each

Item #	361.340	361.341	361.342	361.343
Graver #	0	1	2	4
Thickness mm	1.8	2.0	2.2	2.6



ONGLETTE - \$8.95 each

Item #	361.259	361.261	361.263	361.265	361.267	361.269	361.270	360.271	361.272	361.273	361.274	361.275	361.276
Graver #	5/0	4/0	3/0	2/0	0	1	2	3	4	5	6	7	8
Thickness mm	1.16	1.24	1.35	1.45	1.58	1.78	1.94	2.16	2.54	2.74	2.94	3.14	3.36

Grobet Pre-Shaped Gravers



ONGLETTE - \$12.95 to \$18.65 each

Item #	361.327	361.328	361.329	361.330	361.331	361.332	361.333	361.334	361.335	361.336	361.337	361.338
Graver #	5/0	4/0	3/0	2/0	0	1	2	3	4	5	6	7
Thickness mm	1.16	1.24	1.35	1.45	1.58	1.78	1.94	2.16	2.54	2.74	2.94	3.14
Price	\$12.95	\$12.95	\$12.95	\$14.55	\$12.95	\$12.95	\$12.95	\$12.95	\$12.95	\$18.65	\$14.55	\$14.55



FLAT EDGE - \$14.75 each

Item #	361.308	361.309	361.310	361.311	361.312	361.313	361.314	361.315	361.316	361.317	361.318
Graver #	36	37	38	39	40	41	42	43	44	45	47
Thickness mm	0.2	0.4	0.6	0.8	1.0	1.2	1.4	1.6	1.8	2.0	2.4



FLAT - \$14.75 each

Item #	361.277	361.278	361.279	361.27901	361.281	361.281	361.282	361.283	361.284	361.285
Graver #	36	37	38	39	40	41	42	44	45	47
Thickness mm	0.2	0.4	0.6	0.8	1.0	1.2	1.4	1.8	2.0	2.4



ROUND - \$14.75 each

Item #	361.289	361.290	361.29101	361.292	361.293	361.294
Graver #	50	51	52	53	54	55 57
Thickness mm	0.2	0.4	0.6	0.8	1.0	1.2 1.6



KNIFE - \$14.75 each

Item #	361.300	361.301	361.302	361.303	361.304	361.305
Graver #	0	1	2	3	4	5
Thickness mm	1.8	2.0	2.2	2.4	2.6	2.8

Hermes Inside Ring Engraving Machine

Engraves the inside of rings. Automatically centers ring in clamping jigs. Engraving and spacing is synchronized and easy. The diamond insert produces a hand engraved effect. Comes with extended gothic and tilted block copy dial. Letters measure approximately 6.5mm. Ship. Weight 15lbs.

261.390*	Hermes Inside Ring Engraver	\$2295.00
261.391	Connecting Script Dial	\$479.00
261.802/7	Replacement Diamond Stylus	\$16.50

Special Order

The ultimate in manual inside ring engravers, the Hermes makes engraving inside rings easy. Simple to operate. Professional results can be achieved by even the inexperienced jeweler.



261.390*



260.377

PEPETOOLS® Deluxe Horizontal Engraving Machine

- Adjustable combination type slide accommodates both large 2¾" and small 1¼" font blanks. Includes single line block type.
- Height adjustment up to 4½". 15 different pantograph ratios from 2½:1 to 6:1.
- Easy type insertion of letters in middle of mounting channel - no need to slide in from ends.
- Vise rotates a full 360° with stops at every 45° increment.
- "Quick-Slide" vise holds plates up to 4" circular or rectangular.
- Set of 4 brass pins to hold items being engraved.
- Diamond stylus.
- Measures: 11"H x 14"W x 14½"D.
- Made in Europe. Complete set of instructions included.

260.377 **\$659.00**

Engrave bracelets, watches, charms, lighters, pens, anything that is flat or semi-curved.

Vigor Engraving Machine Replacement Diamond Tip

The Vigor Engraver is no longer available, but you can still get a replacement diamond tip to keep your engraver going!

261.385 **\$49.95**

Practice Material for Engraving

261.540	Copper Rings	\$2.25 ea
361.01556	Brass Sheets 27/8" x 9/16"	\$34.95/pk of 12



261.540

361.01556

Engraving supplies - see page 267.

Hermes Engraving Machines

Super Engravograph Floor Model

The Super Engravograph is a sturdy floor model engraver designed to accommodate odd-shaped, cylindrical and flat objects such as bowls, cups, trays, trophy plaques. Control panels clamped in a versatile work-holding vise. Will engrave items up to 14³/₄" high by any length, odd shaped objects up to 8" thick and cylindrical objects up to 6". Jewelry and nameplate holding jig included. Copy holding slide, slide converter and type must be ordered separately.

- 25 engraving ratios from 2:1 to 7:1.
- Maximum vise opening 18".
- 3" x 12" maximum work range at 2:1 ratio
- 6" x 16" graduated table for multi type holding slides.
- Auto-indexing system.
- Comes with 4 cones to engrave items up to 6" in diameter.
- Includes machine stand.
- Approximate dimensions: 30" x 22" x 25".
- Shipping weight 100 lbs.

261.373* Engravograph with diamond assembly	\$6895.00
261.374* Motor & rotating spindle attachment	\$1275.00

Accessories:

261.378* Slide converter 26" long	\$234.95
261.379* Double grooved copy slide 26" long	\$469.00
261.380 Replacement jewelry and nameplate jig	\$99.95
261.381* Watch and lighter jig	\$103.95
261.382 Signet ring jig	\$179.95
261.383* Pen jig	\$159.50
261.384* Plaque jig for No. 261.373	\$219.00
261.385 1/8" diamond insert	\$49.95
261.386* 1/8" diamond insert for wide engraving	\$102.50
261.387* Insert for pen engraving	\$54.10
261.388* Insert for pen for wide engraving	\$54.10

Description of set contents may differ.

Deluxe Engravograph

This lightweight and compact engraving machine is designed for businesses with limited space. Its automatic centering capabilities make it simple to operate for any first-time engraver. Ideal for jewelry, nameplates, badges, machine parts, etc. Will engrave plates up to 5¹/₂" high or odd shaped objects up to 1³/₄" thick. Complete with a 360° rotating work vise with a maximum opening of 5³/₄" and a 26" double grooved copy slide holder. Specifications:

- 25 engraving ratios from 2:1 to 7:1.
- Pivoting pantograph arm.
- Approximate dimensions 16" x 22" x 15".
- Shipping weight 25 lbs.

261.370* Engravograph with diamond assembly	\$3925.00
261.371* Motor and rotating spindle attachment	\$1549.25

BEADSMITH® Cordless Micro Engraver

Battery powered, diamond tip, easy to use tool is ideal for engraving metal, glass, wood, ceramics and more!

- Comfortable contoured grip allows for greater control.
- Includes 2 sizes round diamond-tip bits and an allen wrench.
- Retail packaging.
- Battery operated (2-AAA, not included).

360.120	\$16.75
360.120.T Replacement Bits, Set of 2	\$2.65



261.373* Machine pictured with motor and rotating spindle

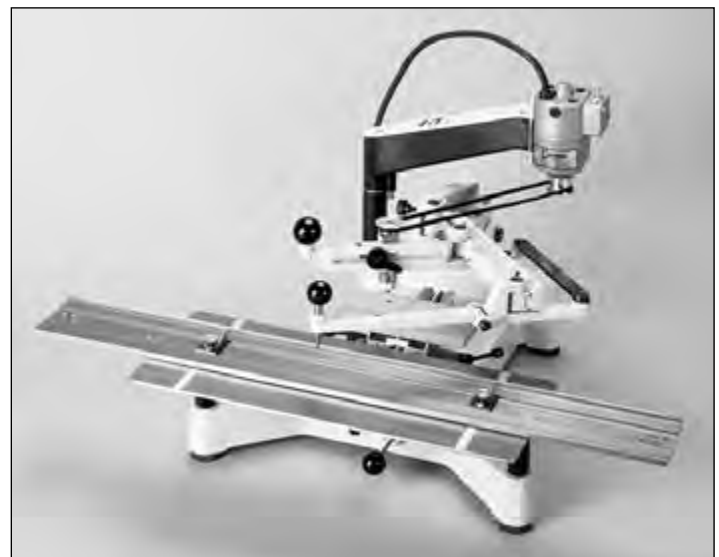

261.370* Machine pictured with motor and rotating spindle



360.120

360.120T



Crocker Pattern Graver Sharpener

Graver can be set to any angle by setting index. Holds graver edge in position while honing on oilstone (not supplied).

361.880

\$74.95

Bergeon 2462 Graver Sharpener

Special feature of this sharpener is the elongated shield that holds the graver in an immovable position during the sharpening action. Gravers can be sharpened at any angle. Screw on top locks graver and also serves as finger rest.

640.2462

\$128.50

Graver Sharpener

Graver is placed in either of two angled openings and rolled over flat oilstone to sharpen. Measures 2 1/8" x 1 3/8".

361.884

\$10.45

Precious Metal Hand Stamps

Made of hand-cut steel to stamp impressions on metal surfaces. Sizes noted indicate the height of the impression.



Bent Stamps

	Size #1	Size #2	Size #3	Price
Mark	1/24"/1.1mm	1/32"/0.8mm	1/45"/0.5mm	
10K	550.251	550.252	550.253	\$18.50
14K	550.261	550.262	550.263	\$18.50
18K	550.271	550.272	550.273	\$18.50
STER	550.301	550.302	550.303	\$24.95
PLAT	-----	550.322	550.323	\$23.75

Straight Stamps

	Size #1	Size #2	Size #3	Price
Mark	1/24"/1.1mm	1/32"/0.8mm	1/45"/0.5mm	
10K	550.282	-----	-----	\$18.50
14K	550.291	550.292	550.293	\$23.95
STER	550.311	550.312	550.313	\$24.95

Ring Stamping Device

Holds stamps with approximately 5/16" square bodies. Eliminates the need to hold ring and stamp in one hand. Simply position ring over the mar-proof nylon anvil and tap stamp with mallet. Also ideal for flat stamping. Sleeve can be reversed or the stamp body can be filed to fit 5/16" square. Order hand stamps separately.

551.200

\$41.75

Stainless Jewelry Marking Pliers

Can be used on curved or flat surfaces to stamp inside rings as small as size 4. Easy to use, requires no set-up and no hammering. Little pressure is needed to stamp precious metals including white gold. Durable stainless steel with adjustable screw to lock stamp in place. 5 1/2" long. Punches not included, see below.

461.02405

\$73.45

Punches for No. 461.02405

551.02401/1*	10K	\$30.45	551.02401/7*	STER	\$42.05
551.02401/2*	14K	\$30.45	461.02401/4*	Nylon Anvil	\$3.75
551.02401/3*	18K	\$30.45			

Steel Burnishers

Oval-shaped tool steel for smoothing of bezels around stones and other parts of soft metals. Polished blades in wood handles.

Curved	Blade	Price	Straight	Blade	Price
180.050	1½"	\$9.95	181.060	1½"	\$14.95
181.052	2"	\$16.30	181.062	2"	\$16.20
181.053*	2½"	\$17.40	181.063*	2½"	\$16.30
181.054*	3"	\$18.20	181.064*	3"	\$25.55

Economy Burnishers

Oval shaped steel blade with fine point mounted in wood handle. For smoothing and polishing bezels.

180.048	Curved	\$2.90
180.049	Straight	\$2.90

Slim Steel Burnishers

Perfect for smaller jobs. Highly polished steel assures the user a smooth finish every time. Hardwood handles. 6¼" long.

180.045	Slim Bent	\$5.25
180.047	Slim Straight	\$5.25

Slim Blade Burnishers

Especially useful for jewel settings. Blade 1¾" long.

181.058	Curved Blade	\$21.40
181.059*	Straight Blade	\$17.15

Stainless Burnisher

Stainless steel with comfortable PVC grip. Especially handy for small jobs, precious metal, clay work and a variety of other tasks. Highly polished tips. 6¼" long.

180.061*	3.5mm diameter	\$5.50
180.039	2.0mm diameter	\$5.50

Pocket Scriber with Carbide Tip

End is reversible so that point is protected while carrying.

521.950	Waller Scriber	\$9.95
521.951	Replacement tip	\$8.40

Diamond Tipped Scriber

Can be used on hardest jewels, metals, etc. Hexagonal aluminum handle prevents rolling on bench. Length 5¼".

521.954	\$22.15
----------------	----------------

Carbide Tipped Scriber

Can be used on hardest metals, glass, jewels, etc. Slim-line design and comfortable to use. Hexagonal aluminum handle prevents rolling. Length 5¼".

521.952	\$7.95
----------------	---------------

Pocket Scriber with Knurled Chuck

For marking and scribing steel, copper, brass and aluminum. Replaceable hardened tool steel point. Point reverses into body for safety. Nickel plated body. Hexagon head prevents rolling. 521.958 is an economy version of 521.959.

No.	Handle Diameter	Blade Length	Price
521.958	1/4"	23/8"	\$9.00
521.959	1/4"	23/8"	\$21.80
521.960*	3/8"	27/8"	\$23.50
521.961	Point for 521.958 & 521.959		\$2.10
521.962	Point for 521.960		\$2.00



Carbide Scribe with Magnet

Knurled aluminum holder 5/16" diameter and 5¼" long with 1/8" tungsten carbide tip firmly pressed into one end and a magnet on the other. Handy pocket clip and a point protector for safety.

520.953	\$9.50
----------------	---------------

151.301 - 151.380

151.500
151.501

151.505
151.506

151.520 - 151.526

641.30543*

150.510

150.540

Cutting Broaches, Bergeon Assortment #4251

12 broaches .33mm to .69mm at 10mm of large end, #70-80.

640.4251 \$33.50

640.4251

More broaches on page 98.



English Pattern Five-Sided Cutting Broaches

Cutting, cleaning and finishing broaches made of high quality steel and uniformly tempered for long life. The lengths vary from approximately 1³/₄" to over 7", with diameters gauged slightly below largest portion of the cutting edges.

No.	Stubs	Width	Price	No.	Stubs	Width	Price
151.301*	1	.227"	\$14.20	151.352*	52	.063"	\$4.85
151.305*	5	.204"	\$12.35	151.354*	54	.055"	\$3.20
151.310*	10	.194"	\$10.95	151.355*	55	.050"	\$3.00
151.315*	15	.180"	\$11.05	151.358*	58	.042"	\$3.00
151.320*	20	.161"	\$8.50	151.360*	60	.039"	\$2.75
151.325*	25	.148"	\$7.95	151.362*	62	.038"	\$3.00
151.330	30	.127"	\$6.50	151.365*	65	.033"	\$3.00
151.335	35	.108"	\$4.85	151.368*	68	.031"	\$3.00
151.340*	40	.097"	\$4.00	151.370*	70	.027"	\$2.75
151.345*	45	.081"	\$4.00	151.372	72	.024"	\$2.45
151.348*	48	.075"	\$4.00	151.375	75	.020"	\$3.00
151.350*	50	.069"	\$3.25	151.380*	80	.013"	\$2.75
151.351*	51	.067"	\$3.50				

Cutting Broach Sets

Each set contains 12 of the most used sizes for general cutting purpose work. In tubes.

151.500	Stubs 15-70	\$44.75
151.501	Stubs 30-70	\$47.00

Round Broach Sets

Each contains 12 of the most used sizes for general purpose work. Packed in tubes. No.151.0506 has a broach holder.

151.513	Stubs 15-70	\$47.00
151.514	Stubs 30-70	\$47.00
151.0506*	Stubs 55-80	\$50.45

Cutting Broach Sets with Holder

Each contains 12 of the most used cutting sizes. Packed in tubes with broach holder.

151.505	Stubs 15-70	\$55.70
151.506	Stubs 30-70	\$47.00

Mascot Pivot Broaches

Superior quality, perfectly tapered and true to size for precision work. All have round handles and are 1³/₄" long. 1 dz. per pack.

Diameters	No.	Style	Per Dz	No.	Style	Per Dz
.003"- .013"	151.520	Cutting	\$28.95	151.525	Round	\$28.95
.005"- .015"	151.521	Cutting	\$28.95	151.526	Round	\$28.95
.008"- .018"	151.522	Cutting	\$28.95			

Knurled Handle Broach Sets

Finest alloy steel, highly ground and polished. Sets contain seven of the most frequently used sizes from Stubs 28 to 70.

641.30543*	Smoothing	\$68.50
641.30544T*	Cutting	\$53.50

Assortment of Six Broaches

Assortment of six popular sizes with plastic handles contains No. 46 through 72 (according to English Stubs gauge). Five-sided with a regular taper and perfect finish. Germany.

150.510 \$12.75

Extra Fine Broach Set with Pin Vise

12 extra-fine broaches .05mm to .55mm. Includes pin vise.

150.540 \$20.25

Busch® Jewelers' Burs

Jeweler's burs are made of tungsten vanadium steel. 3/32" diameter shanks, are approximately 1 3/4" long and are used with flex shaft machines or micromotors. Made in Germany with a reputation for quality.

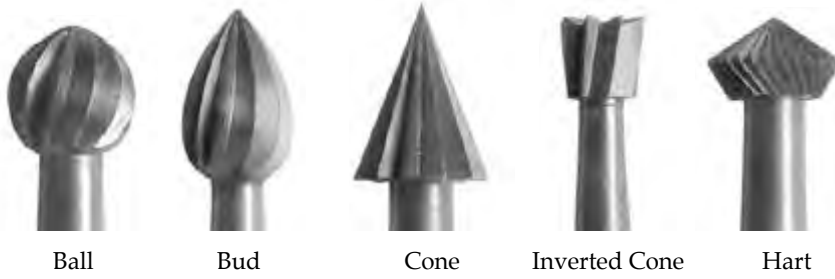

Ball Bud Cone Inverted Cone Hart



Multiple Shape Bur Assortments Small Size

Set of various shaped burs in wood box. Contains 12 burs: three each of ball, bud, cone and inverted cone, in sizes 1, 5 & 8.

181.157 \$22.75

181.157
181.158

Large Size

Set of various shapes in wood stand. Contains 12 burs: three each of ball, bud, cone and hart in sizes 6, 10 and 14.

181.158 \$34.30



180.170 180.799



180.799



181.150 Ball 181.151 Bud 180.153 Cup 181.154 Hart

Busch Concave & Knife Edge Steel Cutters

The Clean Cut Cup Bur slits and the cross-recessed head discharge gold chips preventing clogged burs.

The Knife Edge Burs feature a 55° angle and are ideally suited for working within thin prongs of your finest stone settings.

Available individually: Concave Cutters sizes 010 - 023. Knife Edge Cutters sizes 010 - 035.

180.170 Concave, 10-piece Assortment	\$33.50
180.799 Knife Edge, 24-piece Assortment	\$61.50
180.799.010 thru 180.799.023 Knife Edge, Individual	\$2.75 ea
180.799.024 thru 180.799.029 Knife Edge, Individual	\$3.95 ea
180.799.030 thru 180.799.035 Knife Edge, Individual	\$4.95 ea

Single Shape Bur Assortments

Single shape burs in assorted sizes.

181.150 Ball - 12 Burs	\$17.95
181.151 Bud - 15 Burs	\$37.75

BUSCH Cup Bur Set

Tungsten vanadium steel. 3/32" shanks and are approximately 1 3/4" long. Assortment contains 12 pieces. Refills available.

180.153 \$36.00

BUSCH Hart Bur Set

Tungsten vanadium steel. 3/32" shanks and are approximately 1 3/4" long. Assortment contains 12 pieces. Refills available.

181.154 \$53.85



Busch 45° Hart Bur Assortments

Tungsten vanadium steel burs in twelve and six piece sets.

180.155 12 Sizes 010-031	\$39.95
180.156 6 Sizes 033-045	\$31.00



Busch

Krause Cross Cut Burs

Busch specially shaped, long flame crosscut burs ideal for removing investment residue and finishing in hard to reach areas. Vanadium steel, 3/32" shank.

Busch #256	ISO Size	Head Diam.	Price
180.571	010	.0393"	\$2.95
180.572	012	.0472"	\$2.95



Busch

Busch Wax Burs and Stone Cutters

Busch #260A	ISO Size	Head Diam.	Price
180.576	018	.0709"	\$4.50
180.578	023	.0906"	\$4.50
180.582	031	.1220"	\$6.95
180.590	050	.1968"	\$6.95



Busch

Wheel Cutters with Knife Edge

Busch #161KE	ISO Size	Head Diameter	Price
180.646	060	.2362"	\$13.95
180.647	070	.2756"	\$14.95
180.648	080	.3149"	\$15.50
180.650	120	.4724"	\$27.25
180.654	140	.5512"	\$29.50



Busch

Wheel Burs with Saw Edge

Busch Brand #231S	ISO Size	Head Diameter	Price
180.676	023	.0906"	\$2.75
180.675	050	.1968"	\$4.95
180.680	100	.3937"	\$12.95



Busch Fast Cutting Cup Burs

Fast cut cup burs from Busch® feature a blade design that allows for faster cutting, assuring longer life for the bur and higher production for the jeweler. Germany.

Number	ISO	M/M	Number	ISO	M/M
180.413	010	1.00	180.417	016	1.60
180.414	012	1.20	180.418	018	1.80
180.415	014	1.40	180.419	021	2.10
180.416	015	1.50	180.420	023	2.30
180.413 thru 180.420			\$2.65 ea		



Busch STARLIGHT Polisher

Made of the very finest carbide, this polisher lends a unique brilliant finish on platinum and gold. Busch No.552 023, 2.3mm diameter, 4.0mm length with 3/32" shank. Optimum results are achieved with speeds between 25,000 to 35,000 RPM. Polishing applications: highlights on curved ring shanks, on elevated edges, for partial highlights on larger objects, for brilliant polish effects at recessed or difficult accessible points.

180.033	\$36.75
----------------	----------------

Economy Diamond Points

Economical and functional. A good value for the novice or hobbyist. Use on ceramic, glass or stones. Set contains 20 most popular shapes and sizes on 3/32" shanks of 1 3/4" length. 120 grits diamond. In plastic storage box. China.

110.144 **\$10.95**



110.144

Diamond Points - sharper than carbide

Set of 12. Diamond particles are electro-plated onto stainless steel for unequalled quality - stays sharp longer than carbon. Each has a 3/32" shaft and is 1 3/4" long - the same as standard burs. Excellent for stone carving, cleaning work, glass, ceramics and metals. Always use water or a diamond lubricant when using diamond instruments of any kind.

110.145 **\$54.95**



110.145



**Tungsten
Vanadium**



Diameters				Ball Busch #1	Price	Wheel Busch #2	Price	Cone Busch #5	Price	Cone Sq. Cross Cut Busch #23	Price	Setting Busch #413	Price
Size	ISO	MM	Inches										
9/0	0025	0.25	0.0094	180.172	\$2.50	—	—	—	—	—	—	—	—
8/0	003	0.30	0.0118	180.173	\$2.50	—	—	—	—	—	—	—	—
7/0	0035	0.35	0.0138	180.174	\$2.50	—	—	—	—	—	—	—	—
6/0	004	0.40	0.0157	180.175	\$1.75	—	—	—	—	—	—	—	—
5/0	005	0.50	0.0197	180.176	\$1.10	—	—	—	—	—	—	—	—
4/0	006	0.60	0.0236	180.177	\$1.10	180.211	\$1.10	—	—	—	—	—	—
3/0	007	0.70	0.0276	180.178	\$1.10	180.213	\$1.10	—	—	180.338	\$1.40	—	—
2/0	008	0.80	0.0315	180.179	\$1.10	180.215	\$1.10	—	—	180.339	\$1.40	—	—
0	009	0.90	0.0354	180.180	\$1.10	180.217	\$1.10	180.290	\$1.10	180.340	\$1.40	—	—
1/2	0095	0.95	0.0382	180.181	\$1.10	—	—	—	—	—	—	—	—
1	010	1.00	0.0393	180.182	\$1.10	180.219	\$1.10	180.291	\$1.10	180.341	\$1.40	180.001	\$2.70
1-1/2	011	1.10	0.0441	180.183	\$1.10	—	—	—	—	—	—	180.002	\$2.70
2	012	1.20	0.0472	180.184	\$1.10	180.221	\$1.10	180.292	\$1.10	180.342	\$1.40	—	—
2-1/2	013	1.30	0.0500	180.185	\$1.10	—	—	—	—	—	—	—	—
3	014	1.40	0.0551	180.186	\$1.10	180.223	\$1.10	—	—	180.343	\$1.40	—	—
3-1/2	0145	1.45	0.0559	180.187	\$1.10	—	—	—	—	—	—	—	—
4	015	1.50	0.0591	180.188	\$1.10	—	—	—	—	—	—	180.004	\$2.70
4-1/2	0155	1.55	0.0622	180.189	\$1.10	—	—	—	—	—	—	—	—
5	016	1.60	0.0630	180.190	\$1.10	180.225	\$1.10	180.295	\$1.10	180.346	\$1.40	—	—
5-1/2	017	1.70	0.0689	180.191	\$1.10	—	—	—	—	—	—	180.005	\$2.70
6	018	1.80	0.0709	180.192	\$1.10	180.226	\$1.10	180.296	\$1.10	180.348	\$1.40	—	—
6-1/2	019	1.95	0.0776	180.193	\$1.10	—	—	—	—	—	—	—	—
6-3/4	020	2.00	0.0787	180.171	\$1.00	—	—	—	—	—	—	180.006	\$2.70
7	021	2.10	0.0827	180.194	\$1.10	180.227	\$1.10	180.297	\$1.10	180.350	\$1.40	—	—
7-1/2	022	2.20	0.0866	181.195	\$1.00	—	—	—	—	—	—	180.007	\$2.70
8	023	2.30	0.0906	180.196	\$1.10	180.228	\$1.10	180.298	\$1.10	—	—	—	—
8-1/2	024	2.40	0.0953	180.197	\$2.95	—	—	—	—	—	—	—	—
9	025	2.50	0.0984	180.198	\$2.95	180.229	\$2.15	180.299	\$3.75	180.354	\$3.20	180.009	\$4.55
9-1/2	026	2.60	0.1031	180.199	\$2.15	—	—	—	—	—	—	—	—
10	027	2.70	0.1063	180.200	\$2.95	180.230	\$2.15	180.300	\$3.75	180.356*	\$3.25	180.010	\$4.55
10-1/2	028	2.80	0.1102	—	—	—	—	—	—	—	—	—	—
11	029	2.90	0.1141	180.201	\$2.95	180.231	\$2.15	180.301	\$3.60	180.357*	\$3.25	—	—
11-1/2	030	3.00	0.1181	—	—	—	—	—	—	—	—	—	—
12	031	3.10	0.1220	180.202	\$2.95	180.232	\$4.15	180.302	\$4.95	180.358*	\$3.60	—	—
12-1/2	032	3.20	—	—	—	—	—	—	—	—	—	180.011	\$5.95
13	033	3.30	0.1299	180.203	\$2.95	—	—	180.303	\$3.55	—	—	—	—
14	035	3.50	0.1378	180.204	\$2.95	180.233	\$4.15	180.304	\$4.95	—	—	180.014	\$5.70
15	037	3.70	0.1457	180.205	\$4.75	—	—	180.305	\$3.75	—	—	180.015	\$5.95
16	040	4.00	0.1575	180.206	\$4.75	180.234	\$4.15	180.306	\$6.00	—	—	180.016	\$7.90
17	042	4.20	0.1654	180.207	\$4.75	—	—	180.307	\$4.50	—	—	180.017	\$7.90
18	045	4.50	0.1772	181.208	\$4.15	180.235	\$4.15	180.308	\$6.00	—	—	180.018	\$7.50
19	047	4.70	0.1850	181.209	\$4.15	—	—	180.309	\$4.50	—	—	180.019	\$7.90
20	050	5.00	0.1968	180.210	\$4.75	180.236	\$4.50	180.310	\$6.00	—	—	180.020	\$7.90
22	055	5.50	0.2162	180.212	\$6.65	—	—	180.311	\$5.75	—	—	180.022	\$7.90
24	060	6.00	0.2358	180.214	\$6.65	—	—	180.312	\$5.75	—	—	180.024	\$7.90
26	065	6.50	0.2554	180.216	\$6.65	—	—	180.313	\$5.75	—	—	—	—
28	070	7.00	0.2751	180.218	\$6.65	—	—	—	—	—	—	180.028	\$7.90
30	075	7.50	0.2948	180.220	\$8.25	—	—	180.315	\$7.25	—	—	—	—
32	080	8.00	0.3144	180.222	\$8.25	—	—	—	—	—	—	180.032	\$10.25
34	085	8.50	0.3341	180.224	\$8.25	180.317	\$7.25	—	—	—	—	—	—



Size	ISO	Inverted Cone Busch #3 Price	Flame Cross Cut Busch #27 Price	Cylinder Square Busch #15 Price	Hart Busch #156C Price	Round Finishing Busch #145 Price	Bearing Cutter Busch #446 Price	Twist Drill Busch #77 Price
5/0	005	—	—	—	—	—	—	280.584 \$2.75
4/0	006	180.537 \$1.10	—	—	—	—	—	280.585 \$2.75
3/0	007	180.538 \$1.10	—	180.468 \$1.50	—	—	—	280.586 \$2.75
2/0	008	180.539 \$1.10	180.565*\$1.40	180.469 \$1.50	—	180.550 \$1.75	—	280.587 \$2.75
0	009	180.540 \$1.10	180.566*\$1.40	180.470 \$1.50	180.500 \$2.60	180.551 \$1.75	—	280.588 \$2.75
1/2	0095	—	—	—	180.521 \$2.60	—	—	—
1	010	180.541 \$1.10	180.567*\$1.40	180.472 \$1.50	180.501 \$2.90	180.552 \$1.75	180.600 \$2.90	280.589 \$2.75
1-1/2	011	—	—	—	180.522 \$2.60	—	—	—
1-3/4	0115	—	—	—	—	—	—	—
2	012	180.542 \$1.10	180.568*\$1.40	180.474 \$1.50	180.502 \$2.60	180.553 \$1.75	180.601 \$2.90	280.590 \$2.75
2-1/4	0125	—	—	—	—	—	—	—
2-1/2	013	—	—	—	180.523 \$2.60	—	—	—
2-3/4	01375	—	—	—	—	—	—	—
3	014	180.543 \$1.10	180.569*\$1.40	180.476 \$1.50	180.503 \$2.60	180.554 \$1.75	180.602 \$2.75	280.591 \$2.75
3-1/2	0145	—	—	—	180.524 \$2.60	—	—	—
4	015	180.544 \$1.10	—	180.477*\$1.50	180.504 \$2.60	—	—	280.592 \$2.75
4-1/2	0155	—	—	—	—	—	—	—
5	016	180.545 \$1.10	—	180.480*\$2.30	180.505 \$2.60	180.555 \$1.75	180.603 \$2.90	280.593 \$2.75
5-1/4	0165	—	—	—	—	—	—	—
5-1/2	017	—	—	—	180.526 \$2.60	—	—	—
5-3/4	0175	—	—	—	—	—	—	—
6	018	180.546 \$1.10	—	180.482 \$2.40	180.506 \$2.60	180.556 \$1.75	180.604 \$2.75	280.594 \$2.75
6-1/2	019	—	—	—	180.527 \$2.60	—	—	—
6-3/4	020	—	—	—	180.533 \$2.60	—	—	—
7	021	180.547 \$1.10	—	180.484 \$2.40	180.507 \$2.60	180.557 \$1.75	180.605 \$2.75	280.595 \$2.75
7-1/2	022	—	—	—	180.528 \$2.60	—	—	—
8	023	180.548 \$1.10	—	180.486 \$1.60	180.508 \$2.60	180.558 \$1.75	180.606 \$2.90	280.596 \$2.75
8-1/2	024	—	—	—	180.529 \$3.50	—	—	—
9	025	180.549 \$2.15	—	—	180.509 \$3.50	—	180.607 \$3.50	—
9-1/2	026	—	—	—	180.530 \$3.50	—	—	—
10	027	—	—	180.490*\$2.90	180.510 \$3.50	180.559 \$7.00	180.608 \$6.15	—
10-1/2	028	—	—	—	180.531 \$3.50	—	—	—
11	029	—	—	—	180.511 \$3.50	—	180.609 \$6.15	—
11-1/2	030	—	—	—	—	—	—	—
12	031	—	—	180.492 \$4.95	180.512 \$4.95	180.560 \$7.85	—	—
13	033	180.53502 \$3.25	—	—	180.513 \$4.95	—	—	—
14	035	—	—	—	180.514 \$4.95	—	—	—
15	037	180.53504*\$3.60	—	—	180.515 \$4.95	—	—	—
16	040	180.53505*\$3.60	—	—	180.516 \$6.10	—	—	—
17	042	180.53506*\$3.60	—	—	180.517 \$6.10	—	—	—
18	045	180.53507*\$3.60	—	—	180.518 \$6.10	180.563 \$8.40	—	—
19	047	180.53508*\$3.60	—	—	181.519 \$6.60	—	—	—
20	050	180.53509*\$3.60	—	—	180.520 \$6.10	180.564 \$8.40	—	—



Diameters				Cone Square Plain		Bud		Short Bud		Cup		Fast Cut Cup		Square Cross Cut	
Size	ISO	MM	Inches	Busch #17	Price	Busch #6	Price	Busch #6A	Price	Busch #77B	Price	Busch #411C	Price	Busch #21	Price
5/0	005	0.50	0.0197	—	—	—	—	—	—	—	—	—	—	—	—
4/0	006	0.60	0.0236	—	—	180.237	\$1.15	—	—	—	—	—	—	180.427	\$1.60
3/0	007	0.70	0.0276	180.368	\$1.50	180.238	\$1.15	—	—	—	—	—	—	180.428	\$1.60
2/0	008	0.80	0.0315	180.369	\$1.50	180.239	\$1.15	—	—	—	—	—	—	180.429	\$1.60
0	009	0.90	0.0354	180.370	\$1.50	180.240	\$1.15	180.272	\$1.05	180.400	\$2.65	—	—	180.430	\$1.60
1/2	0095	0.95	0.0382	—	—	—	—	—	—	—	—	—	—	—	—
1	010	1.00	0.0393	180.371	\$1.50	180.241	\$1.15	180.273	\$1.05	180.401	\$2.65	180.413	\$2.65	180.431	\$1.60
1-1/2	011	1.10	0.0441	—	—	—	—	—	—	—	—	—	—	—	—
1-3/4	0115	1.15	0.04527	—	—	—	—	—	—	—	—	—	—	—	—
2	012	1.20	0.04720	180.372	\$1.50	180.242	\$1.15	—	—	180.402	\$2.65	180.414	\$2.65	180.432	\$1.60
2-1/4	0125	1.25	0.04921	—	—	—	—	—	—	—	—	—	—	—	—
2-1/2	013	1.30	0.0500	—	—	—	—	—	—	—	—	—	—	—	—
2-3/4	01375	1.375	0.05413	—	—	—	—	—	—	—	—	—	—	—	—
3	014	1.40	0.0551	180.373	\$1.50	180.243	\$1.15	—	—	180.403	\$2.65	180.415	\$2.65	180.433	\$1.60
3-1/2	0145	1.45	0.0559	—	—	—	—	—	—	—	—	—	—	—	—
4	015	1.50	0.0591	—	—	180.244	\$1.15	—	—	180.404	\$2.65	180.416	\$2.65	—	—
4-1/2	0155	1.55	0.0622	—	—	—	—	—	—	—	—	—	—	—	—
5	016	1.60	0.0630	180.374*	\$1.50	180.245	\$1.15	—	—	180.405	\$2.65	180.417	\$2.65	180.437	\$1.60
5-1/4	0165	1.65	0.0649	—	—	—	—	—	—	—	—	—	—	—	—
5-1/2	017	1.70	0.0689	—	—	—	—	—	—	—	—	—	—	—	—
5-3/4	0175	1.75	0.0690	—	—	—	—	—	—	—	—	—	—	—	—
6	018	1.80	0.0709	180.375*	\$1.50	180.246	\$1.15	180.277	\$1.05	180.406	\$2.65	180.418	\$2.65	180.439	\$1.60
6-1/2	019	1.95	0.0776	—	—	—	—	—	—	—	—	—	—	—	—
6-3/4	020	2.00	0.0787	—	—	—	—	—	—	—	—	—	—	—	—
7	021	2.10	0.0827	180.376	\$1.50	180.247	\$1.15	180.278	\$1.05	180.407	\$2.65	180.419	\$2.65	180.441	\$1.60
7-1/2	022	2.20	0.0866	—	—	—	—	—	—	—	—	—	—	—	—
8	023	2.30	0.0906	—	—	180.248	\$1.15	180.279	\$1.05	180.408	\$2.65	180.420	\$2.65	180.443	\$1.60
8-1/2	024	2.40	0.0953	—	—	—	—	—	—	—	—	—	—	—	—
9	025	2.50	0.0984	—	—	180.249	\$2.50	180.280	\$3.55	180.409	\$4.95	Fast cut cup burs from Busch® feature a blade design that allows for faster cutting, assuring longer life for the bur and higher production for the jeweler. Germany.	—	180.445	\$3.20
9-1/2	026	2.60	0.1031	—	—	—	—	—	—	—	—		—	180.447	\$3.20
10	027	2.70	0.1063	180.378*	\$2.60	180.250	\$2.50	180.281	\$3.55	180.410	\$4.95		—	180.448	\$3.20
10-1/2	028	2.80	0.1102	—	—	—	—	—	—	—	—		—	—	—
11	029	2.90	0.1141	—	—	180.251	\$2.50	180.282	\$4.90	180.411	\$4.95		—	180.449	\$4.85
11-1/2	030	3.00	0.1181	—	—	—	—	—	—	—	—		—	—	—
12	031	3.10	0.1220	180.379	\$3.00	180.252	\$4.75	—	—	180.412	\$5.95		—	—	—
13	033	3.30	0.1299	—	—	180.253	\$4.75	—	—	—	—		—	—	—
14	035	3.50	0.1378	—	—	180.254	\$4.75	—	—	—	—		—	—	—
15	037	3.70	0.1457	—	—	180.255	\$4.75	—	—	—	—		—	—	—
16	040	4.00	0.1575	—	—	180.256	\$6.00	—	—	—	—		—	—	—
17	042	4.20	0.1654	—	—	180.257	\$4.75	—	—	—	—		—	—	—
18	045	4.50	0.1772	—	—	180.258	\$6.00	—	—	—	—		—	—	—
19	047	4.70	0.1850	—	—	180.259	\$4.75	—	—	—	—		—	—	—
20	050	5.00	0.1968	—	—	180.260	\$4.15	—	—	—	—		—	—	—
22	055	5.50	0.2162	—	—	—	—	—	—	—	—		—	—	—
24	060	6.00	0.2358	—	—	—	—	—	—	—	—		—	—	—
26	065	6.50	0.2554	—	—	—	—	—	—	—	—		—	—	—
28	070	7.00	0.2751	—	—	—	—	—	—	—	—		—	—	—
32	080	8.00	0.3144	—	—	180.266	\$8.60	—	—	—	—		—	—	—

Spearhead High Speed Steel Burs

High speed steel for longer wear and exceptional cutting efficiency. Available in a wide variety of shapes and sizes for cutting most metals. All have 3/32" shanks which fit most flexible shaft handpieces.



Spearhead Bur Sets

Contain the most popular sizes in specific shapes.

No.	Shape	Bur Nos.	Qty.	Price
190.311	Ball	1 to 15	15	\$58.30
190.312	Ball	1 to 30	29	\$132.10
190.313*	Ball	1 to 34	33	\$153.35
190.315	45° Bearing	2 to 28 Assorted	14	\$79.95
190.316	45° Bearing	2 to 34 Assorted	24	\$122.95
190.318	90° Bearing	2 to 28 Assorted	14	\$78.00
190.319	90° Bearing	12 to 34	22	\$172.25
190.321*	Bud	2 to 26 Assorted	19	\$79.60
190.322*	Bud	2 to 34 Assorted	23	\$119.60
190.325*	Cone	2 to 34 Assorted	23	\$105.80
190.333	Stone Setting	1 to 30	29	\$149.15
190.334	Stone Setting	1 to 34	33	\$179.00
190.335*	Stone Setting	1 to 18	18	\$78.75



191.310*

Bergeon 24 Piece Bur Assortment

Various shapes and sizes of the most popular burs for practically every requirement. Swiss made. Bergeon 30008.

191.310* \$112.10



191.850*

Perfection Setting Burs

Set of 30 sizes for cutting stone seats. All have 1/8" shanks. Plastic stand with cover.

191.850* \$190.55

Size	Diameters		Ball	Price	Bearing 45°		Wheel	Price
	MM	Inches			Price	Price		
1	1.05	.040	190.341	\$4.10	—	—	—	—
2	1.20	.050	190.342	\$4.10	190.382	\$4.15	—	—
3	1.35	.053	190.343	\$4.10	190.383	\$4.15	—	—
4	1.50	.059	190.344	\$4.10	190.384	\$4.10	—	—
5	1.70	.067	190.345	\$4.10	190.385	\$4.10	190.745*	\$4.10
6	1.90	.075	190.346	\$4.10	190.386	\$4.10	—	—
7	2.10	.083	190.347	\$4.10	190.387	\$4.55	—	—
8	2.30	.090	190.348	\$4.10	190.388	\$4.55	190.748*	\$4.10
9	2.50	.098	190.349	\$5.35	190.389	\$4.55	—	—
10	2.70	.106	190.350	\$5.35	190.390	\$4.55	—	—
11	2.90	.114	190.351	\$5.35	190.391	\$4.55	—	—
12	3.10	.122	190.352	\$5.35	190.392	\$4.55	—	—
13	3.30	.130	190.353	\$4.95	190.393	\$5.40	190.753	\$5.20
14	3.50	.138	190.354	\$4.95	190.394	\$5.40	—	—
15	3.80	.149	190.355	\$4.95	190.395	\$5.40	—	—
16	4.00	.157	190.356	\$4.95	190.396	\$5.60	190.756	\$5.50
17	4.30	.169	190.357*	\$4.95	190.397	\$5.60	—	—
18	4.50	.177	190.358	\$4.95	190.398	\$5.60	—	—
19	4.70	.185	190.359	\$5.50	190.399	\$5.95	190.759	\$5.65
20	5.00	.197	190.360	\$5.50	190.400	\$5.95	—	—
22	5.20	.204	190.362	\$5.50	190.402	\$5.95	—	—
23	5.40	.212	190.363	\$5.50	—	—	—	—
24	5.60	.220	190.364	\$5.50	190.404	\$5.95	—	—
25	5.90	.232	190.365	\$5.50	—	—	—	—
26	6.30	.248	190.366	\$7.10	190.406	\$7.15	190.766*	\$7.40
27	6.70	.263	190.367	\$7.10	—	—	—	—
28	7.20	.283	190.368	\$7.10	190.408	\$7.15	—	—
29	7.60	.299	190.369	\$7.95	—	—	—	—
30	8.00	.314	190.370	\$8.15	190.410	\$7.70	190.770*	\$8.10
31	8.90	.350	190.371	\$7.90	—	—	—	—
32	9.60	.377	190.372	\$7.90	—	—	—	—
33	10.40	.409	190.373	\$9.45	—	—	—	—
34	11.00	.437	190.374	\$9.45	190.414	\$10.00	190.774*	\$10.70

Bur & Drill Lubricant on page 147 or 248.

GROBET USA™ Rotary Files

High speed steel. Cylinder shape for all purpose applications and inside of rings. Two cuts, various sizes, all 1/2" Head Diameters.

No.	Length of Cut	Cut	Shank Diameter	Price
331.629	1"	Standard	3/32"	\$39.95
331.630	1"	Fine	3/32"	\$96.50
331.631	1 1/2"	Standard	3/32"	\$29.95
331.632*	1 1/2"	Fine	3/32"	\$69.95
331.635*	1"	Standard	1/8"	\$39.95
331.636*	1"	Fine	1/8"	\$63.50
331.637*	1 1/2"	Standard	1/8"	\$32.95
331.638*	1 1/2"	Fine	1/8"	\$81.00

331.629 - 331.638*



201.290 201.291 201.293



GROBET USA™ Inside Ring Burs

Carbide steel for extra long life. Size, shape and cut are designed for fast deburring, smoothing and finishing of inside ring surfaces.

No.	Head Diameter	Head Length	Shank Diameter	Finish	Price
201.290	1/2"	1"	1/4"	Extra Fine	\$38.95
201.291	1/2"	1"	1/4"	Fine	\$44.15
201.293	1/4"	5/8"	1/8"	Fine	\$23.75

200.292



Cas-Ker Inside Ring Bur

Tungsten Carbide - Longer lasting and faster cutting than high speed steel. Fine Finish, 3/4" long, 3/8" diameter, 1/8" shank.

200.292 \$24.95



201.01401

201.01402

201.01403

VIGOR® Inside Ring Burs

Designed for deburring, smoothing and finishing of inside ring surfaces. Carbide steel for extra long life and an exact cutting.

No.	Head Diameter	Head Length	Shank Diameter	Finish	Price
201.01401	1/4"	1/2"	3/32"	Fine	\$21.40
201.01402	1/4"	1/2"	3/32"	Extra Fine	\$21.40
201.01403	1/4"	1/2"	3/32"	Extra Coarse	\$21.40
201.01404*	3/8"	3/4"	1/8"	Fine	\$36.75
201.01405*	3/8"	3/4"	1/8"	Extra Fine	\$36.75
201.01406*	3/8"	3/4"	1/8"	Extra Coarse	\$36.75

Diamond Points on 3/32" Shanks

Highly effective for fine detail work and carving of all types. Exceptionally long lasting. Use with a light touch at 10,000 RPM.

No.	mm	I.S.O. Size	Description	Price
111.126	1.3	013	Round	\$17.30
111.127*	8.3	083	Inverted Wide Cone	\$19.90
111.128*	3.5	035	Flat and Cylinder	\$20.55
111.129*	2.3	023	Inverted Cone	\$16.60
111.130*	6.3	063	Square Edge Wheel	\$18.95
111.131*	3.8	038	Cone Square	\$16.80
111.132	5.2	052	Tapered Cone	\$16.80
111.133	1.8	018	Narrow Cone	\$16.60
111.134*	2.9	029	Round	\$12.65
111.136	2.4	024	Cone	\$16.60
111.137*	7.3	073	Tapered Wheel	\$16.60

111.126



111.127



111.128*



111.129*



111.130*



111.131*



111.132



111.133



111.134*



111.136



111.137*





Size	Diameters		90° Bearing	Bud	Cone	Cylinder	Inverted Cone	Setting	Slim Reamer	Flame
	MM	Inches								
1	1.05	.040	190.421 \$3.95	—	—	—	—	190.671 \$4.10	—	—
2	1.20	.050	190.422 \$3.95	190.462 \$3.30	190.522* \$3.20	—	—	190.672 \$4.10	—	190.802* \$4.15
3	1.35	.053	190.423 \$3.95	190.463 \$3.30	190.523* \$3.35	—	—	190.673 \$4.10	—	—
4	1.50	.059	190.424 \$4.10	190.464 \$3.15	190.524* \$3.35	—	—	190.674 \$4.10	—	—
5	1.70	.067	190.425 \$4.10	190.465 \$3.15	190.525 \$3.40	190.565 \$4.00	190.635 \$3.95	190.675 \$4.20	—	—
6	1.90	.075	190.426 \$4.10	190.466 \$3.30	190.526* \$3.40	—	—	190.676 \$4.20	—	190.806* \$4.15
7	2.10	.083	190.427 \$4.15	190.467 \$3.30	190.527 \$3.50	—	—	190.677 \$4.20	—	—
8	2.30	.090	190.428 \$4.05	190.468* \$3.40	190.528* \$3.50	190.568 \$4.00	190.638 \$3.95	190.678 \$4.20	—	190.808* \$4.15
9	2.50	.098	190.429 \$4.35	190.469* \$3.50	190.529* \$3.35	—	—	190.679 \$4.45	—	—
10	2.70	.106	190.430 \$4.35	190.470* \$4.00	190.530* \$3.50	—	—	190.680 \$4.45	—	—
11	2.90	.114	190.431 \$4.35	190.471* \$4.00	190.531 \$4.00	—	—	190.681 \$4.45	—	—
12	3.10	.122	190.432 \$4.55	190.472* \$4.00	190.532* \$3.50	—	—	190.682 \$4.95	—	190.812* \$4.75
13	3.30	.130	190.433 \$5.05	190.473* \$4.15	190.533* \$4.15	190.573 \$6.45	190.643 \$7.50	190.683 \$5.05	190.713 \$5.40	—
14	3.50	.138	190.434 \$5.05	190.474* \$4.15	190.534* \$4.15	—	—	190.684 \$5.05	—	190.814* \$5.20
15	3.80	.149	190.435 \$5.05	—	—	—	—	190.685 \$5.05	—	—
16	4.00	.157	190.436 \$5.40	190.476* \$4.80	190.536* \$4.90	190.576 \$6.60	—	190.686 \$5.30	—	190.816* \$5.45
17	4.30	.169	190.437 \$5.40	—	—	—	—	190.687 \$5.30	—	—
18	4.50	.177	190.438 \$5.40	190.478* \$4.80	190.538* \$4.15	—	—	190.688 \$6.00	—	190.818* \$5.45
19	4.70	.185	190.439 \$5.75	—	—	190.579 \$7.30	190.649 \$7.15	190.689 \$6.25	190.719 \$6.00	—
20	5.00	.197	190.440 \$6.45	190.480 \$5.55	190.540* \$5.15	—	—	190.690 \$6.45	—	190.720* \$6.15
22	5.20	.204	190.442 \$6.90	190.482* \$5.70	190.542* \$5.15	—	—	190.692 \$6.45	—	190.722* \$6.15
23	5.40	.212	190.443 \$6.90	—	—	—	—	190.693 \$6.45	—	—
24	5.60	.220	190.444 \$6.90	190.484 \$5.70	190.544* \$5.15	—	—	190.694 \$6.45	—	190.724* \$6.15
25	5.90	.232	191.445 \$6.50	—	—	—	—	190.695 \$6.45	—	—
26	6.30	.248	190.446 \$6.50	190.486 \$6.30	190.546* \$6.40	190.586* \$8.80	190.656 \$6.80	190.696 \$7.20	—	190.726* \$7.35
27	6.70	.263	190.447 \$6.50	—	—	—	—	190.697 \$7.30	—	—
28	7.20	.283	190.448* \$7.50	190.488 \$6.30	190.548* \$6.40	—	—	190.698 \$7.30	—	—
29	7.60	.299	190.449 \$7.50	—	—	—	—	190.699* \$7.50	—	—
30	8.00	.314	190.450* \$8.80	190.490* \$7.45	190.550* \$6.40	190.590* \$9.50	190.660 \$7.45	190.700 \$7.85	—	190.730* \$7.95
31	8.90	.350	190.451* \$8.35	—	—	—	—	190.701* \$8.75	—	—
32	9.60	.377	190.452 \$8.40	190.492* \$8.00	190.552* \$7.15	—	—	190.702 \$8.75	—	—
33	10.40	.409	190.453 \$9.15	—	—	—	—	190.703 \$9.15	—	—
34	11.00	.437	190.454* \$8.85	190.494* \$8.60	190.554* \$7.90	190.594 \$9.70	—	190.704 \$9.15	—	—

DIXON® Carbide Burs

Once you try these you'll never use old fashioned steel burs again. Long-lasting carbide combined with the technique of alternate diamond cutting on most burs provides benefits never before possible. Shanks are 3/32".

See illustrations for stock numbers and prices.

- Long tool life
- Maximum control
- Minimal clogging
- Fast material removal
- Smooth cutting
- Reduced vibration
- Minimum heat



530.195

PavéTron™ Diamond Tip Pave Finish Tool

Produce a sparkling pave style finish with minimum effort and with no learning time. Adds a luxurious texture and sparkle to gold and silver jewelry. Fits all hammer handpieces. Diamond cutting head gives the perfect cut. Made in USA.

530.195

\$21.95

201.205* \$17.10

201.208* \$15.10

201.214* \$21.55

201.217* \$14.70

201.221* \$16.80

201.224* \$24.95

201.227* \$19.95

201.230* \$19.75

201.233* \$15.35

201.236* \$24.95

201.239* \$21.00

201.242* \$19.20

201.245* \$12.15

201.248* \$12.15

201.251* \$13.70



Margin Roller/Burnisher

For burnishing scratches from gold, making it possible to salvage many pieces without gold loss. The 3/16" head consists of five steel rollers that act as rotating mallets. 3/32" shank for handpiece.

181.080

\$23.25



181.080

Porosity Killer

Hammer metal (gold, silver, platinum, etc) into minor porosity holes in castings, eliminating the need for extra filing and filling of holes with solder. Works at high speed in flex-shaft. 3/32" shank.

211.05600

\$16.75



211.05600

Diamond Flywheels

Create interesting, unusual, and beautiful jewelry designs. Use with a high-speed handpiece up to 35,000 rpm to form cuts for setting stones, backgrounds, etc. Finest grade 2mm diamond set in steel, 4mm shaft, 1 1/2" long. Shank is 5/32". No warranty. We cannot accept returns on these flywheels.

110.090 120° Angle \$71.70

111.091 120° Angle 3mm Shank \$82.50

110.092* 130° Angle \$71.70

110.094 150° Angle \$82.50

110.096* Flat \$82.50



110.090 -
110.096



190.201



190.800

Magnetic Bur Stand

Keep the burs you use most close at hand with this little stand. Plastic base with internal magnet holds a total of 40 burs, drills or polishers. 2¹/₄" diameter, 2¹/₄" high.

190.800

\$13.25

Rotating Bur Organizer

This organizer rotates 360° on ball bearings for fast, smooth bur selection. Holds 150 of your burs, brushes, drills, etc. Made of sturdy plastic in the USA.

190.201

\$15.75

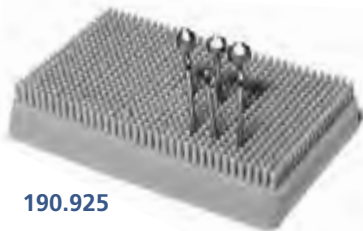

190.925



151.0375

Plastic Bur Stand

Handy holder helps keep 3/32" shank burs in place, safe from loss or damage. 5" x 3" x 1".

190.925

\$4.95

Wood Box Protects Your Burs

Protects burs and keeps them handy at all times.

151.0375

\$13.65

Handy storage for bur packs

Most jewelers and setters prefer to leave burs in the plastic boxes for easy identification. This box has 15 compartments to hold small and large packages and has removable dividers which keep boxes upright to easily identify. Wood, measures 8" x 6" x 1¹/₂".

180.000

\$10.25



180.000

Bur Stand with Cover

Plastic stand with clear cover stores 34 - 3/32" and 18 - 1/8" shank accessories. Measures 2¹/₂" square by 2¹/₄" high. Holds burs up to 2" long. (Burs not included).

190.202

\$3.95



190.202

20 Twist Drills in Plastic Stand

A variety of one each drill size 61 to 80. Convenient plastic stand with clear domed lid. Sizes stamped on stand for easy selection and storage of proper drill size.

280.502

\$29.95



280.502

Set of 20 High Speed Twist Drills

High speed steel. Handy drill index offers sizes 61 to 80 for fine jobs. All drills are marked by size, finely ground and heat-treated to a Rockwell hardness of 63. Metal case.

280.501

\$10.95



280.501

Set of 200 High Speed Steel Drills

Quality European made HSS twist drills in a handy organizer. Set includes ten each, sizes 61-80 in convenient tubes and a hardwood stand marked with the appropriate sizes. Store, replenish and retrieve with ease.

280.457

\$104.50



280.457



281.350
281.351
281.352

Mascot® Flat Pivot Drill Assortments

Contains one dozen carbon steel drills in even numbers only. Comes in wood block, marked with sizes, with clear plastic, protective cover.

281.350	Sizes .004" to .010" (three of each)	\$62.95
281.351	Sizes .004" to .026" (one of each)	\$65.00
281.352*	Sizes .028" to .050" (one of each)	\$56.00

Mascot® Flat Pivot Drills

Carbon steel for drilling brass, mild steel, aluminum, etc. Right hand with rake angle of zero degrees. Shank diameter for sizes .004" to .026" is 1 mm, and for sizes .028" to .050" shank is 1.5 mm. Individual sizes, sold by the dozen only, special order.

No.	Drill Size	Dozen	No.	Drill Size	Dozen
281.364	.004"	\$50.70	281.388*	.028"	\$44.25
281.366*	.006"	\$50.70	281.390*	.030"	\$42.10
281.368*	.008"	\$47.00	281.392*	.032"	\$44.25
281.370	.010"	\$48.25	281.394*	.034"	\$44.25
281.372*	.012"	\$44.70	281.396*	.036"	\$44.25
281.374*	.014"	\$44.70	281.398*	.038"	\$45.75
281.376*	.016"	\$44.70	281.400*	.040"	\$43.50
281.378*	.018"	\$44.70	281.402*	.042"	\$45.75
281.380*	.020"	\$42.50	281.404*	.044"	\$45.75
281.382*	.022"	\$44.70	281.406*	.046"	\$45.75
281.384*	.024"	\$44.70	281.408*	.048"	\$45.75
281.386	.026"	\$44.70	281.410*	.050"	\$43.50



280.507

Diamond Coated Drills

These twist drills with electroplated diamond particles are the ultimate for drilling stones, pearls, glass or ceramics. Use with standard hand pieces and a small amount of water as lubricant. Grit 140/170. Set includes six drills, diameters: 1.00, 1.30, 1.40, 1.60, 1.80, and 2.10mm. Shanks are 2.35mm.

280.507 **\$49.95**



Mascot® High Speed Steel Twist Drills

An outstanding combination of precision, durability and economy. Individual sizes, sold in packs of 10.

No.	Drill Size	(in)	(mm)	B & S Gauge	Pack of 10
281.530	30	.1285"	3.2639	—	\$8.60
281.532	32	.1160"	2.9464	—	\$8.60
281.533*	33	.1130"	2.8702	—	\$8.60
281.534	34	.1110"	2.8194	—	\$8.60
281.536	36	.1065"	2.7051	—	\$8.60
281.538	38	.1015"	2.5781	—	\$8.60
281.540	40	.0980"	2.4892	—	\$8.60
281.541	41	.0960"	2.4384	—	\$10.40
281.542	42	.0935"	2.3749	—	\$10.40
281.543	43	.0890"	2.2606	—	\$9.75
281.544	44	.0860"	2.1844	—	\$9.75
281.545	45	.0820"	2.0828	—	\$9.75
281.546	46	.0810"	2.0574	12	\$9.75
281.547	47	.0785"	1.9939	—	\$9.75
281.548	48	.0760"	1.9304	—	\$9.75
281.550	50	.0700"	1.7780	—	\$8.35
281.551	51	.0670"	1.7018	—	\$8.35
281.552	52	.0635"	1.6129	—	\$8.35
281.553	53	.0595"	1.5113	—	\$8.35
281.554	54	.0550"	1.3970	—	\$8.35
281.555	55	.0520"	1.3208	—	\$9.50
281.556	56	.0465"	1.1811	—	\$8.35
281.557	57	.0430"	1.0922	—	\$8.35
281.558	58	.0420"	1.0668	—	\$8.35
281.559	59	.0410"	1.0414	—	\$8.35
280.560	60	.0400"	1.0160	18	\$8.35
280.561	61	.0390"	0.9906	—	\$8.35
280.562	62	.0380"	0.9652	—	\$8.35
280.563	63	.0370"	0.9398	—	\$8.35
280.564	64	.0360"	0.9144	19	\$8.35
280.565	65	.0350"	0.8890	—	\$8.35
280.566	66	.0330"	0.8382	—	\$8.35
280.567	67	.0320"	0.8128	20	\$8.35
280.568	68	.0310"	0.7874	—	\$8.35
280.569	69	.0292"	0.7417	—	\$8.35
280.570	70	.0280"	0.7112	21	\$8.35
280.571	71	.0260"	0.6604	—	\$8.35
280.572	72	.0250"	0.6350	22	\$8.35
280.573	73	.0240"	0.6096	—	\$8.35
280.574	74	.0225"	0.5715	23	\$8.35
280.575	75	.0210"	0.5334	—	\$8.35
280.576	76	.0200"	0.5080	24	\$8.35
280.577	77	.0180"	0.4572	25	\$8.35
280.578	78	.0160"	0.4064	26	\$8.35
280.579	79	.0145"	0.3683	27	\$8.35
280.580	80	.0135"	0.3429	—	\$8.35

Mascot® High Speed Drill Assortment

Set of 6 high speed steel assorted sizes 30 to 52 in plastic tube.

281.500 **\$6.75**



281.504



281.503

Set of 12 Grobet High Speed Twist Drills

Contains sizes 50 to 61 in wood block.

281.503

\$22.60

Set of 36 Grobet High Speed Twist Drills

Contains sizes 33 to 80 in wood stand.

281.504

\$57.75

Busch Twist Drill Assortment

Twelve of the most popular sizes tungsten vanadium steel twist drills. 3/32" shanks.

280.583

\$28.00



280.583



280.456

Tungsten Carbide Drills

100% hard metal for jewelers. Ideal for drilling glass, ceramic, bone, jade, mother-of-pearl as well as various metals, including stainless steel. Set of 10 popular diameters. 3/32" (2.35mm) shanks. Finest quality. European made.

280.456

\$103.50

Refills:

280.456.005	280.456.008	280.456.011	280.456.013
280.456.006	280.456.009	280.456.012	280.456.014
280.456.007	280.456.010		

Above Refills

\$10.95 ea



280.584 - 280.596



280.455

Individual Busch Twist Drills

Individual drills, minimum order six pieces per size. 3/32" shank. Made in Germany.

No.	ISO	mm	No.	ISO	mm	No.	ISO	mm
280.584	005	.50	280.589	010	1.00	280.594	018	1.80
280.585	006	.60	280.590	012	1.20	280.595	021	2.10
280.586	007	.70	280.591	014	1.40	280.596	023	2.30
280.587	008	.80	280.592	015	1.50			
280.588	009	.90	280.593	016	1.60			

Busch Twist Drills (6 minimum)

\$2.75 ea

30 Twist Drills

Assortment of 30 (10 each of 3 sizes) twist drills. Sizes 0.60, 0.80, 1.00mm.

280.455

\$21.95

Benchtop Drill Press

This easy-to-use benchtop drill press is tiny, but powerful enough to use for all of your drilling projects. With a platform measuring only 6 3/4" x 6 3/4", it is space-saving as well as economical. Variable speed up to 8,500 RPM. One year warranty.

280.001

\$83.95

Drill Press Vise with mounting hardware

This handy aluminum vise is great for use with a tabletop drill press like our 280.001. The slots and included hardware make it easy to attach to a drill press base. Its quick release button permits rapid opening and closing of the jaws, or use the handle to make smaller adjustments. Jaws are 2 1/2" wide x 1 1/16" high. Maximum jaw opening is 2 3/4". Overall dimensions 9 1/2" long x 4 1/4" wide.

580.009

\$13.75



280.001



580.009

Pearl Drill Set

Set of 12 drills in wood stand with cover for drilling holes for setting seed pearls and other round or half-round stones. Sizes 1.05 - 3.00 mm, 1/8" shanks.

531.120* **\$110.95**

Individual Drills:

No.	Diam	No.	Diam	No.	Diam
531.121*	1.05	531.127*	2.05	531.131*	2.83
531.122*	1.20	531.128*	2.26	531.132*	3.00
531.125*	1.65	531.124*	1.45		
531.126*	1.85	531.129*	2.40		

\$8.75 each

Micro Twist Drills

20 piece set of jewelers' twist drills, wire gauge sizes 61 - 80.

280.505 **\$23.75**

Center Chuck Spiral Drill

Push center chuck to rotate drill. Capacity 0 to 1/32". Length 4".

281.230 **\$10.25**

Spiral Drills

Pushing handle rotates drill. Capacity 1/16". Length 7 3/4".

281.234* **\$7.10**

Handy Adapter Chucks

For holding small drills in larger chucks or flexshaft handpieces. 3/32" shanks

280.214 3 Collets 0-2.50 Cap. **\$8.95**

281.215 1 Collet 0-1.15 Cap. **\$8.90**

281.216 2 Collets 0-2.50 Cap. **\$13.25**

281.217* 2 Collets 0-2.90 Cap. **\$12.25**

Hand Drill

Smooth operating drill with adjustable chuck. Sturdy tool for all-around use. 11" long, 3/16" capacity.

281.233 **\$23.10**

Pearl Holder

Ideal for drilling pearls. Securely holds pearls up to 8mm.

531.0660 **\$13.95**

Pearl and Bead Holder for Drilling

The ultimate for fully drilling pearls and other drillable beads. Partially drill through pearls and clean out obstructed holes with ease. Use your flex-shaft and a #60 (1.00mm) drill. Metal frame with nylon dies holds pearls without damage.

280.000 **\$14.50**

Bur & Blade Lubricant

Keeps burs, drills, sawblades and gravers working smoother and longer. Reduces heat and friction to speed the cut. Push-up tube.

191.928 **\$5.25**

Carbide Rod for Making Poising Drills

Round carbide rod can be shaped into poising drills. Exceptional hardness, not easily breakable and it won't dull. 1 1/2" x 1/32".

280.460 **\$16.95**



531.120*



280.505



281.230



281.234



280.214



281.233*



531.0660



280.000



191.928



280.460

Miniature Mandrels

Designed for use with flexible shaft units and drill presses, etc. Small felt cones, felt cylinders, rubberized abrasives and grinding wheels are but a few of the many types of accessories that can be mounted on these mandrels. All are nickel-plated steel unless noted. Mandrels and mounted accessories used improperly are dangerous. Comply with American National Standards Institute Safety Code B7.1 and Occupational Safety and Health Act covering: speed, safety guards, flanges, mounting procedures, general operating rules, handling, storage and inspection. The correct usage speed depends on the accessory being used.

Mandrels with 3/32" Shanks



General Mandrel

Used to adapt most accessories having a 1/8" shank. Sold by the dozen.

431.140 \$38.25 dozen



Mandrels for Wheels

Use with wheels having 1/16" arbor holes.

SKU	Washer	Material	Per Dozen
431.130	No	Steel	\$9.95
431.132	Yes	Nickel-plated	\$11.10
431.134	Yes	Stainless steel	\$19.90



Mandrel with Reinforced Screw

431.128 \$14.25 dozen
431.128.01 \$1.50 each



Steel Threaded Mandrel

With brass collar. 3/32" shank. Used with rubber points.

431.126 \$11.95 dozen



Threaded Mandrel

Popular for use with Cratex rubberized abrasives.

431.124 \$13.40 dozen



Tapered Thread Mandrel

431.120 3/16" screw length \$7.50 dozen
430.122* 3/8" screw length \$7.50 dozen

Mandrels with 1/8" Shanks



Grinding Wheel Mandrels

1/8" shank with washers. 1/8" arbor is ideal for Cratex rubberized abrasives.

431.160 For 1/8" arbors \$15.30 dozen

431.160.1 For 1/8" arbors \$1.70 each

431.164 For 1/4" arbors \$22.95 dozen



Mandrels for Wheels

Will fit wheel sizes up to those listed. No.431.158 is ideal for use with Cratex rubberized abrasives. Sold by the dozen.

SKU	Wheel Diam.	Wheel Thickness	Hole Size	Per Dozen
431.158	1"	1/4"	1/16"	\$14.30
431.162	1"	1/4"	1/8"	\$16.80



Reinforced Screw Mandrel

431.156 \$14.50 dozen



Threaded Mandrel

Popular for use with Cratex rubberized abrasives. Sold by the dozen.

431.154 \$10.25 dozen



Tapered Thread Mandrels

431.150 3/16" screw \$8.95 dozen

431.152 3/8" screw \$9.45 dozen

Mandrels with 1/4" Shanks



Threaded Mandrel

Popular for use with Cratex rubberized abrasive cones.

431.166 \$4.85



Mandrel for Grinding Wheels

Will fit wheels with 1/4" hole size, up to 3" in diameter and 1/2" thick. Popular for use with Cratex rubberized abrasives.

431.168 \$7.90



Hippie Mandrel

The ideal mandrel to give extra durability and finer performance to all fragile separating discs. 3/32" shank.

430.542 \$2.50



Wood Mandrels with Metal Threaded Ends

Fit on tapered spindles of polishing motors. Convenient way to mount and change smaller brushes.

471.258 Right \$5.10

471.259 Left \$5.10

Freedom TX . . . the most advanced flexible shaft technology provides the ultimate in performance in all bench jeweler applications.

High Torque at All Speeds

From start up to full speed the TX 1/3 Horsepower motor delivers more torque with complete control than any other flexible shaft power tool...even more than Freedom Series H or R motors. Smooth, controlled acceleration up to 15,000 RPM. More control

of the cutting tool, drill, or bur under any load plus the highest speeds you need for a complete range of buffing, polishing, and grinding applications. The ultimate power tool for the stone setter using burs or hammer handpiece, and for general work.

- Permanent magnet DC motor with 1/3 Horsepower continuous duty rating for maximum power and efficiency. The latest in electric motor design and performance.
- Includes the TXR Foot control with solid state electronic circuit board. (The TX motor must be used only with this control).
- Heavy duty low profile housing. Hang-up style motor.
- Standard flexible shaft for connection to all Freedom "QD" style handpieces including Nos. 10, 15, 18, 28, 30[®], 35, 44T, 52 and all their duplex connection versions.
- Two Year Warranty.

340.005 **\$279.95**

340.347 Replacement Freedom TXR Foot Control **\$57.95**

FOREDOM[®]

Freedom All Purpose Kit with 1/6 HP Model SR Reversible Ball Bearing Motor

Contains the powerful machine, popular foot control and handpiece for the professional craftsman.

- 1/6HP Series SR with ball bearing motor and higher 18,000 RPM.
- FCT heavy duty solid state foot control for extra smooth variable speed from low to full speed and no heat build up.
- Attached motor hanger and utility hook for wall mounting.
- No.30 ball bearing handpiece with Jacobs chuck and key. 5/32" chuck capacity.
- FREE No.21 Accessory Kit, AT-1 Accessory Tray, tube of grease.
- Motor and control carry a two year warranty.

340.224 **a \$397.00 value for just \$314.95**



340.005

This is the best motor and control to use with the No.30[®] and No.35 hand-pieces, AllSet™ Stone Setting Guide, drill presses, as well as all other Freedom jeweler handpieces.



340.224

Accessory Kit FREE with purchase!



1/4 HP
340.000



1/4HP Flexible Shaft Machine

This economical workhorse is perfect for cleaning, polishing, sanding, drilling and much more. Fully interchangeable unit with standard style handpiece. Variable speed: 500 - 15,000 - 22,000 RPM. Standard 5/32" (4mm) chuck and variable speed foot control. Comes in durable hard case.

340.000

\$99.75

Grobet Premium Flexible Shaft

Grobet Series C-300 Jeweler's Flexshaft Kit.

- Premium Quality - Precision Built.
- 1/10HP Ball Bearing Motor. Maximum 18,000 RPM.
- Jeweler's Handpiece with Jacob's Chuck and Key.
- Smooth operating Foot Control.
- One Year Warranty.

341.300 Grobet Flexible Shaft Kit

\$99.00

341.367 Jeweler's Handpiece only

\$38.95

Flexible Shaft Lubricant

Foredom recommends lightly lubricating the shaft after every 50 hours of use. 1 fluid ounce tube.

340.334

\$3.95



1/10HP

341.300



ARBE

1/4HP

ARBE 1/4HP Pro-Flex System "Power...Delivered"

- 1/4 HP. 0-20,000 RPM. 110V.
- Variable Speed Foot Control.
- Includes Jewelers' Handpiece.
- Motor Hanger
- One Year Warranty.
- Made in USA.

340.015

\$229.95



340.015

Freedom Flex-Shaft Handpieces

Freedom Handpiece with Press-to-Release Collet

Unique QuickChange handpiece features a thumb lever action collet release mechanism for easy and rapid accessory change.

- Faster bur changing for improved productivity.
- Ideal for stone setters and jobs requiring many bur changes.
- Push lever down to open collet. Release lever to lock in bur.
- Permanently lubricated ball bearings for cool, quiet operation and continuous duty.
- For 3/32" shank accessories. Made in the U.S.A.

340.228 Freedom #18 Handpiece	\$153.95
340.229 Freedom #18D w/Duplex Spring**	\$176.50

Freedom Quick Change Handpiece

The handpiece for professional jewelers. This ball bearing, quick change handpiece runs cool and true. Quick release lever facilitates rapid accessory changes. 3/32" shank size only. 3/4" diameter, 7 1/4" long. Weight 4 oz. Fits any flex-shaft machine.

340.237 Freedom #10	\$249.00
340.238 Freedom #10D w/Duplex Spring**	\$271.95

Freedom #20D Quick Change with Duplex Spring

#20D fits snugly and comfortably in the hand followed by the duplex spring that curves and flexes to give you maximum freedom of movement. Pre-lubricated ball bearings. Lever action for fast and easy tool changes.

340.240	\$109.25
----------------	-----------------

Freedom Hammer Handpieces

Greater durability, comfort, and versatility for the professional jeweler and craftsman. 1/32" stroke with adjustable impact and comes with an anvil point for stone setting. Carbide tipped pointed stylus is also available for scribing hardened steel and for light engraving. Duplex spring model offers extra flexibility. 9 1/2" long. 1/2" diameter. Cannot be used with a 1/4 HP motor.

340.231 Freedom #15 Handpiece	\$132.25
340.235 Freedom #15D with Duplex Spring**	\$158.75

Freedom #8 Slim Handpiece

Standard model with pre-lubricated ball bearings for sustained operation at high speed. Easy to change accessories. 3/32" collet supplied.

340.233*	\$79.00
-----------------	----------------

Freedom #30 Jeweler's Handpiece

Freedom's most popular handpiece for all around use. Chuck takes any size accessory shank or drill bit up to 5/32" diameter. Prelubricated ball bearings. 1" diameter, 5 1/4" long with chuck key.

340.236	\$71.50
----------------	----------------



FOREDOM®

**Freedom Handpieces are covered under a 90 day warranty. Duplex Springs are not covered under warranty.

Flex-Shaft Foot Speed Controls

Varies speed from low to full speed. All controls have a one year warranty. These controls are recommended for use with Series S, SR, CC, EE and F models. Series H and R models have controls of their own.



340.328

FOREDOM



340.324



340.323



340.611



340.392



341.290



340.394

Foredom #SCT-1 Electronic Foot Control - Metal Housing

Solid state control. Use with all flex-shafts except full torque model.

340.328 110 volt **\$66.25**

Foredom #FCT-1 Electronic Foot Control - Plastic Housing

Solid state control. Use with "R" series full torque flexshafts.

340.324 110 volt. **\$36.75**

Models for use with all flex-shafts except full torque model.

340.326 110 volt. **\$45.75**

340.326X* 220 volt. **\$45.75**

* *Special Order. Please allow 5-7 business days for delivery.*

Deluxe Foot Control

Deluxe aluminum foot control for variable speed flexible shafts.

340.323 **\$55.25**

Flex-Shaft Holder

Adjustable holder attaches to bench and adjust from 26" to 41". Swivels for easy flex-shaft use.

340.611 **\$20.50**

Handpiece Grip

Rubberized, non-slip grip provides a layer of cushioning between hand and tool, for a more comfortable and more secure grip. For Foredeom #30, SKU 340.236 on page 151.

340.392 **\$2.25**

Jiffy Jig

Polyethylene holds handpiece securely in vise, horizontally or vertically leaving hands free. Accepts other tools of same diameter as handpiece. For Foredeom #30, SKU 340.236.

341.290 **\$17.50**

Foredom Handpiece Rest

Slip this handy item onto your motor hanger and secure your handpiece when not in use. Cut-out conveniently holds a motor cord away from work.

340.394 **\$10.50**



280.211



281.212

Chuck Keys for Handpieces

Makes changing tools quicker and easier. For standard handpieces.

281.212 Key with Handle **\$10.05**

280.211 Key **\$5.25**

Flex-Shaft Accessories

Drill Press Vise with mounting hardware

This handy aluminum vise is great for use with a tabletop drill press like our 280.001. The slots and included hardware make it easy to attach to a drill press base. Its quick release button permits rapid opening and closing of the jaws, or use the handle to make smaller adjustments. Jaws are 2½" wide x 1¼" high. Maximum jaw opening is 2¾". Overall 9½" long x 4¼" wide.

580.009

\$13.75



580.009

Foredom Bench Vise Pads securely hold your handpiece

Magnetic strips hold Soff Jaws™ to your bench vise. Cushioned pads grip odd or round shapes, threaded parts and prevent marring of finished surfaces. Soff Jaws are 3½" wide and fit best on 3", 3½" and 4" wide vises, but can be mounted on larger vises. Soff Jaws are made with resilient ethylene vinyl acetate pads.

580.008

\$10.95



580.008

Foredom Precision Mini-Vise

Zinc die cast mini-vise firmly grasps small workpieces for precision drilling on your bench. Vise has horizontal and vertical "V" grooves for holding small round pieces. Jaw width 1⅜". Jaw capacity 1¼".

580.003

\$29.95



580.003

Collet for Foredom Handpieces

Collet for Foredom #10D handpiece (see SKU 340.238 on page 151).

340.399

\$59.25



340.399

Adapter Chuck

For holding small drills in larger chucks or handpieces. 3/32" shank and 3 collets hold 0 to 2.5mm drills.

280.214

\$8.95



280.214

Anvil Point

For handpiece Nos. 15 and 15D (SKUs 340.231 and 340.235).

340.232

\$6.25



340.232



470.115

Benchtop Polisher

Features pre-lubricated ball bearings and a dust-proof motor housing that makes it virtually maintenance-free.

- Works with standard wheels and buffs up to 4".
- Includes 2 tapered spindles, 2 medium abrasive wheels, 2 replacement motor brushes and screws for bench mounting.
- Variable speed from 1,800 - 7,500 RPM.

470.115

\$92.50

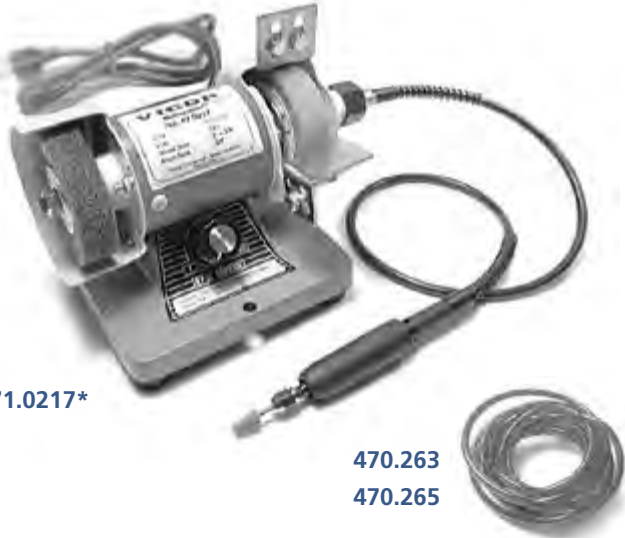

471.0217*

470.263

470.265

VIGOR® Multi-Grinder

Multi-purpose 1/8 HP machine, with variable speeds from 1500 to 4000 RPM, can be used as a carver, grinder, sander, polisher, cutter, buffer, etc. Compact, powerful 36" long flexible shaft and handpiece accepts accessories with 3/32" or 1/8" shafts. Equipped with two 3" x 3/4" grinding and polishing wheels. Can be bolted to your bench for greater stability.

7"W x 4 3/4"D x 6 1/2"H.

471.0217*

\$169.95

Accessories:

171.01220 Extra fine Muslin Buff \$3.95

171.01221 Cotton Flannel Buff \$4.50

171.01222* Felt Buff \$13.95

471.0806* Replacement Grinding Wheel \$8.40

471.0807* Replacement Polishing Wheel \$8.40

Lathe Belting

470.263 3 mm thick x 1 meter (approx. 3 ft.) long \$5.50

470.265 5 mm thick x 1 meter (approx. 3 ft.) long \$5.50

Flexshaft Maintenance Parts



Motor Brushes

Grobet - work for 341.300 and all Grobet/Vigor Flex-Shafts

341.377 \$13.15 pr

Foredom "R" or "CC" series

340.387 \$9.10 pr

Foredom "EE" series

340.388 \$9.95 pr

Foredom "S" series

340.395 \$9.25 pr

Foredom "TX" series

340.398 \$12.25 pr



Motor Brush Caps

340.381 \$1.75 ea



Inner Springs

For Grobet Handpiece 341.247

341.247029* \$43.50



Foredom Motor Connector

340.390 \$4.40



Cable Shafts and Sheaths

For Foredom CC or R series. 341.360 also works for Grobet 341.300 (C-300).

341.360 Shaft \$14.95

341.370 Sheath \$16.50

For Foredom EE series

341.371 Shaft \$15.50

341.361 Sheath \$11.60



Shaft Connector - Foredom #46

340.386 \$4.75



Retaining Ring for Duplex Spring

340.382 \$1.75



Duplex Springs

340.385 Pfinger #311-8 \$13.25

340.380 Foredom #76 \$13.25

Value Series Precision Pliers

Patterned after precision pliers costing much more, these are ideal for any craftsperson who needs usable pliers at reasonable prices. Made for comfort and durability, they feature PVC grips, double-leaf springs, box-joint construction. Inexpensive, but the best buy anywhere in this price range.

Chain Nose

Features smooth jaws with slightly beveled edges to avoid marring. The nose is tapered to a fine point. 5" long.

460.406 **\$7.75**

Flat Nose

Allows you to grip flat objects and make right angle bends. The smooth jaws come to a fine even taper. 4 1/2" long.

460.402 **\$7.75**

Round Nose

Make loops and round bends with the perfectly round and finely tapered tips on this plier. 5" long.

460.404 **\$7.75**

Side Cutter

Semi-flush side cutter is well made for normal jewelry applications. 4 1/2" long.

460.410 **\$8.75**

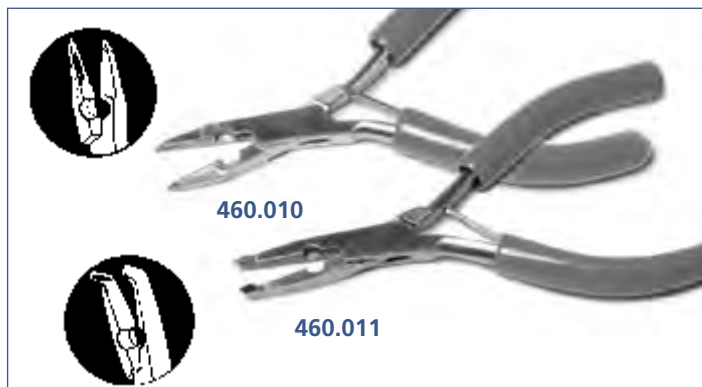

Miracle Point® Pliers are ideal for all your fine work

Feature hand sharpened precision tips with a super grip. Stainless steel with box joints, cushioned handles, and both have a cutter. Straight pointed or bent nose. 4 1/2" long. USA.

460.010 Straight **\$10.95**

460.011 Bent Nose **\$10.95**

Foam Grip Box Joint Pliers

Top quality box joint construction, smooth, non-mar jaws. Brushed satin finish and double leaf spring return. Foam grip comfort handles. Overall length is 4 3/4".

461.080 Chain Nose **\$13.25**

461.081 Round Nose **\$14.00**

461.082 Flat Nose **\$14.00**

461.083 Bent Chain Nose **\$15.05**

461.084 Side Cutter **\$14.80**

461.085 Set of one each of above five pliers **\$68.25**

Precision Pliers & Cutters with Cushion Grips

Standard weight pliers and cutters feature box joints, return springs and cushion grip handles.



Pro-Line Box Joint Chain Nose Plier

Standard weight precision plier has box joint and plastic covered handles. Jaws taper to 1/32" at tips and jaw edges are beveled to prevent marring of soft wire. Serrated jaws. Length of Jaws 1 1/4", Overall Length 5 1/4". Made in Germany.

461.174 **\$40.25**

Chain Nose 5" Stainless Steel.

460.806 **\$11.95**

Bent Chain Nose 4 1/2" Stainless.

460.329 **\$11.95**

Round Nose 5" Stainless Steel.

460.808 **\$11.95**

Extra Long Needle Nose 5 1/2" Stainless.

460.810 **\$20.50**

Flat Nose 5" Stainless Steel.

460.809 **\$11.95**

Cutter Tapered Semi-Flush 4 1/2".

460.818 **\$18.00**

Tapered Cutter - Semi-flush, screw joint, return springs. 1/2" cut length, 4 3/4" long.

460.823 **\$40.25**

Side Cutter Semi-Flush 4 1/2" Carbon Steel.

460.819 **\$6.95**

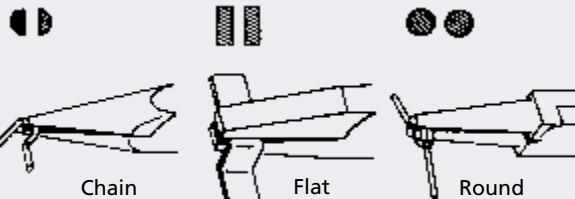

How to Select Pliers and Nippers

The overall lengths of the pliers and nippers in this catalog range from 4" to 8". Those over 5" are either for special work with long noses or are intended for heavier work.

Chain - Traditional and most popular pliers, used to make bends, loops and similar forming operations. Insides of jaws may be smooth or serrated.

Flat - For gripping and holding flat or square objects securely and for making angular bends. Insides of jaws may be smooth or serrated.

Round - For making bends, loops, circles, coils from wire or sheet metal. Tapered circular jaws are smooth so that they will not scratch or nick soft metals.

Nippers - For cutting a variety of wire. Edge shape determines how the ends of the cut wires will appear. Flush and semi-flush edges will not perform properly on hard wires.

Precision Slimline Box Joint Pliers and Nippers

Small pliers and cutters designed for detail work. All have box joints and cushion grip handles.

Chain Nose

Smooth jaws taper to 1/32" at tips and jaw edges are beveled to prevent marring of soft wire. For bending and manipulating wire. Length 4 3/4", length of jaws 7/8".

460.056 **\$20.95**

Flat Nose

Smooth jaws taper to 1/8" at tips. For holding and manipulating flat pieces. Overall length 5", length of jaws 7/8".

460.052 **\$19.95**

Round Nose

Smooth jaws. Used for making loops, bends, coils and similar operations. Overall length 4 1/2", length of jaws 7/8". Stainless.

460.815 **\$18.95**

Oblique Cutter

Head is angled with tip coming to a point for getting into tight places. Semi-flush cutting edges are for precision wire cutting of softer wires. 4 1/4" long, 9/16" cut length.

460.062 **\$31.95**

End Cutter

Semi-flush cutting edges are for precision cutting of softer wires. Jaws are set at right angles for getting close to work. Overall length 4 1/2", length of cut 9/16".

461.118 **\$44.50**

Flush Cut End Cutter

Flush cutting edges are for precision cutting of softer wire. Jaws are set at right angles for getting close to work. Overall length 4 3/4", length of cut 9/16".

461.058 **\$48.30**

Side Cutter

Semi-flush cutting edges are for precision wire cutting of softer wires. Overall length 4 1/4", length of cut 1/2".

460.066 **\$26.95**

Set of 5 Slimline Pliers

Contains three pliers; 460.052, 460.815 and 460.056, plus two nippers; 460.060 and 460.066, in vinyl pouch.

460.068 **\$107.95**

Set of Three Swiss Pliers on Wooden Base

These precision pliers will always be close at hand. Hardwood base keeps them in easy reach. Pliers feature box joints, cushion grip handles and double return springs. One each round, chain, and flat nose. All 4 3/4" long. Swiss made.

460.030 **\$44.95**



460.030



460.056

460.052

460.815

460.062

460.060

461.058

460.066

Swedish design, European made. World-renowned, used for years by jewelers and craftsmen



461.207 8140 460.209 8141 461.210 8150 461.211 8160



461.200 7190 461.201 7291 461.202 7490 461.203 7590 461.204 7890 461.205 7892 461.206 7893



460.222

460.223

460.224

460.225

460.226

LINDSTROM

80 Series Cutters (Yellow Handles)

The most advanced diagonal cutting nippers available, unsurpassed in cutting capacity. Manufactured with screw-type precision lap joint for optimum strength, exact movement and maximum accessibility. Dual spring-loaded handles and oval jaw.

Cas-Ker Number	Description	Lindstrom Number	Overall Length	Length of Jaws	Price
461.207	Micro-Bevel	8140	4.33"	0.39"	\$32.95
461.209	Flush Cut	8141	4.33"	0.39"	\$33.95
461.210	Micro-Bevel	8150	4.43"	0.49"	\$34.95
461.211	Micro-Bevel	8160	4.92"	0.63"	\$34.95

Supreme Series Pliers & Cutters (White Handles)

High quality, extremely precise and accurate pliers. Specially forged box joint with extra long contact surfaces. Joint moves smoothly for extra precision even at the tip. Box joint allows for smaller overall dimensions, improving accessibility in confined areas. Dual spring-loaded handles and comfortable cushion grips, marked with capacity information.

Cas-Ker Number	Description	Lindstrom Number	Overall Length	Length of Jaws	Price
461.200	Side Cutter	7190	4.29"	0.35"	\$34.95
461.201	End Cutter Flush	7291	4.25"	0.59"	\$76.40
461.202	Flat Nose	7490	4.72"	0.79"	\$29.95
461.203	Round Nose	7590	4.72"	0.79"	\$33.95
461.204	Long Chain Nose	7890	5.20"	1.26"	\$32.95
461.205	Curve Tip Chain	7892	5.08"	1.14"	\$34.95
461.206	Chain Nose	7893	4.72"	0.79"	\$32.95

LINDSTROM

The ultimate in precision, performance and comfort

The result of 150 years of making the world's leading pliers and cutters - *Lindstrom Rx*

Lindstrom Rx Series Pliers and Cutters

- Cushioned high friction handles are always comfortable and steady in your hand.
- Round shape makes it easy to rotate to the correct angle.
- Adjustable return spring provides different resistance and grip widths. Reduces fatigue over time in intensive use.
- Lightweight, easy to maneuver and position.
- Cutters have precision-ground edges for exceptional long life.
- Resin grip material safely dissipates electrostatic charges, reducing possibility of damage to sensitive components.
- Overall lengths 5.77" to 6.24". Swedish design made in Europe.



Cas-Ker Number	Lindstrom Number	Style	Jaw Length/Pliers Capacity/Cutters	Price
460.222*	Rx7490	Flat Nose Smooth Jaw	20.0	\$39.95
460.223*	Rx7590	Round Nose Very Fine	20.0	\$43.95
460.224	Rx7890	Chain Nose Smooth	32.0	\$56.00
460.225	Rx8141	Oval Flush Cutter	0.10-01.25	\$42.95
460.226	Rx8147	Tapered/Relieved Flush	0.10-01.0	\$70.95

Pliers for Jewelry & Watch Repair

Zig Zag Setting Plier

Invented by a stone setter, these pliers sit at just the right angle to bend prongs over without damaging stones. Made of high grade stainless steel with box joint, these little pliers can save you a lot of time and trouble. 4³/₄" long.



460.347

\$13.75

Nylon Jaw Tube Holding Plier

Nylon jaws have 10 holes for securely holding metal tubes without damage. Stainless steel with box joint and cushion grips. 6³/₄" long.

460.465 *

\$24.95

Straight Nylon Jaw Plier

Polished stainless steel with PVC grips and, best of all, nylon replaceable jaws. Box-joints for extra leverage. 5³/₄" long.

460.430

\$16.50

460.431 Replacement Jaws

\$5.25

Loop Closing Plier

Jaws are shaped and smoothly finished to close loops, jump rings, bracelet links, bows, etc., without distorting or scratching. Cushioned grips, 4¹/₂" long.

460.322

\$10.25

Brass Lined Flat Nose Plier

Jaws are brass lined and smooth to prevent marring of finishes and damage to delicate parts. Overall 4¹/₂", jaws 7/8".

460.316

\$18.95

Nylon Jaw Ring Bending Pliers

Ring Bending Pliers have replaceable nylon jaws and will not mar. Length 5". Box joint construction and cushion grips.

460.033

\$20.95

Nylon Jaw Deep Bending Pliers

Deep Bending Pliers have replaceable nylon jaws and will not mar. Length 5¹/₂". Box joint construction and cushion grips.

460.034

\$15.75

Wire Mandrels form perfect rings

For bead and wire artists who need to make consistent size wire loops. Stainless steel with non-slip PVC handles. Two sizes, each offering five different diameters: Small; 1.5, 2.5, 3.5, 4.5 and 5.0mm, and Large; 6.0, 7.0, 8.0, 9.0 and 10.0mm. Nicely rounded and extremely smooth so wire will not be scratched.

430.057 Small

\$9.95

430.058 Large

\$10.95

460.347

460.465

460.430

460.322

460.316

460.033

460.034

430.057

430.058



Pliers for Watch Repair

Spring Bar Bender

This plier has nylon jaws to make smooth curved spring bars out of straight ones. Box joint and cushioned handles.

460.103	\$16.50
460.103.1 Replacement Jaws	\$4.25

Clip Spring Plier

Specifically made to remove clip springs from Seiko style watch bands. The flat forked jaw rests atop the link, and the pointed tip fits under the clip spring. Squeeze the handle and the spring pops up for easy removal. 5" long overall.

460.135	\$18.95
----------------	----------------

Expansion Band Plier

Perfect for removing clip springs in expandable bands. Flat jaw rests atop the link, pointed tip fits under the clip spring. By squeezing, the clip spring pops up and can be easily removed for sizing. 5" long. Cushion handles and return spring.



460.136	\$11.95
----------------	----------------

Strap Notchers

Great for converting straps to fit Gucci, Swatch and other high fashion watches. Box joint. Spring loaded. Made in India

460.816	\$10.95
----------------	----------------

Case Closing Pliers

Parallel action with circular, rubber padded, hinged jaws. A steady gentle pressure snaps case shut. 7 1/2" Overall.

460.805	\$14.95
460.805.1 Replacement Jaws	\$3.25 pr

Bow Opening Plier

Jaws open when handles are compressed. For bows, links and rings. Spring keeps pliers closed. Special-joint, heavy-duty pliers. 5 3/4" long.

460.303	\$32.95
----------------	----------------

Pendant Bow Closing Plier

Heavy 6 1/2" plier for closing and adjusting pendant bows and bending rings. With box joint.

460.306	\$19.95
----------------	----------------

Bow Closing Plier

For small bows, loops, etc. Standard weight with one brass jaw to prevent marring. Box joint, stainless with cushion grips. 5 1/4" long. Made in Pakistan.

460.007	\$19.95
----------------	----------------



460.103

460.135

460.136

460.816

460.805

460.303

460.306

460.007

Wrap & Tap Ring Forming Plier

Wrap ring stock around the barrel shaped jaw, then tap it slightly on a mandrel and instantly make a complete ring, half or quarter shank for repair. The smaller jaw is covered with PVC tubing making these especially good for hollow rings and rings with a design on one side. Barrel measures 14mm for ladies rings. Makes perfect circles with stock up to 2mm thick. Stainless steel with cushion grips. 6" long.

460.375

\$23.25

Ring Bending Plier

For straightening and bending rings, wires, rods and strips. With smooth box joint. Overall length is 6¼", length of jaws 1¼", width 5/16". Cushion grips.

461.0062

\$20.35

Master Coiler Pliers won't mar wire

Make coils without nicking precious wire. Normal pliers nick, but the Master Coiler lets you hold the wire with the flat jaw while rotating the round jaw to form the perfect loupe. Comfort grips, stainless steel jaws, standard step-jaw for consistent coils.

460.521

\$13.25

Looping Plier

For looping wire or flat strips of metal. One jaw is round and the other is flat. The 5¼" pliers have cushion grips and box joint construction.

460.370

\$8.95

Wire Looping Plier

Stepped nose design with one round and one concave jaw, permits smooth looping. Overall length is 4½".

461.039A

\$21.05

Tapered Flat Nose Pliers

Narrowed fine tips allow greater control when bending wire. Box joint construction with return springs.

460.031 1.0mm Width

\$8.75

460.027 1.5mm Width

\$8.75

460.028 2.0mm Width

\$8.75

Bent Nose Chain Plier

Tips are angled 60° for picking up and manipulating precision wires. Lightweight, overall 5", jaws 1" long. Return spring and plastic grips. Smooth jaws.

461.328

\$37.10

Pliers for Jewelry & Watch Repair

460.375



461.0062



460.521



460.370



461.039A



460.031

460.027

460.028



461.328

Find more wire bending tools on page 305.

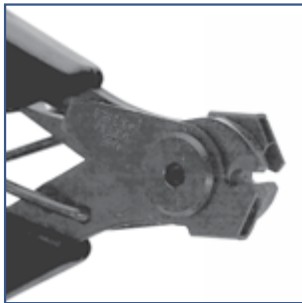

460.339



Flat Wire Cutter

The Xuron hard wire cutter has a self-adjusting clamping fixture which holds the wire perpendicular to the jaws. Simplifies the cutting process while allowing for flat cuts on both the cut and cut-off sides of the wire. Cuts memory wire, silver, gold and copper wire up to 14 gauge. Length 5-1/4 inches (135mm). Made in USA.

460.339

\$35.95

Looping Pliers

Make a perfect measured loop every time with Acculoop Precision Round Nose Pliers! Jaws clearly marked with measurements for making loops that range from 2 to 8mm. Length 6-1/2".

460.349

\$18.95



460.349

Wubbers Pliers

Ergonomic grip and suede-like coating.

460.041 Chain Nose **\$23.95**

460.042 Round Nose **\$23.95**

460.043 Flat Nose **\$23.95**

460.044 Bent Nose **\$23.95**

460.045 Nylon Double Flat **\$23.95**

460.046 Nylon Flat/Metal Round **\$23.95**

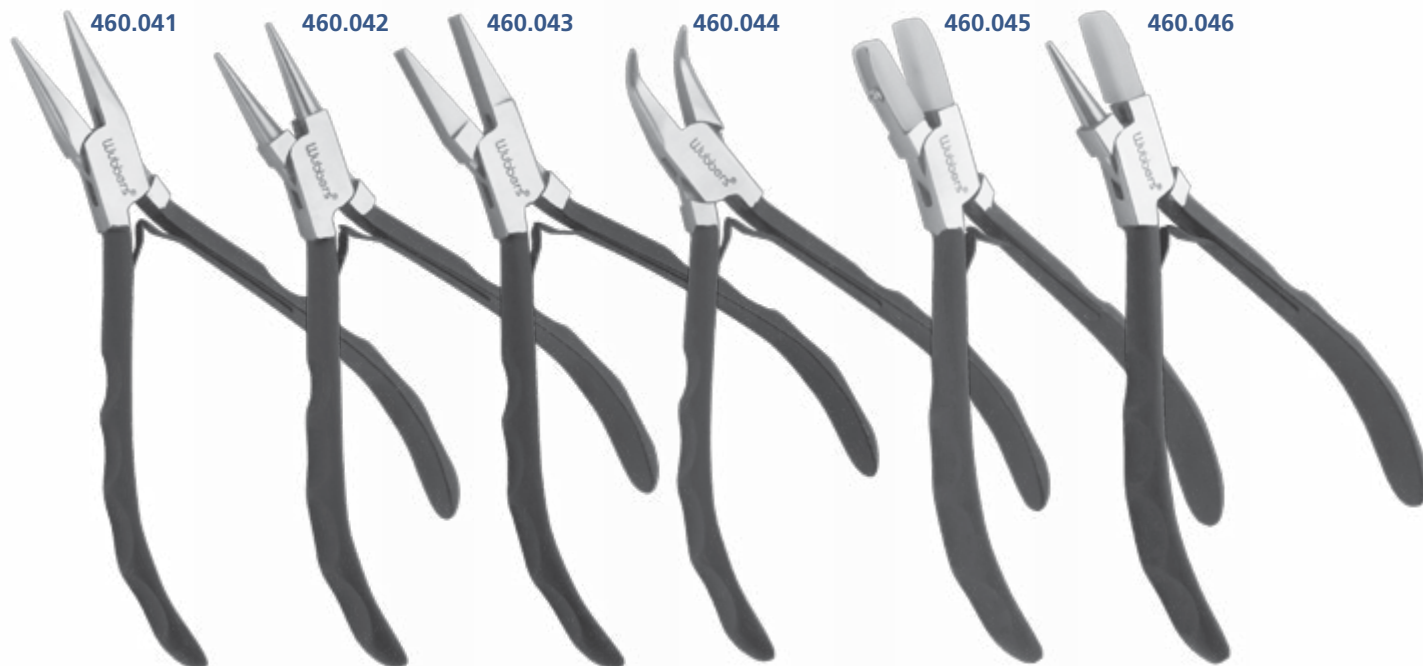

460.041

460.042

460.043

460.044

460.045

460.046

Glitter Line Pliers & Cutters

This line of mini pliers features very precise tips for wire wrappers and bead stringers in particular. Glitter line pliers have teal glitter comfort grips, rugged box joint construction and double-leaf springs. All are 4½" long.

460.094	Chain Nose	\$7.25
460.098	Bent Chain Nose	\$7.65
460.096	Round Nose	\$7.25
460.095	Flat Nose	\$7.25
460.097	Side Cutter	\$7.65



460.522

**Glitter Pliers -
The perfect choice
for beaders**

460.094

460.098

460.096

460.095

460.097



BEADSmith Economical Plier Set

This all purpose set includes Round and Chain Nose Pliers and a Side Cutter with color coded cushion grips. Lapjoint construction, polished steel heads and double leaf springs.

460.522	\$12.25
---------	---------

BeadSmith Minis - Portable tools for beaders on the go

Set features seven miniature tools: Chain Nose Pliers, Round Nose Pliers, Flat Nose Pliers, Side Cutter, Nylon Jaw Pliers, #5 Knotting Tweezers and Split Ring Tweezers. Pliers feature polished steel heads, PVC handles, lapjoint construction, single-leaf springs, and are 3" - 3.5" long.

460.111	\$27.50
---------	---------



460.111

Four-in-One Bead Crimping Plier & Chain Nose Plier

From Xuron® - a bead crimping plier that precisely crimps/folds 1, 2, and 3 millimeter crimp tubes and includes a chain nose plier for handling delicate beads, micro-crimps and for adding an extra squeeze to your crimps, if desired. The folding stations are designed to fit three different size crimp tubes (1, 2 & 3 mm) and ensure a secure and attractive result. As with all Xuron® Pliers, the 4-in-1 Crimper has soft rubber hand grips and a return spring that opens the tool after each squeeze. Made in USA.

460.363	\$20.95
---------	---------

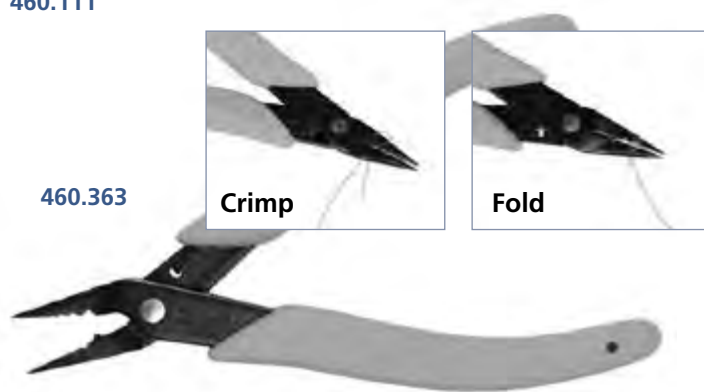

460.363

Crimp

Fold

Jewelers' Series Box Joint Pliers and Cutters

This series is standard weight and size for medium to small work. These are precision pliers and nippers with box joints to eliminate side play and maintain alignment of jaws even under stress. Heads are brightly polished and the handles have vinyl cushion grips.



461.110



461.106



461.104



461.102

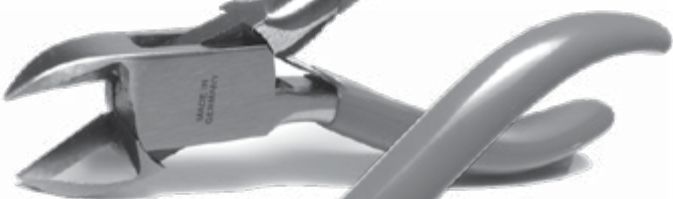

461.124
460.803



461.120

Long Chain Nose Plier

Jaws taper to 1/32" at tips. Used to make bends and for gripping and manipulating wires. Overall 6", length of smooth jaws 1 1/2".

461.110 **\$35.75**

Chain Nose Plier

Smooth jaws taper to 1/32" at tips and jaw edges are beveled to prevent marring of soft wire. Used to make bends and for gripping wires. Length 5 1/4", jaws 1".

461.106 **\$22.50**

Round Nose Plier

Smooth jaws taper to 1/32" at tips. Used for making loops, bends, coils and similar operations. Length overall 5 1/4"; jaws 1".

461.104 **\$34.65**

Flat Nose Plier

Smooth jaws taper to 3/16" at tip. For holding and manipulating flat pieces. Overall length 5 1/4", length of jaws 1".

461.102 **\$21.95**

Side Cutter

Semi-flush cutter for heavy cutting of soft to medium hard wires. Box-joint. Overall length 5".

461.124 5/8" Cut, Made in Germany **\$29.95**

460.803 11/16" Cut, Made in Pakistan **\$19.25**

End Cutter

Regular edges for cutting soft to medium hard wires. Jaws set at right angles for getting close to work. 5 1/4" long, cut length 3/4".

461.120 **\$48.25**

Set of 5 Jewelers' Series Box Joint Pliers

Contains three pliers, Nos. 461.102, 461.104 and 461.106, plus two cutters, Nos. 460.120 and 461.124, in a deluxe vinyl pouch.

461.132 **\$139.00**

BERGEON 6283

Set of 6 Pliers & Cutters

Set includes six polished steel pliers with box joints and cushion grips on wooden storage base. Includes Bergeon items:

- 2624 Flat Nose Serrated
- 2625 Round Nose Serrated
- 2626 Chain Nose Serrated
- 2627 Straight End Cutter
- 2628 Oblique End Cutter
- 2629 Side Cutter

460.577 **\$282.50**



460.577

OVERNIGHT DELIVERY

Mon-Thur Call by 3:00PM Your Local Time

Friday Call by 3:00PM Eastern

Prong Opener

These prong opening pliers will not fracture stones. Puts no pressure on the top of the stone. A claw grips the prong cleanly and the lower jaw is grooved to hold prong. Germany.

460.133 **\$26.50**

Stone Removal Plier

Easily removes stones from settings while preventing damage. Use on all prong settings, bead settings, clusters, channels, fishtails and baguettes. Thin, narrow tips fit into tight recessed areas and very small settings. Box joint for perfect alignment of jaws and cushion grip handles for comfort.

461.0059 **\$23.15**

Prong Opening Plier

A plier for opening prongs that will not fracture stones. A claw grips the prong cleanly, and the lower jaw is grooved to hold prong. Puts no pressure on the top of the stone.

460.600 **\$39.95**

Damascus Setting Plier

German made precision pliers for tightening or setting stones. Small jaw is notched for prongs. Box joint, cushion grips.

461.348 **\$57.60**

Stone Setting Plier

For setting or tightening the prongs on stone set rings. Jaws are shaped so that they fit over the prongs on a setting. 5" long.

461.346 **\$18.40**

Beading Tool Pliers

These pliers provide the "foundation" behind the pressure that a beading tool applies. You will no longer have to use shellac to fill the interior of the item or mount it on a shellac stick like you do when using a beading tool. These two models of Beading Tool Pliers are useful in dozens of other ways; setting, tightening or even general goldsmithing. Both pliers 4 1/2" long with cushion grips and return springs.



460.019 #20 Tip



460.018 #14 Tip

- Setting Pliers have the equivalent of a #20 beading tool tip. Use like beading tools only much easier in many cases. Use to hold stones (cutlet to table) while being heat set into wax models. Beading cup can be made smaller by sanding down the inside of the jaw, or larger by using a ball bur. To meet the cup closer, trim the outside down. Cushion grips and return springs.

460.019 Setting/Beading Pliers #20 Tip **\$14.25**

- #1 Conner Bead Setting Pliers. Replaces the common beading tool on a great many jobs, making them easier. No longer will you need to hold items in a ring clamp or use shellac. Gives support from underside for common, everyday tightening and setting in stones. Used like a beading tool 50% of the time. Can be used to hold stones while being heat set into wax models.

460.018 Conner Setting/Beading Pliers #14 Tip **\$14.25**

Specialty Pliers for Stone Setting

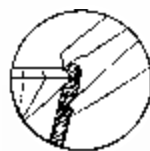

460.133



461.0059



460.600



461.348



461.346



460.019

460.018

Find more STONE SETTING TOOLS on page 209.

Cas-Ker Specialty Cutters



460.573

Flush-Cutting Knot Cutter

Ideal for cutting thread, cotton cord, leather thong and soft wire. Shearing action minimizes cutting effort. Flush cut requires less finishing. Spring-action and cushioned grips, 5" long. Not suitable for cutting memory, flex or steel wire.

460.573

\$6.25

460.012

Semi-Flush Side Cutter

The perfect answer to crafts people who need strength in a precision side cutter. Smooth spring return and ergonomic cushion grip handles. Maximum cut 2mm copper wire. Italy.

460.012

\$28.75

461.0222

Slim-Line Midget Nipper

For flush cutting wire less than .025". Nickel-plated with box joint and on-off leaf spring. Will snap cut along cutting edge as well as at tips. Overall 4", width of jaws 7/32".

461.0222

\$29.95

460.828

Carbide Jaw Cutter for hard wire

Small cutter made particularly for hard wire. Features carbide jaw inserts for maximum hardness, PVC grip handles and gentle return springs. Almost indestructible when used properly, giving you years of service. 4½" long.

460.828

\$24.25

460.005

Carbide Tip Side Cutters

These durable Side Cutters feature carbide tips for precision and ease of cutting. Box joint construction, cushion grips and return springs. 1/2" cut, 5" overall. Swiss made by Precitec.

460.005

\$41.95

460.003

Carbide Tip Tapered Side Cutters

These durable Side Cutters feature carbide tips for precision and ease of cutting. Lap joint with screw, cushion grips and return springs. 7/16" cut, 4¾" overall. Swiss made by Precitec.

460.003

\$46.00

460.462

Right Angle Ring Shank Shear Cutter

For ring shanks 2.5mm or less. One jaw is flat, the other curved to conform to most rings. Provides a clean, right angle cut so both sides can be easily rejoined. Sweeping up gold or silver filings won't be necessary. Cutter does not easily dull or break.

460.462

\$21.75

460.004

Carbide Tip End Cutter

These quality built End Cutters feature carbide tips for precision and ease of cutting. Box joint construction, cushion grips, return springs. 1³/16" cut, 5" long. Made in Switzerland.

460.004

\$44.95

460.826

Full Flush Cutter

Specifically developed in Germany for multi-strand beading wire. Full flush induction hardened jaws (60-62 Rockwell) assure a clean cut, time after time. Edges are precisely aligned. Black non-glare head has relieved design for tight areas. Double-leaf springs and PVC handles. Use on flexible wire and soft wire only. 4½".

460.826

\$29.75

Bracelet and Wire Cutters

Double-jointed Carbide Cutter

Oblique cutter with carbide insert is suitable for cutting up to 14 gauge stainless steel or other hard metals. Double jointed for extra strength and leverage. The special non-slip grip and leaf spring ensures comfort with every use. Length 6".

460.829 **\$43.95**



460.829

Compound Cutter

Cuts metal hard wire and sprues quickly and cleanly. Compound leverage multiplies the pressure exerted. Lock keeps pliers closed when not in use to protect cutting edges. 5/8" jaws. 8 1/4" long. Maximum jaw opening 1/4". Cuts up to 1mm hard wire.

460.464 **\$15.50**



460.464

Band End Cutter

Ideal for shortening steel watch bands and other heavy cutting jobs. Hardened carbon steel with cutting edge adjustment. Short jaws for higher leverage and cutting power. Slide locks jaws in closed position. Pressed steel handles. 11/16" wide jaws. 8" long.

460.578 **\$54.95**



460.578

Parallel Action Pliers and Cutters

Jaws open and close parallel along entire length, providing a square vise-like grip. Handles and jaws are nickel-plated.

Heavy Flat Nose Plier has serrated jaws with "V" slot running length of jaws for holding wire. Overall length is 5 1/2".

461.506 **\$32.40**

Light Flat Nose Plier with serrated or smooth jaws. 5" long.

461.510 Serrated jaws with "V" slot **\$29.75**

461.512 Smooth jaws (not shown) **\$34.45**

Combination Plier flat nose with serrated jaws and "V" slot, with a wire cutter.

461.514* Overall length 5" **\$44.10**

461.516* Overall length 5 1/2" **\$46.85**

Chain Nose Plier has smooth jaws. Overall 5".

461.520 **\$42.95**

Diagonal Cutter has spring action handle. 5 1/2" long with maximum jaw opening of 1/4".

461.532 **\$43.10**



461.532



461.506

461.510
461.512

461.514
461.516

461.520

More
BEADING
TOOLS & SUPPLIES
on pages 193-198.



460.523

Specialty Pliers & Cutters for Beading

Beadsmith 1-Step BIG Looper

Create and trim loops in one easy step! Make your own custom-length head and eye pins. Works with soft or half-hard precious metal wire, craft wire and copper or brass core wire. Makes a consistent size 3mm loop every time. Bends and trims wire between 24 and 18 gauge.

460.523 \$31.50

Bead Knotting Plier

Stainless steel with cushion grips, our needle nose box-jointed plier will allow you ease and comfort while beading. Knotted cord slides off this finely tapered nose, forming knots close to beads with minimum effort. A must for all bead makers.

460.580 \$9.95

Tapered Flat Nose Pliers are ideal for wire bending

The fine tips of these flat nose pliers have been narrowed to allow greater control when bending wire. Box joint construction.

460.031 1.0mm Width \$8.75

460.027 1.5mm Width \$8.75

460.028 2.0mm Width \$8.75

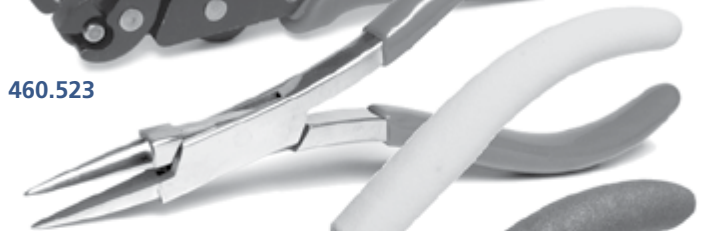

460.580



460.031

460.027

460.028

Magical Crimp Forming Plier transforms crimps into round beads

This unique, patented tool was created exclusively for use with 2mm sterling silver and gold filled tubular crimp beads. Just a few easy steps will form a 2mm crimp into a more appealing round bead! Designed exclusively for use with .014-.015" or .019" diameter Flex Wire.

460.113 for .014-.015" Flex Wire \$18.75

460.109 for .019" Flex Wire \$18.75



460.113

460.109

Split Ring Opener

Opens split rings easily. Just put the tooth jaw between the overlapping split ring and squeeze. The split ring pops open, ready for the user to put on chains, etc.

460.589 \$8.75



460.589



530.020

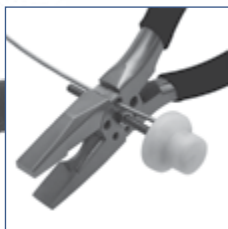

Accu-Shear

Midland Accu-Shear from EuroTool, for cutting heavy wire. Double flush cut shear.

530.020 \$44.95

3 EASY WAYS TO ORDER:

- CALL 1-800-487-0408. Order by SKU number
- FAX 1-800-487-5848. Fax order form at back of this catalog
- ONLINE at www.casker.com

Beading Nipper

Economical cord cutter is indispensable for anyone involved with bead stringing. It's shaped perfectly to cut close in all beading situations. Easily cuts regular bead cord and tigertails. Return spring and cushion grips.

460.571 **\$6.50**

Cutter for Soft Flex-Wire

Finally a plier suitable to cut multi-strand flex-wire time and time again. This cutter is made of high carbon steel blades that are precision ground to ultra sharp cutting edges. Made in USA.

380.042 **\$9.50**

Double Flush Memory Wire Cutter

Self-adjusting clamping fixtures hold the material perpendicular to the cutter jaws. Simplifies cutting, adding to the precision of the cut and cutting capacity. Square ended cuts on both the cut and off-cut sides. Cuts hard wire up to 0.060". 5/4" l.

460.134 **\$27.50**

Micro Crimper Plier

Created specifically for the new smaller crimps that are popular today. Works on crimps as small as 1.5mm and up to 3mm with surprising effectiveness, forming a smooth unobtrusive crimp. You'll need both the Micro Crimper and a standard crimping plier at your worktable. 5" long.

460.586 **\$11.50**

Bead Crimper

Forms a smooth, unobtrusive crimp. Banishes forever the unsightly sharp-edged crimp formed by conventional methods. Finished crimp can be hidden in a clam-type bead tip or slipped into a large-hole bead. Works with either round or tube crimps. With a few practice crimps and instructions.

460.585 **\$16.50**

Eurocrimper™ lets you crimp any bead quickly, easily

The Eurocrimper has two forming cavities for round, tube and combination crimps of slightly varying sizes. True ergonomic handles give you a great grip because they are made from sanoprene - a special compound with excellent surface tack. Jaws are precision machined for years of service and beautiful results every time. Crimp any crimp bead of medium size (2mm - 3mm) and various shapes.

460.116 **\$14.25**

Beading Snips

Small versatile shears have sharp points. Especially useful when stringing pearls. Easily cut cord and snip apart knotted strands before restringing. Length 4 1/8".

530.000 with Stop Guide **\$3.25**

531.01400 without Stop Guide **\$5.50**



Bead Crimps on page 196.



131.377



131.379

White Plastic Pliers Rack

Edges are specially designed for safety. Keeps pliers organized, protected and easy to identify. 5" x 5 1/2" x 9".

131.377* **\$38.85**

Durable Clear Acrylic Tool Holder

Designed to keep all of your tools organized, and protected. Five vertical pockets, a twelve hole shelf, and an angled pliers rack. Stand on bench or hang from wall. 12" x 5" x 7 3/4".

131.379 **\$79.95**



130.378



130.399

8" Clear Acrylic Bench Rack

This rack is a simple design but one of the most functional for holding your favorite pliers and cutters. 8"W x 4"H x 4 1/2"D.

130.378 **\$14.25**

Wooden Plier Stand

Attractive, functional stand keeps six pair of pliers in easy reach. 6 1/4" x 3" x 1".

130.399 **\$7.75**



130.389



380.343

Acrylic Plier Rack

This handy rack sits securely on your bench to hold the pliers you use most. Clear acrylic stand measures 5 1/2"W x 4 3/4"H x 4"D.

130.389 **\$14.25**

Durable Blue Canvas Tool Case

Notebook style case holds up to 16 hand tools tweezers, pliers, watchmaker's tools and more. Zips completely around. 10 3/4" x 6 1/2" x 1 1/2" closed. Soft flocked lining protects tools and elastic bands hold them firmly in place.

380.343 **\$16.50**



131.380 - 131.382

Magnetic Tool Holders

Permanent magnets hold pliers, screwdrivers and miscellaneous tools in place. Mount on any surface that will accept screws.

131.380 12" long **\$43.95**

131.381 18" long **\$51.40**

131.382* 24" long **\$59.95**

PLIERS on pages 155 - 170.

More tool ORGANIZERS on pages 144, 181, & 312.

Pro Shears

Comfort grip cutting shears cuts up to 20 gauge soft metal.

530.200 **\$12.95**

Straight Shears

Longer handles and short blade for greater leverage. Will cut copper up to B & S #20. 7¹/₄" long with a 1¹/₂" length of cut. Germany.

530.820 **\$23.25**

Quality Shears

Made of finest steel for years of cutting. Made in USA. 7³/₄" long.

530.801 **\$23.75**

Lightweight Snips

For cutting templates and patterns from medium hard metal sheet up to B & S #20 or soft sheet to B & S #16. Available with straight or curved blades (for cutting circular shapes). Overall length 7" with a 1¹/₂" length of cut. Made in Germany.

531.800 Straight Blade **\$15.95**

531.802* Curved Blade **\$27.30**

Lightweight Metal Snips

For cutting templates and patterns from medium hard metal sheet up to B & S #20 or soft sheet to B & S #16. Plain handles. Overall length is 7" with a 1¹/₂" length of cut. Made in Germany.

531.804 Straight Blade **\$17.75**

531.806* Straight w/Spring Return **\$46.80**

531.808* Curved Blade **\$27.65**

Compound Action Shears

Suited for straight or shallow arc cutting. Cuts copper up to B & S #16 with half the effort of ordinary shears. Serrated blades prevent slippage. Overall length is 10" with a 1¹/₂" length of cut. U.S.A.

531.836 **\$42.00**

Jewelers' Shears with Leaf Springs

Long handle permits greater flexibility in cutting. Excellent for clipping chains, solder and thin metal. Jaws are polished and the handles blackened. Straight blade. Overall length is 7".

531.0917 **\$16.35**

Crown Scissors

Made of drop forged steel, expertly tempered and hardened. Edges are hand ground to retain a keen cut after long use. For hard wire or sheet up to B & S #27 and soft wire up to B & S #16. Straight, short, stubby blades 9/16" long and 1/4" wide. Overall 4¹/₈" with large loop handles. Made in Germany.

531.620 **\$27.75**

Short Blade Scissors

Stainless steel, near razor-sharp blades cut fine wire, filament threads, nickel ribbon, etc. Widely used in electronics and precision applications. Overall length is 3¹/₂" and length of cut is 1/2".

531.201 Straight Blades **\$13.95**

531.205* Curved Blades **\$13.95**





520.765

A Precision Screwdriver Set for Every Application and Budget

High Precision Swiss Screwdrivers with Concave Tips

The concave parallel blade tips fit a screw slot more precisely than standard blades, allowing you to apply more torque without damaging a screw. Set of 12 sizes with ball-bearing, color-coded heads on rotating stand. Spare blades included.

520.765 **\$386.00**

Replacement Blades

Number	MM	Each	6@	Number	MM	Each	6@
520.766.60	0.60	\$7.50	\$7.25	520.766.140	1.40	\$7.50	\$7.25
520.766.70	0.70	\$7.50	\$7.25	520.766.160	1.60	\$7.50	\$7.25
520.766.80	0.80	\$7.50	\$7.25	520.766.180	1.80	\$7.50	\$7.25
520.766.90	0.90	\$7.50	\$7.25	520.766.200	2.00	\$7.50	\$7.25
520.766.100	1.00	\$7.50	\$7.25	520.766.250	2.50	\$12.50	\$11.25
520.766.120	1.20	\$7.50	\$7.25	520.766.300	3.00	\$12.50	\$11.25



520.700

Set of twelve high precision VOH Swiss screwdrivers on a color-coded base for quick and easy selection

Twelve sizes with color-coded swivel heads on heavy-weighted rotating stand. Blade diameters: .60, .70, .80, .90, 1.00, 1.20, 1.40, 1.60, 1.80, 2.00, 2.50, 3.00mm. Includes 50 spare blades (4 ea. of the smaller, 2 ea. of the larger sizes) stored under a clear lid in the center of the stand.

520.700 **\$399.00**



520.015

Horia Eight-Piece Screwdriver Set

Quality Swiss made with color identifying bands. Blades are firmly held by set screw. Sizes .60 .80 1.00 1.20 1.40 1.60 2.00 and 2.50mm. Swivel ball bearing heads and knurled handles. Space-saving stable stand is angled forward for ease of selection.

520.015 **\$136.95**

Set of Nine Screwdrivers on Rotating Stand

This set of 9 premium, color-coded set-screw screwdrivers includes 19 spare blades and two extra set-screws. The rotating stand gives easy access for busy repairmen. Made in France.

520.541 **\$52.95**



520.500



520.541



520.605

Economy Set of Nine Screwdrivers on Stand

Chromed steel screwdrivers have color identifying bands. Blades held by set screw, cannot turn or twist. Sizes .50 .60 .80 1.00 1.20 1.40 1.60 2.00 and 2.50 mm. Swivel heads and knurled handles. Stable stand includes one spare blade each size in center compartment. India.

520.500 **\$11.95**

Set of Nine Anti-Magnetic Screwdrivers on Rotating Stand

Beryllium blades, with extra blades included in center compartment. Sizes .60, .80, 1.00, 1.20, 1.40, 1.60, 2.00, 2.50, 3.00.

520.605 **\$65.95**

Genuine **BERGEON** Screwdrivers

Bergeon 30081-S Set of Nine Screwdrivers

Bergeon set of nine ergonomic screwdrivers on a rotating stand. Screwdrivers feature stainless steel shanks and handles, and color-coded, self-lubricating, synthetic swivel heads. Hardened stainless steel blades in diameters 0.50, 0.60, 0.80, 1.00, 1.20, 1.40, 1.60, 2.00 and 2.50mm. Includes 9 spare blades. Swiss made.

640.30081 **\$112.95**



640.30081

Bergeon 8899 Set of Nine Anti-magnetic Screwdrivers

The latest ergonomic screwdrivers feature an elastomer membrane on aluminum shanks and synthetic heads for the ultimate in comfort. Superalloy blades provide excellent mechanical strength. Diameters 0.5, 0.6, 0.8, 1.0, 1.2, 1.4, 1.6, 2.0 and 2.5mm. Rotating base has slots with spare blades.

640.8899 **\$179.95**



640.8899

Bergeon 6899 Ergonomic Screwdrivers offer you more comfort and better control

This genuine Bergeon Screwdriver Set features 10 different color coded sizes: 50, 60, 80, 100, 120, 140, 160, 200, 250 and 300, each with two spare blades. Stainless steel blades. Rubber knurled grips and swivel heads provide precision control. Heavy weighted rotating stand stays put on your bench, always close at hand. Swiss made.

640.6899 **\$289.95**



640.6899

Bergeon Screwdrivers are Color Coded for Quick Selection.

Bergeon 3044-A Set of Ten Screwdrivers on Rotating Stand

First quality chromed screwdrivers on a very stable non-slip base. Set of 10 contains sizes .50, .60, .80, 1.00, 1.20, 1.40, 1.60, 2.00, 2.50 and 3.00 mm. Spare blades in plastic tubes.

641.3044A **\$279.25**

641.3044* Replacement Stand (special order) **\$129.15**



641.3044A

Bergeon Magic Wiper® Magnetic Sheet

Recover small metal parts easily! Paper component collector is tearproof and washable. Easy to use and clean. Consists of ONE double-sided magnet strips. Supplied flat. Folded dimension: 285 x 82mm.

640.7871 **\$23.95**

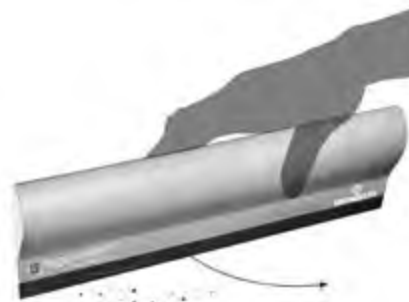

640.7871

BERGEON

Genuine **BERGEON** Screwdrivers



520.576

BERGEON Set of Ten Screwdrivers in Wooden Box
 Bergeon Sizes .50 .60 .80 1.00 1.20 1.40 1.60 2.00 2.50 and 3.00mm in black wooden case. Spare blades in plastic tubes.
 Bergeon 30080-A10.

520.576 **\$152.95**

BERGEON 2868 Set of Five Screwdrivers
 Quality chromed in sizes .50, .60, .80, 1.00 and 1.20 mm. One spare blade each size.

520.286 **\$68.95**

BERGEON 4063-A Set of Three Screwdrivers
 First quality chromed tool steel screwdrivers, 0.80, 1.00 and 1.20mm wide with one spare blade each.

520.008 **\$47.95**



520.286

520.008



BERGEON 5971 Individual Drum Barrel Screwdrivers
 High torque adjustable knurled grip. Ball bearing hex head ideal for watches submitted to shocks & vibrations.

640.5971.100	1.00mm	\$16.95
640.5971.120	1.20mm	\$16.95
640.5971.140	1.40mm	\$16.95
640.5971.160	1.60mm	\$16.95
640.5971.180	1.80mm	\$16.95



BERGEON Individual Screwdrivers & Blades

For sets 640.2639, 640.2631, 640.3044A, 520.540.

Diam.	Screwdrivers	Each	Blades	Each	10 @
0.50	640.30080/B	\$16.75	640.30080A/50	\$1.35	\$1.25
0.60	640.30080/C	\$16.75	640.30080A/60	\$1.35	\$1.25
0.80	640.30080/D	\$16.75	640.30080A/80	\$1.35	\$1.25
1.00	640.30080/E	\$16.75	640.30080A/1.00	\$1.35	\$1.25
1.20	640.30080/F	\$16.75	640.30080A/1.20	\$1.35	\$1.25
1.40	640.30080/G	\$16.75	640.30080A/1.40	\$1.35	\$1.25
1.60	640.30080/H	\$16.75	640.30080A/1.60	\$1.35	\$1.25
2.00	640.30080/J	\$16.75	640.30080A/2.00	\$1.95	\$1.75
2.50	640.30080/K	\$16.75	640.30080A/2.50	\$1.95	\$1.75
3.00	640.30080/L	\$16.75	640.30080A/3.00	\$1.95	\$1.75

BERGEON Individual Ergonomic Screwdrivers & Blades

Ten different color coded sizes. Rubber knurled grips and swivel heads provide precision control. Stainless steel blades.

Swiss made. Bergeon Screwdrivers 6899-050 thru 6899-300.

Screwdrivers	Diam.	Each	Blades	Diam.	Each
640.6899.50	0.50	\$15.25	640.6899M.50	0.50	\$1.50
640.6899.60	0.60	\$15.25	640.6899M.60	0.60	\$1.50
640.6899.80	0.80	\$15.25	640.6899M.80	0.80	\$1.50
640.6899.100	1.00	\$15.25	640.6899M.100	1.00	\$1.50
640.6899.120	1.20	\$15.25	640.6899M.120	1.20	\$1.50
640.6899.140	1.40	\$15.25	640.6899M.140	1.40	\$1.50
640.6899.160	1.60	\$15.25	640.6899M.160	1.60	\$1.50
640.6899.200	2.00	\$15.25	640.6899M.200	2.00	\$1.50
640.6899.250	2.50	\$15.25	640.6899M.250	2.50	\$1.50
640.6899.300	3.00	\$15.25	640.6899M.300	3.00	\$1.50

BERGEON Set Screws for Screwdrivers

Set Screws	For Sizes	Pack of 10
640.30080X	0.50	\$4.95
640.30080Y	0.60 - 1.60	\$4.25
640.30080Z	1.80 - 3.00	\$4.25

HOROTEC Precision Set of 12

Finest quality Swiss made screwdrivers on a heavy rotating stand. Colored ball bearing swivel heads for smooth, precise operation. Replaceable blades held with set-screws. Full range of sizes 50 thru 300 with extra blades stored in base (not color coded).

520.542 **\$359.95**

Horotec Replacement Blades below

Horotec Precision Set of Twelve Screwdrivers with Color Coded Base

Set of twelve Horotec steel screwdrivers on heavy weighted rotating stand. Color coded ball bearing heads for easy selection. Sizes: .50, .60, .70, .80, 1.00, 1.20, 1.40, 1.50, 1.60, 2.00, 2.50, and 3.00mm. Includes spare blades which store in the center of the stand. Finest Swiss made quality.

520.544 **\$409.95**

HOROTEC Set of Six Screwdrivers

Quality Swiss made with color identifying bands. Blades are firmly held by set screw. Sizes .60 .80 1.00 1.20 1.40 and 2.00mm. Swivel ball bearing heads and knurled handles. Stable stand is angled forward for ease of use. One spare blade each size.

520.005 **\$144.95**



520.543

HOROTEC Screwdrivers with Ball Bearing Heads

Ideal screwdrivers for the watchmaker. The ball bearings in the color coded swivel heads offer the smoothest operation for greater control. Blades are held with set screws. 3 1/2" long with knurled handles. Swiss made.

520.543/.50 0.50 mm **\$18.95**

520.543/.60 0.60 mm **\$18.95**

520.543/.90 0.90 mm **\$18.95**

520.543/1.00 1.00 mm **\$18.95**

520.543/1.20 1.20 mm **\$18.95**

Horotec Replacement Blades

Number	MM	Number	MM	Number	MM
520.542.50	0.50	520.542.110	1.10	520.542.160	1.60
520.542.60	0.60	520.542.120	1.20	520.542.180	1.80
520.542.70	0.70	520.542.130	1.30	520.542.200	2.00
520.542.80	0.80	520.542.140	1.40	520.542.250	2.50
520.542.90	0.90	520.542.150	1.50	520.542.300	3.00
520.542.100	1.00				

Horotec Replacement Blades **\$1.75 each**

Horotec Screwdrivers with hollow-ground concave tips

Assortment of ten screwdrivers with smooth operating, color-coded ball bearing heads, concave tips, fine knurled handles and extra blades. The hollow-ground screwdrivers have a concave curve on each side of the sharp, flat tip. This tip provides smooth, even power transfer with complete metal-to-metal contact between the tip of the bit and the entire screw slot, making slipping and damaging a screw head much less likely. Swiss made.

520.525 **\$256.95**



520.542



520.544



520.005



520.525



520.003

Beryllium Screwdrivers won't mar screws

These anti-magnetic screwdrivers have soft tips to prevent scratching hard watch screws. Especially good for use on blue steel screws. Set of six includes sizes; 0.60, 0.80, 1.00, 1.20, 2.00, 3.00mm. Made in France.

520.003 **\$54.95**

Replacement Blades, price each

520.004.60	0.60mm	\$1.60	520.004.120	1.20mm	\$1.60
520.004.80	0.80mm	\$1.60	520.004.200	2.00mm	\$1.60
520.004.100	1.00mm	\$1.60	520.004.300	3.00mm	\$1.60

Set of Three Fixed Blade Screwdrivers

Set of three with fixed blades. Non-roll swivel heads are color coded. Sizes 1.00, 1.20 and 1.60mm. Made in France.

520.002 **\$6.95**

Economy Set of Seven Screwdrivers

Swiss style color coded screwdrivers have set screw replaceable blades. Non-roll swivel heads. One each replacement blades, all in folding pouch. India.

520.299 **\$4.25**

Set of Five Phillips Screwdrivers

Five screwdrivers have color identifying swivel heads. India.

520.410 **\$3.25**

Set of Five Swiss Horotec Phillips Screwdrivers

Knurled nickel-plated brass handle provides a sure grip. Color-coded, hexagonal head makes size identification easy and prevents rolling. Strong, heat treated steel Phillips blades. In protective pouch. Sizes below.

521.0720 **\$33.95**

Individual Grobet Phillips Screwdrivers

Screwdriver	Blade Diameter (in)	Diameter (mm)	Color	Price
521.571	.047"	1.20	Gray	\$7.40
521.572	.060"	1.50	Violet	\$7.40
521.573	.078"	2.00	Green	\$7.40
521.0724*	.089"	2.50	Blue	\$7.70
521.0725*	.118"	3.00	Brown	\$7.70



520.001

Screwdriver Set with Reversible Blades

Perfect for watchmakers, optical, hobby, camera and home use. Reversible blades provide four straight and four phillips tips. Aluminum knurled handle with non-roll swivel head. Blades snap in and out easily for quick changes. Straight sizes 1.6, 2.0, 2.4 and 3.2mm. Phillips sizes 000, 00, 0 and 1.

520.001 **\$8.75**

Grobet Screwdriver Set on Stand

Designed especially for watchmakers. Nickel-plated to prevent rust. Reversible, double-ended blades and threaded ferrules for easy replacement with color identified heads for quick selection. See chart for sizes. Set of seven, nos. 3 to 9 for baguette and pocket sizes, in polished hardwood stand with carborundum stone built into base for sharpening blades and a side compartment for spare blades.

521.0762 **\$69.95**



521.0762

Grobet Screwdriver Set

Color-coded screwdrivers are nicked so they will not rust. Same set of seven as above without stand.

521.0730 **\$41.95**



521.0730

Individual Replacement Screwdrivers and Blades

Diameter	No.	Color	Screwdrivers	Blades
1.50	3	Gold	521.0736/3	521.0735/3
1.28	4	Black		521.0735/4
1.20	5	Green	521.0736/5	521.0735/5
1.00	6	Brown	521.0736/6	521.0735/6
.80	7	Red	521.0736/7	521.0735/7
.70	8	Silver	521.0736/8*	521.0735/8
.60	9	Blue		521.0735/9

Screwdrivers **\$8.70 ea**

Blades **\$17.85 dz**

Set of 7 blades for 521.0730 and 521.0762.

521.0732 **\$11.50**



520.480

Screw Chuck Screwdriver Set

Set of six well-constructed screwdrivers with replaceable blades that are held firmly in the handle by means of screw chucks. Blades are best quality tool steel, which have been heat treated for toughness and long wear. Bodies are plated with non-roll hexagonal swivel heads. 3¹/₂" overall in plastic pouch.

520.480 **\$24.25**

Individual Screw Chuck Screwdrivers and Blades

Blade Size	Screwdriver		Blade only	
	Each	Price	Pk of 3	Price
.100"	521.482	\$6.35	521.492	\$8.75
.080"	521.483	\$6.35	521.493	\$8.75
.070"	521.484	\$6.35	521.494	\$8.20
.055"	521.485	\$6.35	521.495	\$8.20
.040"	521.486	\$6.65	521.496	\$8.20
.025"	521.487	\$7.15	521.497	\$8.20



521.514

Set of 7 Swiss Pattern Screwdrivers

Economical set with steel blades set firmly in metal handles. Hexagonal swivel head prevents rolling. Lengths are proportional with blade sizes 3³/₄" to 2⁵/₈". Swiss pattern screwdrivers, styles 3 thru 9, in plastic box.

521.514 **\$43.35**



521.550 - 521.558

Individual Screwdrivers

Number	Blade Diameter	Style	Price	Number	Blade Diameter	Style	Price
521.521*	.078"	2	\$6.90	521.526*	.031"	7	\$6.65
521.522*	.069"	3	\$6.90	521.527*	.027"	8	\$6.65
521.523*	.060"	4	\$4.15	521.528*	.023"	9	\$11.85
521.524*	.047"	5	\$6.65	521.529*	.019"	10	\$4.50
521.525*	.039"	6	\$3.95				

Grobet Individual Watchmakers' Screwdrivers

Precision-made, with set screw to hold blade firmly. Hexagonal swivel heads prevent rolling. Color banded for size identification. Lengths 4¹/₈" to 3¹/₄" proportioned to blade size.

Number	Diam.	Color	Price	Number	Diam.	Color	Price
521.550	.118"	Brown	\$6.65	521.555	.047"	Red	\$6.65
521.551	.089"	Blue	\$6.65	521.556	.039"	Black	\$6.65
521.552	.078"	Green	\$6.65	521.557	.031"	Yellow	\$6.65
521.553	.065"	Purple	\$6.65	521.558	.023"	Lilac	\$6.65
521.554	.055"	Gray	\$6.65				



520.516



521.462



521.749

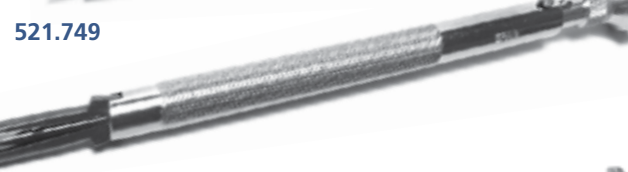

521.850



521.470



521.888

Phillips Screwdriver

2.30mm size is ideal for fitting watch batteries. Hexagon swivel head. India.

520.516 \$1.95 ea 3 @ \$1.75 ea

Double-Ended Phillips Screwdriver

With .060" and .089" reversible blade. Metal body with hexagonal head will not roll.

521.462 \$11.90

521.461 Pk of 3 blades \$19.50

Pick-Up Screwdriver

Super small blade 1.0mm flat designed for watch battery screws. Jaws adjust by spring tension to hold screws securely.

521.749 \$26.60

521.74901* 3 flat 1.0mm Blades \$13.15

521.74904 Clamp w/1.0mm Blade \$19.80

Screw-Holding Screwdriver

Hold screw straight and securely. Self-adjusting jaws. Eliminates stripped threads and lost screws. 4³/₄" long. 2.0mm flat.

521.850 \$20.75

521.852* Replacement Blade \$15.05

521.853* Blade w/Clamp \$18.70

521.855* Replacement Spring \$2.25

Remover - Extractor Set

Set of three includes one each of removers-extractors below.

521.470 \$24.25

Remover	MM	Each	Blades	M/M	Pk of 3
521.473*	2.00	\$8.75	521.476*	2.00	\$10.55
521.472*	1.50	\$8.75	521.475*	1.50	\$10.55
521.471*	1.25	\$8.75	521.474*	1.25	\$10.55

Lantern Chuck Screw Holder

This tool is used to hold a screw by its head allowing you to shorten or round and polish the screw thread end. Includes 3 lantern chucks with hole diameters 0.40, 0.60, 0.80mm. Swiss made by Horotec.

590.907 \$64.95



Grobet Nut & Screw Grabber

With an expandable jaw, this driver grips any size or shape of lock nut, hex nut, star nut, cap nut, or round nut. Also doubles as a screw starter. Placing a screw in the self-closing jaws makes it easy to thread even the smallest screw in to the hardest to reach place. The more pressure you apply, the tighter the grip on the screw.

131.450 \$9.95

10 Piece Nutdriver Set

Pocket-size set contains 10 3¹/₂" plastic color-coded nutdrivers in sizes: 3/32", 1/8", 5/32", 3/16", 7/32", 1/4", 9/32", 5/16", 11/32" and 3/8". Torque handle measures 1" x 3¹/₈".

521.888 \$79.95

Ergonomic Screwdriver Set

Set of five stainless steel screwdrivers on rotating stand. Features a large head, making these screwdrivers ergonomic and functional for finely detailed tasks. Comes with 10 extra blades.

520.006

\$99.95



Five-in-One Screwdriver Set

Set has a swivel head handle and five blades in covered stand. Two sizes each regular and phillips blades, and a pointed punch.

520.963

\$7.75



520.963



520.006

Pocket Screwdriver

Pen size aluminum holder with anodized barrel and pocket clip has a built-in steel chuck to firmly hold screwdriver blades and prevent turning. Five blades (3 standard, 2 phillips) are made of heat treated alloy steel for strength and durability and may be stored inside the barrel. Length 3³/₄".

520.009

\$19.95



520.009

Bergeon 2461 Holder for Sharpening Screwdrivers

Spring action holds screwdriver firmly in place. Steel wheels provide even action when wheeled over sharpening stone.

640.2461

\$38.75

360.885 Economy model, Made in India

\$5.50



640.2461

Genuine Bergeon Screwdriver Sharpener

The ultimate tool for sharpening blades. Features two parallel abrasive cylinders that put the correct curvature on your screwdriver blades. Plus, a square stone is included for flattening the blade tips. Several adapters allow sharpening of all sizes of blades from 0.70 to 2.50mm diameter. Save on buying replacement blades and expect better control of screws without scratching watches. The best sharpening tool you can buy. Swiss made Bergeon 6924. (Screwdriver not included.)

640.6924

\$839.95

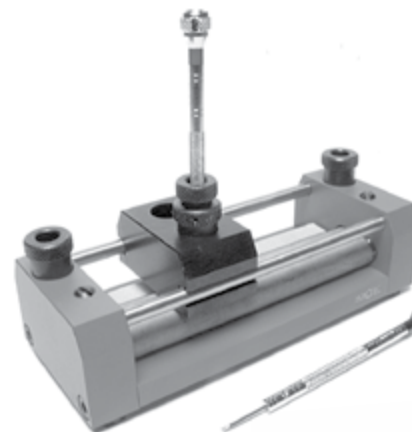

640.6924

Horotec Swiss Screwdriver Sharpener

Restores rounded blades to screwdrivers. Get your screwdrivers in tip-top shape for repairing high range watches with crystal case backs showing the movements and using gold or blued screws. Includes three stones (1 square and two round), three screwdriver holders 4.30, 4.80, and 5.30mm, and users manual.

360.051

\$279.00



360.051



570.830

640.6671.1

640.6671.3

640.6671.5

570.557

640.5000.1EV

640.7029

640.6751.03

640.6751.05

571.244

571.01107

571.01207

571.256

571.309

571.512

ASCO #5 Bronze Tweezers

Swiss made of special non-magnetic bronze alloy. Pattern #5 with smooth sharp tips. 5 1/8" long.

570.830

\$33.95

BERGEON

BERGEON Anti-Magnetic Tweezers

Finest handmade tweezers. Anti-magnetic and anti-acid. Brass Tweezers 570.557 for parts that scratch easily. Swiss.

640.6671.1 Pattern 1 Bergeon 6671-1 **\$32.95**

640.6671.3 Pattern 3 Bergeon 6671-3 **\$34.95**

640.6671.5 Pattern 5 Superfine for Hairsprings 6671-5 **\$28.95**

570.557 Pattern AM Brass Bergeon 1064-AM **\$42.95**

BERGEON #1 Stainless Steel Tweezers

Strong, perfect finish with sharp points. 120mm long. Swiss.

640.5000.1EV

\$20.95

BERGEON Brass Tweezers with Fine Points

Brass coated with a gold flash plating protects against oxidation, preserving the brass. Bergeon 7029-1AM-GF.

640.7029.1AM

\$49.95

BERGEON ESD Carbon Fiber Tweezers

Carbon fiber resists high temperatures and is ideal for handling small delicate components. Cleanroom safe and a great solution when assembly requires care and precision.

640.6751.03 Bergeon 6751-03 **\$4.25**

640.6751.05 Bergeon 6751-05 **\$4.25**

Dumont Handling Tweezers

Excellent for handling all miniature and micro-miniature parts and components. The shape permits hand to rest on the bench during assembly operations. Curved shanks have beveled edges; points have a plain finish, but very sharp. 4 1/2".

Pattern No.7

571.244 Carbon Steel **\$58.05**

Pattern No.7A Blunt Tip

571.01107 Stainless Steel **\$46.00**

571.01207 Anti-Acid/Mag SS **\$38.60**

Pattern No.8

Straightens terminal lead wires, needle point indicators, etc. Blades are extra thick with blunt jaws. Overall length 4 1/4".

571.256 Carbon Steel **\$102.90**

Dumont Cutters Pattern 15, 15A and 15AP

#15 for cutting very soft wire or stripping fine magnet wire. 4 1/4".
#15A most popular wire cutting tweezers. Strong oblique cutting edge gives clean, close cuts on many types of fine wire. 4 1/2" long.
#15AP cuts .010" and smaller soft wire. Parallel cutting edges. 4 1/2".

Carbon Steel Dumont **571.309 (15) \$115.80**

Carbon Steel Dumont **571.312 (15A) \$141.65**

Grobet **571.512* (15A) \$116.70**

Carbon Steel Peer-Vigor **571.515* (15AP) \$135.65**

Stainless Steel Peer-Vigor **571.0715AP* (15AP) \$97.50**

Solid Wood Tweezer Stand

Organize your favorite precision tweezers in this sturdy, solid wood tweezer stand made by Horotec. Holds twelve tweezers on bleacher-style steps, making it easy to find just the tool you need on your bench.

570.801 **\$54.95**

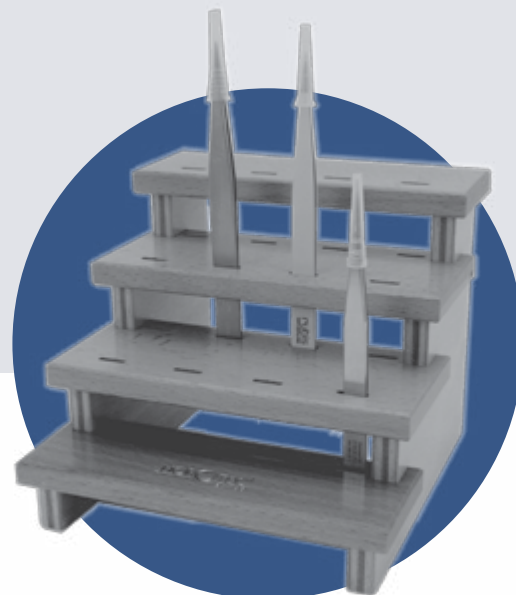

BOLEY Style Tweezers

Boley style are excellent general utility tweezers. All shanks are tapered and have beveled edges, except the GG pattern.

NPS=Nickel Plated Steel, SS=Stainless Steel, AANMSS=Anti-Acid Non-Magnetic Stainless Steel, BO=Black Oxidized.

Pattern AA

For assembly, inspection, sorting, soldering, etc. of small parts. A non glare black oxidized finish is available in this pattern and solder will not adhere to this finish. Overall length 4¾".

Metal	Dumont	Price	Grobet	Price	Economy	Price
NPS	—	—	571.850	\$11.25	570.550	\$3.10
Metal	Dumont	Price	Peer-Vigor	Price	Economy	Price
BO	—	—	571.551*	\$26.90	—	—
SS	571.524	\$38.10	571.553*	\$28.35	—	—
AANMSS	571.525	\$31.50	571.554*	\$32.55	570.854	\$4.25
Titanium	570.435	\$25.95				



Pattern AA



Pattern GG



Pattern MM



Pattern AM



Pattern NN

Pattern GG

Pointed, indented shanks Overall length 5 1/8".

Metal	Dumont	Price	Peer-Vigor	Price
NPS	—	—	571.562	\$31.50
SS	571.01139	\$53.85	—	—

Pattern MM

Similar to pattern AA, but heavier. The shanks are slightly longer and the corner of the handle has been rounded. Overall length 5".

Metal	Dumont	Price	Peer-Vigor	Price	Grobet	Price
NPS	—	—	571.566	\$27.65	571.866	\$10.35
SS	571.526	\$43.40	571.567	\$28.65	—	—
AANMSS	571.527*	\$34.25	571.568*	\$32.55	—	—
Anti-Magnetic PRECITEC	—	—	—	—	570.807	\$13.75

Pattern AM

Non-magnetic brass version of pattern MM. Excellent for handling parts that scratch easily. Overall length 5".

Metal	Economy	Price
Non-Mag Brass	570.556	\$6.50

Pattern NN

Shorter version of pattern MM. Overall length 4½".

Metal	Peer-Vigor	Price
Nickel-Plated Steel	571.570	\$24.95

Orange Tweezers

Swiss Tweezers from Grobet USA®. The satin soft touch provides a comfortable, non-slip grip. These give you symmetry and balance for all normal applications - shaping, adjusting and finishing.

571.162	Pattern #3	\$23.75
571.163	Pattern #3C	\$23.75
571.167	Pattern #5	\$28.70

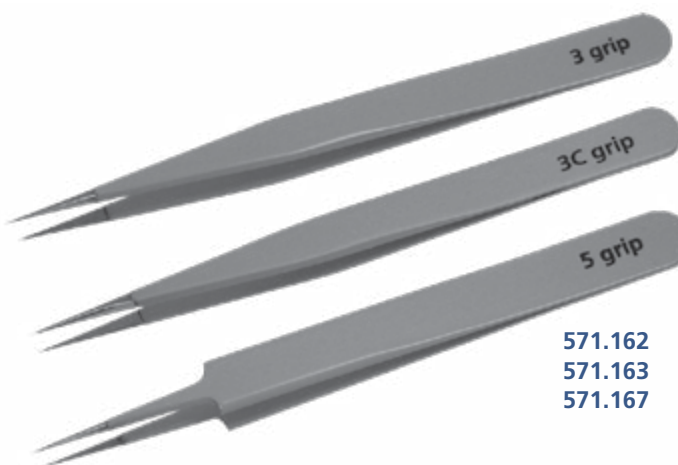

571.162
571.163
571.167



Dumont Watchmakers' Tweezers The Professionals' Choice

Pattern A and AC - #A for general assembly, inspection, etc. Thick shanks with flat edges grip and hold as well as the tip. Plain points, blunt tips are wider than pattern OO. 4¾" long. #AC is similar to #OOC with plain points and slightly wider tips. 4½".

571.284	Carbon Steel A	\$69.05
571.287*	Carbon Steel AC	\$83.35

Pattern H - Stubby, wide shanks for a strong grip on the objects. Used in pairs for wire bending, adjusting, etc. Tapered shanks with flat edges; points are honed and have round blunt tips. 3½" long.

571.259	Carbon Steel	\$94.30
----------------	--------------	----------------

Pattern O - For handling miniature and micro-miniature parts. With tapered shanks, not as thick as pattern OO, flat edges and points that have been honed and are very sharp. 4½" long.

571.01136	Stainless Steel	\$42.00
------------------	-----------------	----------------

Pattern P - Tips are slightly thicker and sturdier than #1. 4¾".

571.296	Carbon Steel	\$55.00
----------------	--------------	----------------

Pattern S - Less expensive than No.3, points not as precise. 4¾".

571.290	Carbon Steel	\$41.65
571.522	Stainless Steel	\$31.90
571.523	Anti-Acid/Non-Mag SS	\$29.25

Pattern SS - Fine, long and narrow points. Overall length 5¼".

571.01244	Anti-Acid/Non-Mag SS	\$38.70
------------------	----------------------	----------------

Pattern OC - Shorter version of pattern O. Overall length 3½".

571.268	Dumont Carbon Steel	\$48.40
571.01130C	Dumont Stainless Steel	\$36.90

Pattern OA - Similar to pattern O, except the shanks are notched and the points have been rounded and finished for fine assembly work. 4¾".

571.273	Dumont Carbon Steel	\$92.20
----------------	---------------------	----------------

Pattern OO - General utility. Thick shanks and flat edges grip as well as the tip. Honed points with blunt tips. 4¾".

570.276	Dumont Carbon Steel	\$46.95
----------------	---------------------	----------------

Pattern OOC - Shorter version of pattern OO. 4½".

571.281	Dumont Carbon Steel	\$48.40
----------------	---------------------	----------------

Pattern OOD - OO with serrations on tips and grips. 4¾" long.

571.489*	Peer-Vigor Carbon Steel	\$53.30
571.490	Peer-Vigor Stainless Steel	\$45.85

Pattern No.11 Dumont Tweezers with Nickel Points
Pattern #11 for general use. High quality Swiss tweezers are made of carbon steel with strong, sharp nickel points. 4¾" long.

641.6603-11		\$42.95
--------------------	--	----------------

Dumont Watchmakers' Tweezers - The Professionals' Choice
Hand Made in Switzerland



Pattern No.1

For general use, assembly, inspection, sorting. Tapered shanks with beveled edges, and sharp, plain-finished points. 4¾".

570.200	Carbon Steel	\$46.90
571.249	Stainless Steel	\$38.70
571.516	Anti-Acid/Mag SS	\$33.40



570.200 571.516
571.249

Pattern No.2

General use tweezers with sturdier points slightly wider and thicker tips than No.1. Indented and have flat edges for gripping object with tip or side. Plain finished points have a fine tip. 4¾".

571.208	Carbon Steel	\$47.30
571.517	Stainless Steel	\$37.80
571.250	Anti-Acid/Mag SS	\$31.95
570.210	Rustless/Non-Mag	\$38.95



570.208 570.210
571.517 571.250

Pattern No.2A

Similar to pattern No.2, except points are .055" wide and rounded at the tips. Overall length 4¾".

571.01102A	Stainless Steel	\$28.95
571.01202A	Anti-Acid/Mag SS	\$31.50



571.01102A
571.01202A

Pattern No.3

Excellent tweezers for handling all miniature and micro-miniature parts. Shanks are tapered with beveled edges; points have been honed and are very sharp. Overall length 4¾".

570.217	Carbon Steel	\$44.95
571.518	Stainless Steel	\$39.90
571.251	Anti-Acid/Mag SS	\$49.95
571.255	Titanium Non-Mag (3 Ti) Stronger then Steel	\$54.95



570.217
571.518
571.251

Pattern No.3C

Popular shorter version of pattern No.3. Length 4½".

570.225	Carbon Steel	\$45.00
571.252	Anti Acid/Mag SS	\$46.95



570.225
571.252

Pattern No.4 (Dumont Style - Vigor-Tek)

Ideally suited for handling microscopic parts. Shanks are indented with beveled edges and points that have been extra-honed to a needle-like shape and sharpness. Overall length 4½".

571.01104	Stainless Steel	\$38.90
------------------	-----------------	----------------



571.01104

Pattern No.5

Similar to No.4 except with very narrow needle-like extra-honed points, shape and sharpness for delicate work. Ideal for handling microscopic parts. Indented shanks with beveled edges. 4½".

570.235	Carbon Steel	\$48.50
571.520	Stainless Steel	\$36.95
570.237	Anti-Acid/Mag SS (same as 571.254)	\$49.95



570.235
571.520
570.237

Pattern No.6

Sharp hooked points for wire wrapping, forming, bending and coiling. Angled points also useful for hard-to-get-at spots. 4½".

571.01106	Stainless Steel	\$71.15
571.01206*	Anti-Acid/Mag SS	\$58.75



571.01106
571.01206



Swiss made Regine Watchmaker's Tweezers

Hand-finished Regine Horlogery Tweezers by VOH are among the finest available, comparable to Dumont and Bergeon quality.

#3 Stainless Steel

4³/₄" long. Excellent for handling micro-miniature parts. Shanks are tapered with beveled edges. Very sharp honed points.

570.301 **\$40.95**

#3C Stainless Steel

4³/₈" long. #3C is a shorter version of pattern #3.

570.302 **\$40.95**

#3C Carbon Steel

Carbon Steel version of above Pattern #3C, 4⁵/₁₆" long.

570.300 **\$39.95**

#5 Stainless Steel

4⁵/₁₆" long. Very narrow needle-like extra-honed points, shape and sharpness for delicate work. Ideal for handling microscopic parts. Indented shanks with beveled edges.

570.304 **\$41.95**

#5 Carbon Steel

Carbon Steel version of above Pattern #5, 4³/₈" long.

570.303 **\$42.95**

PRECITEC®

Anti-Magnetic Tweezers

"Precitec" tweezers are of the finest quality. Available in the three most popular designs for watchmakers. Tapered shanks with beveled edges. Points are honed and very sharp. Anti-magnetic.

570.800 Precitec #3C, 4¹/₄" long **\$13.95**

570.805 Precitec #3, 4⁵/₈" long **\$13.95**

570.806 Precitec #5, 4³/₈" long **\$13.95**

570.807 Precitec #MM, 4⁷/₈" long **\$13.75**

Dumont Ti Titanium Tweezers

Dumont combines its high standards of excellence with the outstanding features of titanium to produce an unequalled set of titanium tweezers. Titanium is a space age metal used in aircraft and resists all types of rust and corrosion. Titanium is 40% lighter than steel and 60% stronger, giving these tweezers a light touch and strong fine points. 100% Non-magnetic.

571.255 Pattern #3 Ti 4³/₄" long **\$54.95**

570.280 Pattern #AA Ti 4⁷/₈" long **\$36.75**

Hi-Tech DUMOSTAR® Tweezers

Swiss made Dumostar® tweezers are manufactured entirely 100% from high-tech steel alloy. Especially appreciated in watchmaking and micro-electronics. Minimum hardness 61 Rockwell at the tips.

- 100% non-magnetic, withstand high temperatures.

- High resistance to corrosion, including hydrochloric acid, nitric and sulfuric acids, neutral and alkaline environments.

570.961 Pattern #3C Fine Points 4⁵/₁₆" long **\$62.95**

570.962 Pattern #5 Super Fine Points 4³/₄" long **\$67.95**

Aluminum tweezers with non-scratch carbon fiber tips

Black strong carbon fiber tips or white soft delrin tips are designed for handling fragile parts without scratching or damaging. Ideal for fitting watch hands. Anti-magnetic. Ultra-light for extended hours of precision work. Patented clip system permits quick, precise tip replacement. 5" long. Swiss.

570.976	Tweezers w/Black Strong Flat Broad Tips	\$27.95
570.977	Tweezers w/White Soft Fine Tips	\$29.95
570.976A	Replacement Tips Black	\$7.30 pr
570.977A	Replacement Tips White	\$7.25 pr
570.978	Replacement Clips	\$4.50 pr

Carbon Tipped Tweezers - ideal for changing batteries

Lightweight aluminum tweezers with non-scratch carbon fiber tips. Designed for handling fragile parts without scratching or damaging. Black strong round serrated carbon fiber tips. Anti-magnetic. Ideal for changing watch batteries. Ultra-light for extended hours of precision work. Patented clip system permits quick, precise tip replacement. Swiss made by Horotec. 4 3/4" long.

570.596		\$32.95
----------------	--	----------------

Tweezers with Boxwood Tips

Stainless steel tweezers are anti-magnetic for manipulating delicate parts. Bergeon 6571-B-1.

640.6571.B.1		\$82.50
---------------------	--	----------------

Vetus Tweezers

Carbon fiber round tips, non-scratch and non-magnetic.

570.599		\$8.50
----------------	--	---------------

Bergeon 6460 Battery Tweezers

Non-conductive plastic tweezers are recommended for handling watch batteries. Flat smooth tips with a very fine nose. 4 3/4" long

640.6460		\$4.25
-----------------	--	---------------

Plastic Tweezers

Glass filled 3/32" side flat tips. Never rusts, easy to sterilize, non-magnetic. Resists acetone, alcohol and acid solutions.

571.958		\$3.20 ea 3 @ \$2.50 ea
----------------	--	--------------------------------

Dumont Ergonomic #5 Anti-Magnetic Tweezers

Features an ergonomic grip and made of steel alloy. Measures 4 1/2.

570.650		\$32.95
----------------	--	----------------



570.976



570.978

570.977



570.596



640.6571.B.1



570.599



640.6460



571.958



570.650

Watchmakers' Tweezers



570.980

F1 Horotec Swiss Tweezers for Watch Hands

Fine quality stainless steel, 100% anti-magnetic. Smooth rounded polymeric tips for working on high grade watches. 4 $\frac{3}{4}$ " long.

570.980

\$59.95

Screw-Holding Tweezers

A cross-slot cut into the tip of the tweezers allows easy pick up of screws or small pieces for placement or examination. Length 4".

571.730

\$6.50

Tweezers for incabloc® Shock Absorbers

Special "genuine incabloc® original" tweezers for holding incabloc shock absorbers. INOX Swiss made.

590.320

\$103.95

Spring Bar Tweezers

Specialty Bergeon tweezers for watchmakers allow bracelet to be removed from the watchcase without removing the clasp.

640.7825

\$169.00

Find more Spring Bar tools on pages 109 - 110.

Crystal Tweezers

Replaceable teflon tips for safe, non-scratch, non-magnetic handling of watch crystals. Avoid getting fingerprints on the crystal with these quality stainless steel tweezers. Bergeon.

640.7140

\$68.00

Find more Crystal tools on pages 86, 94, & 263.

Wire Cutting Tweezers

Nickel plated steel for cutting fine wires used in electrical applications. 3 $\frac{3}{4}$ ". India.

570.860

\$7.25



571.730V



590.320



640.7825

640.7140



570.860

PRIDELINE 12 Piece All-Purpose Kit

Kit contains 4 $\frac{3}{4}$ " Dumont style stainless tweezers:

#1-571.0751, #2A-571.0752A, #3-571.0753, #5-571.0755 and #7-571.0757.

6 $\frac{1}{4}$ " Black non-reflective diamond tweezers 571.0347.

5 $\frac{1}{2}$ " Chrome slide-lock fine diamond tweezers 571.0357A.

5 $\frac{1}{2}$ " Chrome slide-lock medium diamond tweezers 571.0356A.

5" Boley style tweezers #AA-571.0301.

5 $\frac{1}{2}$ " Boley style tweezers #RR-571.0311.

6 $\frac{1}{2}$ " Soldering tweezers 571.0373.

4 $\frac{5}{8}$ " Plastic tweezers 571.958.

Comes in a plastic pouch.

571.01250

\$54.95



571.01250

Dumont Diamond Tweezers

The Professionals' Choice - Hand Made in Switzerland

These quality tweezers have finely serrated jaws to hold stones and small objects firmly. They offer an improved locking system, a superb finish and balance with the legendary Dumont flexibility. They're simply the best stone tweezers in the world. 6 1/2" long for a finer touch and improved balance.



Medium Point Diamond Tweezers

570.005	Stainless Steel	\$31.50
570.008	Black Matte	\$29.95

Medium Point Locking Tweezers

570.007	Stainless Steel	\$42.95
570.009	Black Matte	\$40.95

Dumont Grooved Tweezers

A groove runs down the middle of Dumont's medium point stainless steel tweezers, making it unbeatable for showing larger stones.

570.006		\$37.25
---------	--	---------



570.005



570.009



570.006

Swiss Diamond Tweezers

Superb quality, Swiss-made with serrated points for easy handling of stones. All have an overall length of 6".

Slide Lock

Stainless Steel Fine Points Satin Finish

571.605		\$45.10
---------	--	---------

Slide Lock Tweezers

Nickel Plated Steel Medium Points

571.616		\$54.60
---------	--	---------

Black Diamond Tweezers

High quality, carbon steel tweezers with black finish for optimum diamond visibility. Overall length 6".

571.620*	Slender Style	\$43.95
571.622	Slide-lock Style	\$57.80

Slide Locking Diamond Tweezers

Matte Black Finish Carbon Steel. Fine, serrated points for easy handling of stones. Swiss made. 6 1/4" long.

571.607		\$57.80
---------	--	---------

Rubber Tipped Diamond Tweezers

Self-locking blunt tweezers have a thin coating of rubber on the tips to help keep stones from slipping away. Swiss.

571.975		\$13.50
---------	--	---------



571.605



571.616



571.620*



571.622



571.607



571.975

Titanium Diamond Tweezers

Titanium is stronger and lighter than steel, giving these a light touch. Long-lasting fine point tips have a fine textured finish to grip stones. Non-magnetic and corrosive resistant. India.

570.617		\$15.50
---------	--	---------



570.617



571.590
571.592*
571.594*



571.591
571.593*
571.595



571.601*



571.604*



571.0350
571.0450



571.0351



571.0352

Tweezers with Serrated Tips

Extra high quality European tweezers with finely serrated tips that grip and hold the most delicate objects securely without damage.

Standard Serrated Tweezers

Smoothly polished chromium-plated. Shanks are tapered and have beveled edges.

Medium points	Price	Fine points	Price	Overall Length
571.590	\$23.95	571.591	\$24.20	5 1/2"
571.592*	\$23.05	571.593*	\$21.95	6"
571.594*	\$22.05	571.595	\$25.25	6 3/8"

Curved Points Serrated Tweezers

Slender pattern with very fine points. Overall length 5 1/2".

571.601* Stainless Steel **\$30.40**

Slide Lock Tweezers

Chromium-plated steel, serrated fine points and locking device. 5 1/2".

571.604* **\$34.80**

All-Purpose Tweezers

Corrugated grip with serrated tips. 7" long.

571.0350 Nickel-Plated Steel **\$13.95**

571.0450 Stainless Steel **\$7.95**

Extra long with smooth, curved points. Nickel-plated steel. 6 1/2".

571.0351 **\$8.95**

Extra long with smooth, straight points. Nickel-plated steel. 7".

571.0352 **\$6.60**

571.936



Five Piece All-Purpose Tweezers Kit

Basic set is an ideal way to sample and select the proper type tweezers. Tweezers have hundreds of uses and the vinyl pouch provides handy storage. Kit contains: 4 1/2" pointed No.571.929, 4 3/4" stamp No.571.926, 6" retrieving forceps No.571.917, 6" solder/utility No. 571.721 and 6 1/2" self closing No.571.753.

571.936 **\$39.95**

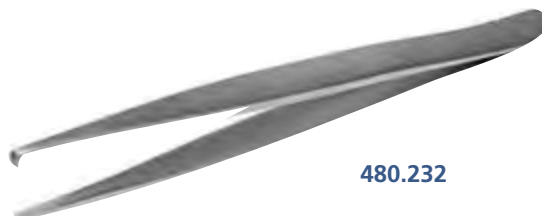

480.232

Split Ring Tweezers

Stainless steel tweezers hold split rings open so you can attach a charm or chain quickly and easily. Measures 4 1/2" long.

480.232 **\$5.50**

Solder/Utility Tweezers

Heavier duty tweezers. Select overall length desired, shape and size of points, with or without serrations, etc.

Small Solder/Utility

Pointed shank. Overall length 4¾". Nickel-plated steel, sharp points.

571.700 **\$7.25**

Pointed shank. Overall length 4¾". Steel, sharp points, satin finish rust-resistant coating.

571.701 **\$9.25**

Indented. Overall length 4¾". Nickel-plated steel, sharp points.

571.705 **\$8.25**

Long Solder/Utility

Indented. Overall length 7". Nickel-plated steel. Wedge/smooth points.

571.713* **\$10.50**

Curved points. Overall length 6¾". Nickel-plated steel. Wedge/smooth points.

571.716 **\$10.30**

Curved, finished points and fine serrations on the handle make these tweezers ideal for even the most delicate objects. 6" long.

Nickel-plated steel. Sharp/serrated points.

571.721 **\$9.50**

Slide Locking

Closing pressure is easily adjusted. Nickel-plated steel.

571.774 Blunt 6½" **\$8.95**

571.772 Rounded/Serrated 6" **\$9.80**

571.770 Sharp/Smooth 4¾" **\$9.75**

Cross-Locking Reverse-Action

570.753 Blunt/Serrated 6½" **\$12.45**

570.752 Sharp/Serrated 6½" **\$17.90**

571.750 Sharp 4¾" **\$7.95**

Head & Shank Tweezers

Slide-locking tweezers securely holds ring shank and setting in position for easy soldering of solitaires. India.

570.0398 **\$8.95**

La Vaque Head & Shank Tweezers

Solder settings accurately the first time, every time. Curved, grooved tip securely holds the shank in place while the transparent glass base secures the head, allowing you to see from the top and all sides for perfect alignment. Glass withstands flame temperatures for gold and silver. Not recommended for platinum and other metals that require higher soldering temperatures. Comes with one extra glass.

570.299 **\$32.95**

570.299.1 Replacement Glass **\$11.75**

Ring Holding Tweezers

Ring holding tweezers hold from inside of shank for easy soldering. Positions two rings being soldered together as a set. India.

480.230 **\$3.95**





570.991

Pearl Tweezers

Specially made tweezers have cupped tips to firmly hold onto beads and pearls. 4³/₈" long.

570.991

\$4.25



570.990

Nylon Tipped Pearl Tweezers

Nylon tip and a dimple in the end enables you to handle beads or pearls without scratching. 6¹/₄".

570.990

\$8.75



571.591

Diamond & Bead Tweezers

For handling delicate beads and findings. Serrated tips. 5¹/₂" long.

571.591

\$24.20

571.821

Knotting Tweezers

For holding and tying knots. Length 4¹/₄".

571.821

\$11.55



570.921

570.922

Large Steaming Tweezers

Extra large tweezers have plastic coated tips for steam cleaning large items. Also for pickling and ultrasonic cleaning (non-scratch retrieving), etc. India.

570.921 8" long

\$5.50

570.922 12" long

\$5.50



571.777

Coated Forceps/Steam Tweezers

Plastic coated tips provides chemical resistance. Use with steam cleaners and ultrasonic cleaners for non scratch retrieving. Nickel-Plated Steel, Cross-lock tweezers hold item securely. 6¹/₂" long.

571.777

\$12.90



570.760

570.761

Soldering Tweezers

Heat resistant fiber grips and permanent tension self-locking jaws are ideal for soldering operations or holding parts. Stainless steel with long, tapered, serrated blunt jaws. 6¹/₂" long. India.

570.760 Straight

\$4.95

570.761 Curved

\$4.95



570.762

Self-Locking Tungsten Tip Tweezers

Handy self-locking tweezers have tungsten tips, which will not contaminate other metals, including platinum. Tips are replaceable. Unit fits nicely onto a third hand base. 7³/₄" long.

570.762

\$43.95

570.762.1 Replacement Tips

\$7.25 pr



570.759

Tweezers leaves your hands free to solder

Heat resistant fiber grips and permanent tension self-locking jaws. Wire stand permanently attached to hold objects above your soldering surface. Long, tapered, serrated jaws. 6¹/₂" long.

570.759

\$5.75

Stone Holders

For gripping and holding loose stones safely. Plunger in handle opens prongs. India.

570.634 Three Prong	\$3.95
570.635 Four Prong	\$3.95
570.637 Pocket Holder 2 1/4"	\$3.95 ea 3 @ \$3.50 ea

Easy Loop Gem Holder

Designed to gently hold a stone so it can be seen by the girdle. This assures the best view without any scratching. 4 1/2" long.

570.638	\$4.25
----------------	---------------



Bead Nabber

Pick up small beads or watch parts with just a touch. Nylon bristles make it easy to collect seed beads and other small items without the risk of falling off your finger. The adjustable ring fits any size finger.

380.121	\$3.95
----------------	---------------

Pick-Me-Up Sticky Tool

The Pick-Me-Up is a sticky tool that lets you pick up tiny items like rhinestones, beads, paper pieces, and more. It's sticky tack helps you to finish all those delicate details in your project.

360.055	\$7.95
----------------	---------------

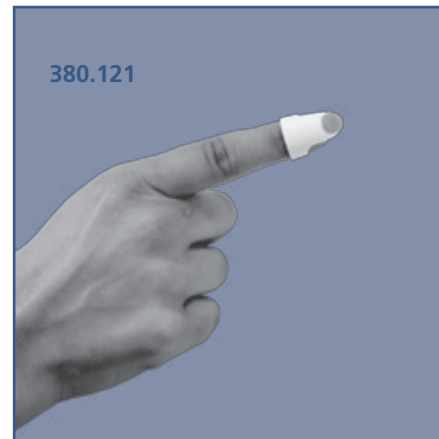

360.055

Tweezers with built-in Magnifier

Stainless steel non-magnetic 00 pattern tweezers with strong points for a variety of uses at the bench. Plastic magnifier adjusts to focus on tips. 5" long overall.

570.012	\$8.50
----------------	---------------

PLEEZERS™ Magnifying Scissors

Add 5X magnifying power to your favorite small scissors or use the included scissors.

530.206	\$6.50
----------------	---------------

PLEEZERS™ Magnifying Thumb Attachment

5X magnifier makes your own hands your most valuable tools. Fully adjustable to fit almost any finger and thumb.

290.308	\$5.25
----------------	---------------



570.012



530.206



290.308

Handy holders for SOLDERING and much more

541.090



540.080

540.081



540.085



540.095



480.405



380.210



460.454

460.456

Third Hand with Tweezers

Heavy, non-tipping bases equipped with ball joint attachments which can position work at any angle. Handy for positioning pieces for soldering or gluing, freeing hands. Cross-locking, 6 1/2" tweezers closes when released. Mounted on heavy-duty round or horseshoe base.

540.080 Round Base **\$17.75**

541.090 Horseshoe Base **\$19.50**

Half-Shank Tweezers hold rings for soldering

Invented by a bench jeweler and made specifically for the difficult task of holding half or quarter shanks in place while soldering with no fumbling or misalignment. Made of stainless steel, this tool is good for other applications where a gentle but firm hold is necessary. Top arm of the tweezers swings out of the way when not used to hold half or quarter shanks. Heavy weighted base.

540.081 **\$21.95**

Third Hand with Alligator Clamps

Two adjustable arms with alligator jaws set in a heavy base. Versatile, adjusts to any position to hold small items firmly.

540.095 Horseshoe Base **\$9.75**

540.085 Round Base **\$26.95**

Holder keeps rings aligned while soldering

Patented Ring Holder from Wes-Gem, makers of the Gem Set Pliers holds rings in perfect alignment while soldering together. Also holds rings for shanks, and, of course, all sizing jobs. Holds items to epoxy, etc. No binding wire or tweezers needed. USA.

480.405 **\$13.25**

Wood Holder won't scratch delicate beads

Handy when using a bead reamer, this wooden hand vise holds beads securely while cleaning or reaming holes. 6 3/4" long.

380.210 **\$6.50**

Stainless Steel Hemostats

Use as a clamp or third hand while soldering small objects. Two position locking device. Box joint prevents looseness and wobble in jaws. Serrations are not sharp and will not cut into soft material.

460.454 6" Straight Tip **\$7.75 ea 3@ \$6.75**

460.456 5" Curved Tip **\$3.95 ea 3@ \$6.75**

Beader's WorkStation keeps all your beading gear organized and in easy reach

Get organized to work easier and faster - enjoy your craft! Great for class or home use. Two shelves for storing beads, wire or anything you need. Lower shelf has a ruler attached. Ten hooks for hanging carded cord. Easy access for pliers, cutters, scissors, shears, tweezers and more. Wood construction, easy to assemble. 22"L x 6³/₄"W x 15"H.

380.332 **\$49.95**

Knotter Tool

Produce a tight, consistent knot every time. Use left or right handed to yield professional results. Works wonderfully with pearls and crystals strung on silk or poly thread. The Knotter Tool does the work of both a beading awl and tweezers, so creating multiple knots is easy.

380.000 **\$26.25**

Diamond Bead Reamer

Versatile, easy to use. Includes small and large diamond reaming points plus 45° edge reamer. Aluminum handle stores points. Brass chuck releases instantly when the collet is unscrewed. Replacement tips available.

530.001 **\$13.80**

Electric Bead Reamer

Smooth rough edges of beads quickly and easily. 1,000 to 20,000 RPM adjustable speed, 24V DC. Compact, lightweight and only 1" in diameter. Includes: Small Point, 45° Edger, Large Diamond Reamer and chucks. Accommodates 1/8" shanks. Always use water when cutting with diamond instruments.

530.300 **\$26.25**

530.3005 Replacement Small Point Diamond Reamer **\$2.30**

Beadsmith Cordless Bead Reamer

Perfect for softening rough edges of beads, and to smooth and enlarge bead holes. Ergonomic handpiece is lightweight and comfortable. Includes: Large and Small Tapered Tips and an Angled tip. Operates at 10,000 rpm on two AA batteries (not included). Always use water when cutting with diamond tools.

530.302 **\$14.25**

Bead Stringing Awl

Designed to slide a knot down into the bead tip or between two beads. Also useful for cleaning holes.

381.330 **\$3.80**

EZ Bracelet™ & EZ Necklace™ jewelry sizers solve sizing problems

The EZ Bracelet bracelet sizer is a must for every beader. Make bracelets that fit the first time, every time. No more re-stringing because it's the wrong size. No more wasted beading wire. No more wasted crimps. No more wasted time. Made of heavy roller polished vinyl for years of beading fun. It's lightweight and easy to assemble too. The EZ Necklace Sizer works just like the EZ Bracelet with measurements from 11" to 27" for sizing necklaces.

350.268 EZ Bracelet Sizer **\$10.95**

350.269 EZ Necklace Sizer **\$10.95**



380.332



380.000

530.001

530.300

530.302

381.330

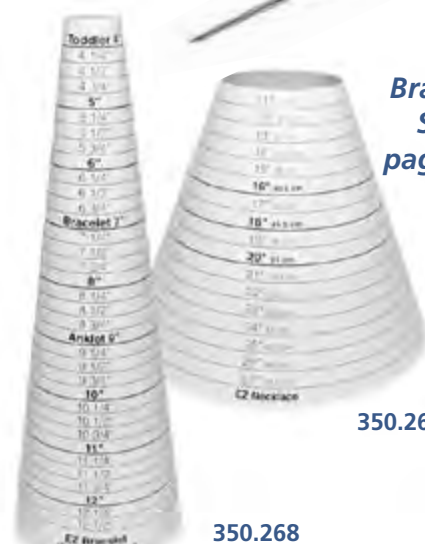

Bracelet & Ring Sizing - see pages 202 - 207.

350.269

350.268



Bead Buddy Workstation and Organizer

A functional storage system designed specifically for beaders. Convenient and portable. Packs up seconds. Store and carry your projects, findings, tools, threads and more in total safety. Includes:

- 18 clear, stackable canisters with easy-open hinged lids.
- Flocked bead board. Large tool compartment.
- Extra storage for books, projects, etc.
- Detachable hinged lids lay flat.
- Durable, high quality construction. Perfect for tabletop or lap.

380.331

\$27.50

The BEADSMITH® Traveler's Bead Board

- Flocked surface helps prevent beads from rolling.
- Removable cover keeps beads in place when you're on the go.
- Recessed sections for sorting beads and findings.
- Specially designed channels that allow you to arrange jewelry projects. Ideal for designing bracelets.
- Measures 7 $\frac{3}{4}$ " x 11 $\frac{1}{4}$ ".

380.040

\$5.50

Imprinted Flexible Mat keeps your beads in place

Plush material keeps your designs in place and beads from rolling. Imprinted with both inch and centimeter marks, this 12 $\frac{1}{2}$ " x 9 $\frac{1}{2}$ " mat is great for the busy beader. Flexible material makes this mat easy to store for traveling. Priced and sold 3 per pack.

380.002

\$4.50 pk of 3

380.331

Removable Cover

Compartments have one slanted side for easy bead removal

380.040



V-shaped channels for snug fit

Measurements in inches and centimeters



380.002



381.01287

Wood Bead Stringing Board

Used to align beads prior to stringing. Grooves are perfectly spaced for organizing work. Measures 22" x 4".

381.01287

\$18.45

Sorting Trays

Sort pearls, stones, findings, etc. Trays have grooves to assist stringing and round indentations for size sorting. 7" x 3 $\frac{3}{4}$ ".

381.102 White **\$6.10**

381.103 Black **\$6.10**

381.103



381.102



150.010

Portable Storage System

Includes 5 stackable 6 $\frac{1}{2}$ " x 1 $\frac{1}{4}$ " donut storage units, each with 5 storage compartments. Made of break and crack resistant translucent plastic.

150.010

\$8.75

Shop our website for Bead Tips, Clasps, Earrings, Bracelets, Watches and more: casker.com

Silk Bead Cord on Spools

Convenient spools make bead stringing so much easier. Spools are 2/3 oz. with length varying with size of cord (thinnest size "A/1" is 630 yds. long, thickest "FFF" is 135 yds).

Number	Color	Size - mm	Number	Color	Size - mm
381.074	White	A - 0.178	381.078	White	F - 0.348
381.075	White	B - 0.203	381.082	Black	F - 0.348
381.076	White	D - 0.305	381.079	White	FF - 0.381
381.077	White	E - 0.325	381.083	White	FFF - 0.419
381.01363	Black	E - 0.325	381.01365	Black	FFF - 0.419

\$9.50 ea

Black Silk Cord Spools EE & D

Silk bead cord on spools makes bead stringing so much easier. Two cord sizes, 2/3 oz. spools.

380.090	"EE" size	\$9.50
380.091	"D" size, Diameter 0.012" / 0.305mm	\$9.50

Nymo Nylon Thread Bobbins

The thread of choice for beadworking and beadweaving. Slightly waxed and lightly twisted. Available black, white, popular colors.

Number	Color	Size	Yds	Number	Color	Size	Yds
380.140	Black	B	72	380.144	Blue	D	64
380.141	Black	D	64	380.154	Royal Blue	B	72
380.142	Black	F	43	380.153	Royal Blue	D	64
380.159	White	B	72	380.152	Light Purple	B	72
380.160	White	D	64	380.151	Light Purple	D	64
380.162	White	F	43	380.157	Turquoise	B	72
380.147	Cream	B	72	380.158	Turquoise	D	64
380.148	Cream	D	64	380.145	Baby Pink	B	72
380.155	Red	B	72	380.146	Baby Pink	D	64
380.156	Red	D	64	380.149	Golden	B	72
380.143	Blue	B	72	380.150	Golden	D	64

380.140 - 380.162

\$1.75 each

Hastings Nylon Spools

Bonded white nylon bead cord has more body, will not unravel, resists wear and knots will not slip. Available in two grades. Plain is more flexible. Lengths vary with size. USA.

Bonded	Plain	Size	Price
—	381.200*	2/0	\$4.85
381.175	381.201	1/0	\$4.85
381.174	381.204	4	\$4.85
	381.205	5	\$4.85

Tuff-Cord

Silk/Nylon mix white bead cord comes in 1/4 oz. spools in 8 sizes.

Number	Size	Price	Number	Size	Price
380.129	0	\$2.95	380.134	5	\$2.95
380.130	1	\$2.95	380.131	2	\$2.95
380.135	6	\$2.95	380.136	7	\$2.95
380.132	3	\$2.95			

Tiger Tail Beading Wire

Stainless steel twisted beading wire coated with nylon. Usually used without knotting for heavy stones and beads and for less expensive bead work. No needle is required. 30 ft spools.

380.326	.012 Fine	3 Strand	\$3.10
380.327	.018 Medium	7 Strand	\$4.10
380.328	.021 Heavy	7 Strand	\$4.30



381.074 - 381.091



380.140 - 380.160



381.174 - 381.205



380.129 - 380.136



380.326 - 380.328



380.110 -
380.118

Griffin Nylon Bead Cord on Cards

Individual cards of fine quality white nylon bead cord with built-in fine needles attached to each cord. Cord is 72" long. Size no. 1/C is thinnest, size no. 8/C is thickest.

No.	Cobb	Size	MM	1-3 @	4-11 @	12 @	100 @
380.110	80-06	1/C	.010	\$1.70	\$1.40	\$1.20	\$1.10
380.112	80-06	2/C	.018	\$1.70	\$1.40	\$1.20	\$1.10
380.113	80-06	3/C	.023	\$1.70	\$1.40	\$1.20	\$1.10
380.114	80-06	4/C	.025	\$1.70	\$1.40	\$1.20	\$1.10
380.115	80-06	5/C	.028	\$1.70	\$1.40	\$1.20	\$1.10
380.116	80-06	6/C	.020	\$1.70	\$1.40	\$1.20	\$1.10
380.118	80-06	8/C	.032	\$1.70	\$1.40	\$1.20	\$1.10



381.021
380.023
380.022

Champion Black Nylon Bead Cord on Cards

72" of twisted nylon bead cord attached to bead needle and mounted on card.

381.021	Size 4	\$1.90
380.023	Size 6	\$2.10
381.022	Size 8	\$1.80



380.030 - 035

Elasticity™ Super Stretchy Cord

Strong, soft and flexible for a variety of popular beading and jewelry applications. Drapes elegantly and retains stretch. Three sizes: 0.5mm, 0.8mm and 1.0mm. 82 feet.

Number	Color	M/M	Price
380.030	Clear	0.5	\$7.25
380.031	Black	0.5	\$7.25
380.032	Clear	0.8	\$7.25
380.033	Black	0.8	\$7.25
380.034	Clear	1.0	\$7.25
380.035	Black	1.0	\$7.25



380.180



Open view of clasp

BeadSmith Rubber Cord Necklace Assortment

Create trendy necklaces with these cords. Each 18" x 2mm soft rubber cord has a plastic tip squeeze-lock mechanism. Add a pendant or beads to give it more charm, or wear it as-is. Package of twenty in assorted colors.

380.180	\$6.95/20
---------	-----------



380.186



BeadSmith Leather Necklace Assortment

Fine quality 18" Greek Leather cord is pre-assembled with a sterling lobster claw clasp. Perfect for quick and easy necklaces. Just add a pendant or beads. Package of one dozen assorted colors.

380.186	\$37.50 dz
---------	------------



51-125-130



52-104



53-105

Bead Crimps

Crimps have an inside diameter of 1.30mm. Available in Yellow Gold Filled & Sterling. Sold in packs of 50 of one color.

51-125-130-7	YGF	\$6.50/50 pk
51-125-130-8	Sterling	\$5.25/50 pk

Bead Tips

Yellow or nickel plated for finishing strands.

52-104-11	YGP	\$7.50/144
52-104-12	NP	\$7.50/144

YGF & Sterling Pearl Clasps

Yellow Gold Filled 15 x 6 mm

53-105-7	YGF	\$2.75
53-105-8	Sterling	\$2.75

Beading Needles

Two sizes quality solid beading needles in packs of 25.

- 380.337** #13 Small **\$6.50/25**
380.339 #10 Large **\$6.50/25**

Stainless Steel Beading Needles 50 per pack.

- 381.0911** Small **\$9.25/50**
381.0912 Medium **\$9.25/50**
381.0913 Large **\$9.25/50**

ScoopEEZ Scoops beads with ease

Perfect for scooping and guiding small beads into containers. Sweep beads with the long edge, slip the pointed end into a container and pour in the beads. 6" long.

- 380.095** **\$4.35**

Thread Cutter

Handy thread cutter lets you cut multiple lengths of thread quickly and easily. Large loop on end can be hung on cord or keychain for quick and easy access. 1 1/4" diameter.

- 380.006** **\$4.25**

Natural Beeswax

100% natural beeswax in a convenient 1oz push-up applicator tube. Perfect for picking up small stones, transferring patterns or to use with bead cord. Unbleached wax leaves little residue.

- 260.104** **\$6.60**

Beeswax Cake & Tube

Makes cord easier to thread. One ounce tube or 1 lb. cake.

- 261.100** 1 oz. tube **\$3.25**
261.103 1 lb. cake **\$17.35**

Thread Conditioner

Developed especially for use with nylon, silk or cotton beading threads. Makes thread slide through beads with remarkable ease. Outperforms beeswax, reduces tangling and stops fraying. Non-toxic, acid free. Leaves no residue.

- 380.108** **\$3.95**

Henrietta's Gum Arabic

Use to make self-threading needles and seal closing knots. Ends tamp in easily for invisible closing. Water soluble. Washes off hands, tools and beads. 1/2 oz.

- 120.024** **\$4.95**

Liver of Sulphur Extended Life Gel

XL Gel is formulated for extended shelf life, versatility and convenience. XL's shelf life is many times that of dry liver of sulphur. Dissolve in hot water or use in its ready form by brushing it onto objects. Apply patina to silver, copper, bronze, brass, metal leaf and metal clay. Non-flammable, contains no acid. 4 fl. oz.

- 451.690** **\$17.95**

Tool Magic

This heavy duty flexible blue rubber coating keeps the tips of your pliers smooth so they won't mar your wire or delicate jewelry parts, and soft so they'll really grip! Just dip the tips of your pliers in Tool Magic and let it dry, finish your project, then peel it off when you're done. 2 fluid ounces.

- 460.000** **\$8.35**



380.337
380.339

381.0911 -
381.0913

380.095

260.104

380.006

261.103

261.100

380.108

120.024

451.690

*"Soften" the
tips of your
pliers*

460.000



430.020 -
430.025



380.059

German Gold & Silver Beading Wire

Beadsmith® Beading Wire with Copper Core, 22, 20 and 18 gauge. Made in Germany.

430.020	Gold	22 Gauge	0.60mm x 10m (10.9 yds)	\$7.95
430.022	Gold	20 Gauge	0.80mm x 6m (6.6 yds)	\$11.50
430.024	Gold	18 Gauge	1.00mm x 4m (4.4 yds)	\$7.95
430.021	Silver	22 Gauge	0.60mm x 10m (10.9 yds)	\$4.15
430.023	Silver	20 Gauge	0.80mm x 6m (6.6 yds)	\$4.15
430.025	Silver	18 Gauge	1.00mm x 4m (4.4 yds)	\$4.15

Soft Touch™ Needles

Our premium quality #10 English embellishment and beadwork needles are exclusively made for Soft Touch Wire .010" diameter. The Soft Touch needle is available in a retail friendly blister card of 16 needles.

380.059 **\$2.15**



380.050
380.051

380.060

Griffin Soft, Flexible Bead Wire

Knot tying, clear HiFlex nylon coated stainless steel wire is like no other. It offers the same great performance as Soft Flex Wire with 50% more supple drape, giving more life and movement to your jewelry designs. Griffin 0.10" (0.25mm) diameter is so thin and flexible it can be threaded onto a special stiff needle and used as a super strong thread. 30 ft long.

Number	Use	Strands	Diam.	Strength	Price
380.060	Weaving/Crocheting	7	.010"	5 lbs.	\$8.95

Fireline® Braided Bead Thread

Fireline® is a prewaxed, braided cord made of gel-spun polyethylene - the strongest fiber per diameter ever created. It has an unbelievably high tensile strength and has been recommended in numerous how-to articles on beadworking. Fireline® will fit a #12 English beading needle. Smoke Grey. 50 yard spools.

380.050	4 lb test .006" diameter	\$8.25
380.051	6 lb test .008" diameter	\$8.25

French Wire

Extra thin coiled wire to finish ends of bead cord. Approximately 16" long.

380.313	Yellow	\$4.95
380.314	White	\$4.95

Creatives™ Plated Memory Wire

- Stainless Steel with Bright Silver Plate.
- 3.60" necklace wire.
- 2.25" bracelet wire.
- 1 oz. = 70 turns for bracelet wire, 38 turns for necklace wire.

430.000	Bracelet Wire 2.25"	\$5.50
430.001	Necklace Wire 3.60"	\$5.50

Perfect End Thread Burner ends the fray of bead thread

Perfect for stopping frayed ends of thread anywhere raw ends need to be eliminated. Cuts and cauterizes! Tip heats to red hot at the touch of a button and melts synthetic threads so that they don't unravel. Uses one AA battery (included). Beaders' ultimate tool.

380.099 **\$24.25**



430.000 - 430.001









380.313
380.314



380.099

JC Class Ring Guards

Yellow Gold Plate or Nickel Plate. "Makes His Ring Fit Her." Adjusts to any size - as fitted. Cannot fall or twist off during active use. Bridge provides strength when reducing from "Large Boys" size to "Little Girls" size. Minimum 1 dozen of a number.

						
Ladies Yellow	Ladies White	Mens Regular Yellow	Mens Regular White	Mens Large Yellow	Mens Large White	
38-400-11	38-402-12	38-404-11	38-408-12	38-406-11	38-410-12	
\$12.75 dz	\$9.00 dz	\$12.75 dz	\$9.00 dz	\$12.75 dz	\$9.00 dz	





Naomi Gold Filled Ring Guards

Yellow or White Gold Filled Shur-Fit Ring Guards prevent slipping. Special tempered gold insures maximum flexibility. Minimum 1 dozen of a number.

				
Ladies Yellow	Ladies White	Mens Yellow	Mens White	
38-010-7	38-010-9	38-020-7	38-020-9	
\$26.00 dz	\$26.00 dz	\$27.95 dz	\$27.95 dz	

14K White Spring Guard

Makes rings slide easily over the knuckle. Bend the flat gold strip in a horseshoe shape and solder to the inside of a ring. All are approximately 44mm (1 3/4") long. Four different widths available. (Yellow gold not available since yellow does not have enough spring.)

			
1.5mm	2.0mm	2.7mm	3.6mm
14K White	14K White	14K White	14K White
11-119-15-2	11-119-20-2	11-119-27-2	11-119-36-2

CALL FOR PRICE 1-800-487-0408.

5% Discount on 3 or more of a number.

14K White Spring Guard Assortment

Assortment has 1 each of 4 widths. 14K White Gold.

11-119-2

CALL FOR PRICE 1-800-487-0408.



Prices on gold items vary with the gold market.

Plastic Ring Guards make rings fit tighter, instantly!

This easy to use ring guard fits inside ring to automatically "size" it smaller. Keeps rings from slipping around fingers. Solves problems of big knuckles. Ideal for class rings. Converts boy's ring to girl's finger size. 38-200 contains 27 (9 widths, each in 3 different heights). 38-308 Assortment contains 3 each of 36 sizes including double sizes for wedding sets. Made in USA.

38-208 Assortment of 108 Plastic Ring Guards **\$47.95**

38-200 Assortment of 27 Plastic Ring Guards **\$12.50**

Refills sold in packs of 3 of a size **\$3.95/3pk**



180.069



Bur-On-A-Handle de-burs wire ends

The one and only tool to effectively de-bur the end of a wire after it has been cut. 1.8mm cup bur does the job with a couple of twists of the hardwood handle. Simple and economical. 5 1/4" long.

180.069

\$5.50

RING GUARDS

"The Spring" Gold Filled Self-Adjusting Ring Guard

Yellow or White Gold Filled. A leaf spring inside the guard adjusts up to 3 ring sizes.

						
2.0 Yellow 38-600-020-7 \$5.75 ea	2.5 Yellow 38-600-025-7 \$5.75 ea	3.0 Yellow 38-600-030-7 \$5.75 ea	3.5 Yellow 38-600-035-7 \$5.75 ea	4.0 Yellow 38-600-040-7 \$5.75 ea	5.0 Yellow 38-600-050-7 \$5.75 ea	
						
2.0 White 38-600-020-9 \$5.75 ea	2.5 White 38-600-025-9 \$5.75 ea	3.0 White 38-600-030-9 \$5.75 ea	3.5 White 38-600-035-9 \$5.75 ea	4.0 White 38-600-040-9 \$5.75 ea	5.0 White 38-600-050-9 \$5.75 ea	

"The Spring" Ring Guard 16-piece Assortment

- Yellow Gold Filled: three 2.0mm, two each 2.5, 3.0mm, one each 3.5, 4.0 and 5.0mm.
- White Gold Filled: one each 2.0, 2.5, 3.0, 3.5, 4.0, 5.0mm.

38-600 \$87.00







Cas-Ker Ring Guards

Yellow or White Gold Filled. Makes oversize rings fit perfectly. Simple to attach. Five sizes cover a complete range. Prices are minimum orders.

				
Ladies Yellow 38-501-7 \$10.50 dz	Ladies Heavy Shank Yellow 38-505-7 \$19.95 dz	Mens Yellow 38-502-7 \$18.85 dz	Giants Yellow 38-503-7 \$13.00 dz	Jumbo Yellow 38-504-7 \$13.95/6
				
Ladies White 38-507-9 \$11.50 dz	Ladies Heavy Shank White 38-511-9 \$12.00 dz	Mens White 38-508-9 \$13.50 dz	Giants White 38-509-9 \$17.50 dz	Jumbo White 38-510-9 \$10.00

W.R. COBB Ring Guards

WRC Quality (1/40 Rolled Gold Plate) Yellow or White, Made in USA. Available in three shank widths. Minimum order WRC quality one dozen of a number.

					
Ladies to 2 1/2mm Yellow 38-61-20-7 \$11.50 dz	Ladies to 2 1/2mm White 38-61-20-9 \$11.50 dz	Mens 2 3/4-5mm Yellow 38-61-21-7 \$15.95 dz	Mens 2 3/4-5mm White 38-61-21-9 \$15.95 dz	King over 5mm Yellow 38-61-22-7 \$24.95 dz	King over 5mm White 38-61-22-9 \$24.95 dz

Ring Cutters let you safely saw rings on or off the finger.

Electric Ring Cutter

In an emergency, speed, safety and comfort are essential. This saw cuts the strongest alloys in less than 10 seconds, safely, without heat or discomfort. Eliminates the old fashioned, lengthy and painful, hand-turned methods. High quality, powerful, battery operated motor is always ready to use. Since it's cordless, you can take it anywhere, so it's ideal in emergencies. The blade guard easily slips under the ring to protect hand and fingers completely. Chrome blade assembly can be sterilized. Lifetime warranty on the unit (exclusive of saw and driver). 4-AA batteries included.

481.0610 **\$336.50**

481.0611 Pk of 2 Replacement Blades **\$89.95**



481.0610

Ring Cutter with Power Screwdriver Axle

Cutter comes with a hexagonal "axle" to use with a standard battery powered screwdriver. Simply replace the manual key turner with the axle and it's ready to use. The consistent, steady power will make the cutting process faster and less painful for the person whose ring is being removed. Made of the finest quality steel.

480.181 **\$48.95**



480.181

Beaver Ring Cutter

Our most popular model. Saws ring while on or off finger. Satin chrome-finished metal parts are set in molded plastic handle with comfort grip design.

481.220 **\$199.95**

481.224 Replacement Saw **\$33.40**

481.225 High Speed Steel Saw for harder alloys only **\$89.95**

481.228* Hub for old style Beaver ring cutter **\$23.70**

481.220



Plier-Style Ring Cutter

Lightweight plier style cutter permits a firm grip on the ring. A few turns of the saw cuts most rings cleanly. Use for removing rings which will not slip off customer's finger. knurled, non-slip handle. Nickel-plated, except for saw.

480.180 **\$46.95**

481.192 Blade only **\$16.35**

480.180



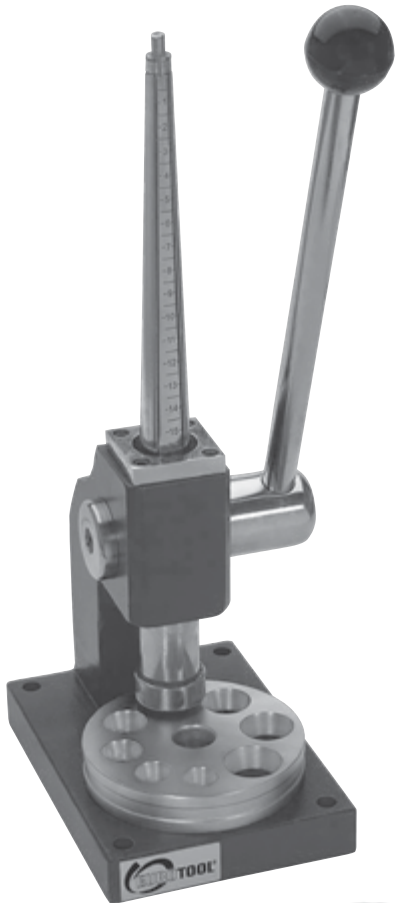

480.352

Deluxe Ring Stretcher

EURO TOOL's Ring Stretcher/Reducer is great quality and a great value!

- Enlarges and reduces rings quickly.
- Tapered 6 spline mandrel clearly marked with ring sizes 1-15.
- Reduction plate is two-sided with 16 reduction depressions.
- Four holes in base for workbench or table mounting.
- Overall height: 16".
- Complete instructions included.

480.352

\$199.95

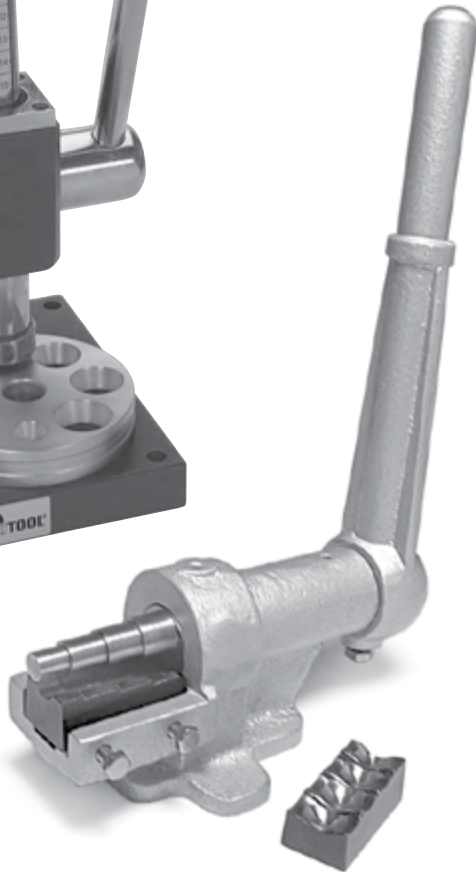

480.050



351.0705

Mark rings to correct size every time with Mark-A-Size

Accurately scribe cutting lines when reducing ring sizes, to avoid errors. 12 sizes are graduated in quarter ring sizes from 1/4 to 3. Mark and cut the correct size every time. Hardened steel with sharp edges. Fan folds when not in use to protect edges. Quickly pays for itself.

351.0705

\$52.00

PEPETools Ring Bender

This rugged tool makes easy work of all your ring bending tasks. Our European ring bender features:

- Heavy-duty cast iron construction.
- Bends flat, oval and half-round blanks up to 4mm thick.
- Includes two precision-machined and hardened forming dies, ellipse shape and half cylinder.
- Mandrel is stepped to accommodate a wide variety of ring sizes and blanks.
- Suitable for production work. Includes mounting bolt.

480.050

\$159.95

Pepetools Ring Bending Tool

This strong, versatile tool outperforms all other ring bending tools. The base and handle performs at a high level of torque while allowing the user to exert less resistance in bending metals. Matching outer dies included.

Improvements over previous model:

- Aluminum machined and powder coated base.
- Dies and post machined from solid steel, then hardened to 40-44 HRC.
- Includes 10 Round Dies: 12mm, 14mm, 16mm, 20mm and 22mm, and 4 Angled Dies: 60° and 90°.
- 24mm Shank for increased durability.

480.317

\$225.00

480.318 Set of 5 different Non-Marring Nylon Dies

\$62.95



480.317
Made in USA



480.318

Economy Stone Set Ring Enlarger

This tool rolls out the shanks of stone set rings to stretch the metal and enlarge the size. Has 8 polished rollers (not as shown) for different sizes and styles of rings. Can also be used on wedding bands. Easy to use, economically priced. India.

480.300

\$82.50



480.300

Ring Stretching Simplified

This simple, easy to use tool for enlarging wedding rings can be used on any size ring, ladies or gents. After ring is placed on stretcher and taper part is inserted, gentle tapping with mandrel causes ring to expand.

480.360

\$22.25

480.360

Rings and Finger Gauge Boxed Set

This matched set includes ring sizes 1 - 15 including half sizes, 30 rings total, 7mm wide. Sizes are stamped in red on each ring. Solid aluminum mandrel includes mm diameters and circumference as well as standard sizes. All in a handsome wooden box.

350.271

\$46.25



350.271

Bangle Gauge

Metal gauge for bangle bracelets measures from size 1 to 27. Stainless Steel, made by Grobet.

351.322

\$3.95



351.322

Bracelet & Bangle Gauge Stand

Gauge for bracelets and bangles. Place bracelet on gauge to measure inside diameter and circumference in inches and mm.

351.325

\$24.95



351.325

See page 193 for more jewelry sizers.



350.262

"Sizing Solutions" let you easily show your customers their ring sizing options

"Sizing Solutions" is a sizing tool that offers your customers a "real feel" demonstration of sizing options in one easy to use set. Perfect for arthritic knuckles, small or hard to fit fingers, top heavy ring designs and hard to size rings. Set of 15 includes sizes 5 through 9 in each guard style; Hinging, Stabilizer & Horseshoe.

350.262

\$39.95



Bracelet Wrist Gauge

Accurately measures bracelet size in centimeters.

350.251

\$13.75



350.251



350.172

Wrist Gauges

Enhance sales of bracelets and bangles. Small or baby sizes 1-9 for infants and children, and Medium sizes 10-18 for small to medium teens and smaller adult wrists.

350.172 Baby Sizes

\$10.95

350.173 Sizes 10-18

\$11.50

Flexible Wrist Gauge

Bergeon accurate and easy to use, made of flexible plastic, graduated in millimeters and inches. A great give-away promotion for bracelet sales. Bergeon 6789-G-10. Pack of 10.

350.250

\$52.50

Plastic Gauge

Remove the correct ring from the plastic form and send it to the manufacturer with an order as an exact template. Eliminates resizing problems caused by inaccurate ring sticks. 23 sizes from 2 1/2 to 14 in half sizes by US standards.

351.0895

\$6.85 dz

Size up sales - size down returns with Multisizer

A great sales aid for your store or catalog operation. Easy to use and inexpensive enough to give away to customers. Plastic sizer wraps around finger to measure up to 17 in whole, half and 1/4 ring sizes. Pack of 25

350.252

\$10.95



350.250



351.0895



350.252

Regular Finger Gauge

Graduated in half sizes by US standards. Bright nickel-plated with colored numerals. Regular width, flat, economy model with matte finish, sizes 1 thru 15.

351.260 **\$13.50**

1/4 Size Finger Gauges

High quality brass sizers are triple plated for long wear. Accurate and easy to read with red markers. 24 quarter sizes from 1¼ thru 12¾.

350.265 **\$15.25**

Wide Gauges

7mm gauges are perfect for fitting wedding rings, class rings, etc. Prevents resizing due to customers twisting narrow gauges over knuckles. Sizes from 1 to 15 by half sizes. Nickel plated brass.

350.264 **\$17.95**

Jumbo Finger Gauge

Now you can measure the BIG guys. Jumbo gauges measure sizes 16 thru 24 in half sizes. Made of nickel plated brass and stamped with red numbers for easy reading. A must for every store.

350.0189 **\$10.50**

Finger Sizers are half-round on the inside for accurate measuring

Set of metal gauges from size 1 thru 15 including half sizes (29 pieces total). Rings are 7mm wide x 2mm thick.

350.090 **\$15.75**

Plastic Finger Sizers

An ideal "Give-Away" for potential customers to take home to determine correct finger size of recipient who cannot be present to be measured. Tag provides a place for your store label.

350.254 **\$2.25**

Maxi-Mandrel

Large steel mandrel is used to make large rings, napkin rings, children's bracelets, round wire jewelry, large stone bezels, etc. Graduated from size 16 to 24 by quarter sizes.

430.055 **\$36.75**

Wire Mandrels form perfect rings

For bead and wire artists who need to make consistent size wire loops. Stainless steel with non-slip PVC handles. Two sizes, each offering five different diameters: Small; 1.5, 2.5, 3.5, 4.5 and 5.0mm, and Large; 6.0, 7.0, 8.0, 9.0 and 10.0mm. Nicely rounded and extremely smooth so wire will not be scratched.

430.057 Small **\$9.95**

430.058 Large **\$10.95**



351.260



350.265



350.264



350.0189



350.090



350.254

*Ring Sanding & Polishing
Mandrels - see page 39*



430.055



430.057



430.058



350.288

Plastic Ring Stick

Black plastic stick for gauging US standard ring sizes 1 - 15. 12" long. India.

350.288 **\$3.95**



350.261

A Better Plastic Ring Stick

Sturdier and more dependable than other plastic sticks, this one accurately measures US sizes 2 through 15. It also features millimeter gauges for diameter and circumference which help determine length of material needed to make a specific ring size.

350.261 **\$5.50**



350.270

Wooden Ring Mandrel

Hardwood stick measures sizes 3 to 15. Hexagon non-roll handle. Non-marring and looks good enough to use at the counter.

350.270 **\$10.95**



431.071

431.070

Combination Mandrel and Rest

Set contains No.431.076 ring mandrel and No.431.070 rest.

431.071* **\$69.95**

Cast Iron Mandrel Rest

Provides support at both ends. Also holds bracelet mandrels that do not have tangs. Can be secured to bench top.

431.070* **\$43.75**

431.050

431.054



Tapered Bracelet Mandrels

For shaping, stretching and forming bracelets and other items. Case hardened, 12". Shipping weight 6 lbs each.

No.	Shape	Small End	Large End	Price
431.050*	Oval	1 ³ / ₈ " x 1 ⁷ / ₈ "	3" x 3 ¹ / ₂ "	\$509.50
431.054	Round	1 ³ / ₄ "	3 ¹ / ₂ "	\$479.00

431.052



Oval Bracelet Mandrel with Tang

For shaping, stretching and forming bracelets and other oval items. Tang fits into anvil Nos.130.325 and 121.0130. Cast steel, polished to a smooth finish. 6" long plus 3" tang. Shipping weight 6 lbs.

431.052 **\$79.95**

350.088

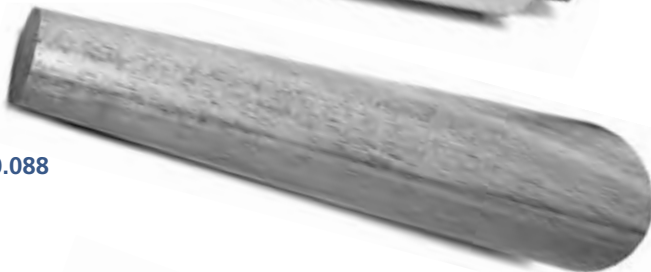

Wooden Bracelet Mandrel

Oval shaped mandrel of solid hardwood is ideal for forming bracelets. 13¹/₂" long tapering from 5¹/₂" to 9¹/₄" circumference.

350.088 **\$30.50**

431.034 - 431.036



Bezel Mandrels

Form bezels and shape decorative ornaments, make chain links, etc. Hardened, tempered steel. 11" overall, mandrel 8" l.

No.	Shape	Small End	Large End	Price
431.034*	Oval	5/32" x 1/8"	5/8" x 1/2"	\$39.95
431.036	Round	1/8"	3/8"	\$41.30

430.085

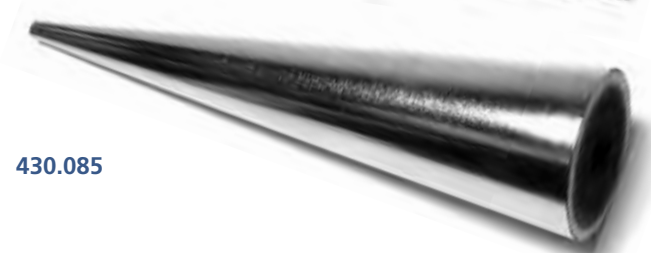

Mandrel for Hoop Earrings

Polished cast iron mandrel for shaping hoop earrings, rings, small bracelets, etc. 12" long, 2" diameter tapers to 3/8" diameter.

430.085 **\$25.25**

Ring Mandrels

Used for shaping, straightening and enlarging rings, plus gauging and holding rings while stone setting. Made of hardened tool steel. Grobet.

431.080	Plain Mandrel	\$25.95
430.076	Graduated non-grooved sizes from 1 to 16	\$27.95
430.077	Grooved for stone set rings, sizes from 1 to 16	\$29.95

Rustless Steel Ring Mandrel

Solid steel mandrel won't rust. Deeply engraved numbers and marks measure rings from size 1 to 5 in quarter sizes to U.S. standards. Non-grooved for shaping, straightening, enlarging, gauging and holding rings while setting stones.

430.078		\$19.50
----------------	--	----------------

Solid Aluminum Ring Sticks

Perfectly finished solid aluminum sticks measure rings from size 1 to 15 in quarter sizes by US standards. Engraved easy-to-read graduations. Each has a ring on the end for hanging.

351.271	Non-grooved	\$17.40
351.272	Grooved	\$17.40

Aluminum Ring Stick

Nicely finished aluminum mandrel measures rings from sizes 1 thru 16 in 1/4 sizes and it has a groove to accommodate stone set rings. 12" long.

350.515		\$15.75
----------------	--	----------------

Easy-to-read Aluminum Ring Stick

The high contrast white numerals on this black anodized stick make it easy to determine an accurate ring size. The ring stick is marked with U.S. sizes 1-15, diameter 13-24mm, circumference 41-76mm and French sizes 1-36.

350.289		\$17.50
----------------	--	----------------

Deluxe Aluminum Ring Stick

Well designed ring stick measures 1 to 15 in quarter sizes to U.S. Standard. Solid aluminum, comfortable rounded handle, features millimeter diameter and circumference scales to show length of material needed to make specific sizes. 9³/₄" long overall. India.

350.291		\$15.50
----------------	--	----------------

Hollow Metal Ring Sticks

Metal sticks with wood handles for gauging US standard ring sizes 1 - 15 in 1/4 sizes. 12¹/₂" long. Grooved or Non-Grooved India.

350.284	Grooved	\$16.50
350.286	Non-Grooved	\$14.75

Bergeon Non-Marring Ring Stick

Highly accurate solid black "Delrin" plastic won't scratch or mar rings. Stick has easy-to-read printed measurements on metal inserts. Marked with U.S. sizes 1-15, diameter 13-24mm, circumference 41-76mm and French sizes 1-36. Swiss made.

640.5236		\$75.95
-----------------	--	----------------



431.080



430.076



430.077



430.078



351.271



351.272



350.515



350.289



350.291

350.284
350.286

640.5236



480.100



481.125



480.120



480.005



480.123



480.002



481.105



481.0700



481.130

Tough Nylon Clamp Outlasts Wood

Double ended with thick leather lined jaws. Outlasts wood many times over. Molded construction assures perfect jaw alignment.

480.100 **\$9.50**

Heavy Duty Hardwood Clamp

Hinge provides long, wobble-free clamp life. One round and one square leather lined jaw. Wedge can be driven into either end to close jaw tight.

481.125 **\$8.95**

Economy Wood Clamp

Hardwood clamp has one square and one round leather lined jaw. Wedge for tightening clamp. India.

480.120 **\$4.15 ea 3 @ \$3.75 ea**

The PEG ASSIST™ Premium Non-Slip Ring Clamp

By Jay Whaley, skilled goldsmith, designer and inventor. Non-slip, extra-long round peg, quality leather-lined jaws, ideal shape for secure hold. Clamp length 6", Peg length 4 3/4". Patent Pending.

480.005 **\$15.75**

Mahogany Ring Clamp with Collar

Collar allows you to station clamp in the v-cut of a bench pin for greater stability and less effort. Thick leather jaws, thick brass band, and metal axle. Made of Philippine red straight-grained mahogany.

480.123 **\$8.75**

130.361 Clamp-on Pin **\$7.40**

Swiss Style Ring Clamp

Aluminum ring clamp has leather lined jaws and a thick rubber cushion grip handle.

480.002 **\$42.95**

Kirkland Ring Clamps

One end clamps from the outside for polishing and stone setting, while the other end holds from the inside for total circumference polishing. Metal conducts heat away from ring. Holds sizes 1-13.

481.105 **\$31.30**

Bench Pin Ring Clamp

Versatile clamp, with lip, fits into solid hardwood bench block for optimum stability. Hard plastic clamp has rubber lined jaws for non-marring grip. Use as a hand held clamp for increased maneuverability.

481.130 Clamp with Lip **\$24.95**

481.0700 Clamp w/Lip & Pin **\$30.50**

131.0202 Bench Pin only **\$5.60**

Gem Set Pliers let you tighten stones without breakage

Set and tighten diamonds and other gems with the unique Gem-Set Pliers. Tightens prongs on all types and sizes of mountings and findings. High leverage of over ten to one is accomplished by a cam type feed. Depth control nut for locked-in safety. Positively safe and will never cause slippage due to pliers wear, as jaw screw links jaws by an indirect cam action. Made in the USA of quality materials - jaws, handle and other parts are made of quality steel and will last a very long time.

460.620

\$45.95



460.620



Gem Set Attachments

These fit in the jaw holes of the Gem Set Pliers and allow you to close all prongs at the same time. Kit includes 4 different sizes for stone setting, a holding nut, and a special holder for earrings. A nice addition for faster, more accurate work.

460.622

\$46.25



460.622

Diamond Setter's Helper

Use this tool to cut equal bearings in prong settings, gent's rings which require hammer settings, and baguette boxes. Also use for routing and modeling. Kit comes with two bur holders and Allen wrench. Bur shank extends through the helper. Larger diameter tool is used on larger surface areas, such as prongs from 10 points to 1/2 carat settings. Small tool for small prongs and cluster settings. For 3/32" Burs.

530.185

\$21.95



530.185

Tube Holders

Seven collets sizes 1/32" to 1/4" firmly hold tubes for stone setting without collapsing. Wood handle with screw chuck.

531.150*

\$29.25



531.150*

Multipurpose Prong Lifter Plus

This prong lifter is titanium coated, making it 5X harder than steel. Opens cabochon settings, and has the additional use as a prong and bezel pusher. Comfortable plastic grip. 5 1/4" long.

530.400

\$36.95



530.400

Swiss Made Prong Lifter

Easily remove stones from ring settings without damaging the prongs or gems. Fine quality in hardened steel with comfort grip. Seven different notches. 4 3/4" long.

530.145

\$73.50



530.145

Prong Lifters

Especially designed to gently and easily pry prongs loose from stones when remounting, resetting or retipping.

530.144 4-1/2" long

\$11.95

530.147 3-7/8" long

\$13.25



530.144

530.147



551.750

Find stone setting supplies on pages 267.

Round Bezel Punch Set

A quality set of 18 tempered punches for precisely and uniformly closing round bezels around stones and prongs. The set includes concave faced punches from .75mm to 7.75mm. Comes in a wooden storage box with a hardwood handle.

551.750

\$39.00



530.140

Bezel Pusher

Grooved steel tool mounted in wood handle for rolling bezels around stones.

530.140

\$6.10



530.146

Prong Pusher

Handy for pushing prongs or crown points around stones. Steel mount in wood handle.

530.146

\$3.25



530.142

Bezel Pusher

For rolling bezels around stones. Grooved steel tool mounted in wood handle. India.

530.142

\$4.00



431.060

Bracelet Holder

Saves time when setting stones, eliminating the need for messy shellac. For prong, pave or channel settings on bracelets up to 7mm wide. Will not mar or distort. Space on outer side for clasps. Aluminum, 3 1/2" diameter. Hex wrench included.

431.060

\$36.95



460.347

More stone setting pliers on page 165.

Zig Zag Setting Pliers let you bend prongs without damaging stones

Invented by a stone setter, these pliers sit at just the right angle to bend prongs over without damaging stones. Box-jointed and made of high grade stainless steel, these little pliers can save you a lot of time and trouble. Overall length 4 3/4".

460.347

\$13.80

K&D Diamond and Stone Gauge

Aluminum pocket gauge for measuring loose stones and settings ranging from .03 points to 4 carats. A birthstone chart is embossed on the reverse side.

351.562 **\$12.60**



351.562

350.470

Quality Folding Gauge

Stainless steel pocket gauge measures round, brilliant, marquise, pear, square, emerald and oval cuts. Only 3 1/2" closed.

350.470 **\$16.50**

Aluminum Gauge

Round holes for stones, round arms for settings. Range 2 to 11mm, 1/32 to 4 cts. Shows mm and corresponding carat.

351.558 **\$17.90**



351.558

Pocket Gauge

Gauge diamonds quickly and accurately. Range .01ct to 2.1ct plus baguettes. Aluminum disks fold together.

350.560 **\$6.75**



350.560

Meleemeeter™ Microgauge System

A valuable and versatile system for evaluating diamonds. Features 10 transparent business card sized gauges with over 575 diamond profiles and sizes. Each profile is identified by its dimensions and carat weight. Use under a microscope in the same position as the stone under inspection. Profile matching eliminates measuring and computing of melee weights. Essential for gauging non-accessible stones. Long-lasting, tough polyester cards in a solid brass case.

350.571 **\$57.95**



350.571

Hole Diameter Sizer

A useful gauge for quick, accurate measurement of inside diameters of drilled holes or nuts. The pinwheel gauge features 10 spokes from 1.0mm to 2.2mm diameter.

351.175 **\$10.05**

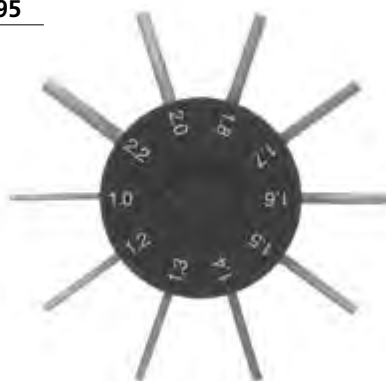

351.175

Wire & Sheet Gauge

Pocket Wire Gauge measures wire and sheet sizes 34, 32, 30, 28, 26, 24, 22, 20, 18, 16, 14, 12, 10 and 8. Each size is also shown in fractions of millimeters and inches. This is the perfect gauge for beaders, wire wrappers and jewelers to easily identify wire or sheet gauge. 3 5/16" x 1" with leather sheath.

350.105 **\$12.95**



350.105



350.674

Genuine BERGEON Crown Gauge for Quartz

Adapted to QUARTZ watches, gauge measures the thread of winding stems and crowns and the diameter of tubes, joints and crowns. Also measures the distance between case lugs.

350.674

\$62.95



590.292

Movement Gauge

Gauge measures in lignes, millimeters and American movement sizes.

590.292

\$4.50

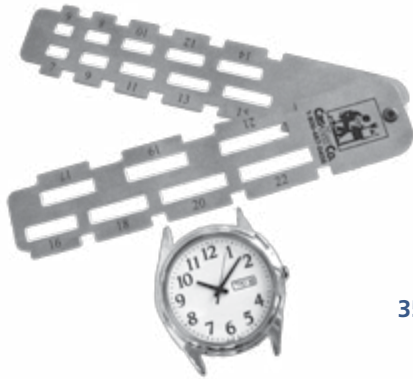

350.159

Stainless Lug Gauge

A simple, easy to use stainless steel tool for measuring watch lug widths 6mm to 22mm. Includes slots for measuring band ends.

350.159

\$14.25

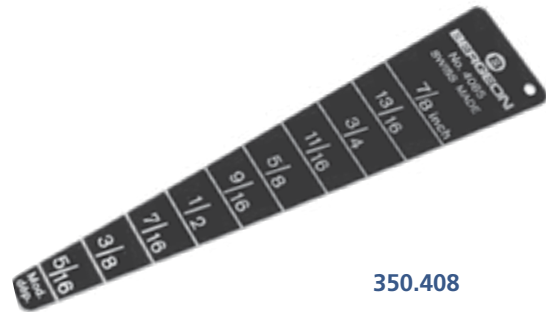

350.408

BERGEON Lug Gauge

Measure between lugs in millimeters and inches. Bergeon 4085.

350.408

\$17.25



351.568

B&S Wire and Drill Gauge

American standard for ordering wire and sheet sizes from O to 36. Decimal equivalents on the back. Imported, economical quality.

351.568

\$42.20

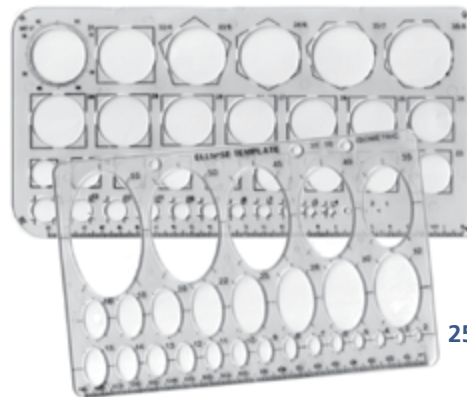

250.000

Circle & Oval Template Set

Two-piece translucent template set.

- 36 Circle templates from 1mm to 36mm
- 27 Ovals from 2mm to 50mm.

Ideal for metal working and other jewelry applications.

250.000

\$6.25

Watchmaker's Precision Micrometer

Precision quality micrometer measures from 0 to 25mm in 0.01mm increments. Thumb lock. 5" long.

350.277**\$134.00**

350.277

**Micrometer**

Fine quality micrometer with 0 to 25mm range. Graduated in 1/100mm. 4 3/8" long. India.

350.124**\$10.95**

350.124

**Digital Micrometer**

Electronic version of the watchmaker's essential. Accurate to 0.001mm. Metric/Inch conversion. Data Hold and Data Output. Relative/Absolute measuring. 0-25mm capacity. 0.001mm resolution. 0.002mm accuracy (0-1" capacity. 0.00005" resolution). Tolerance, Positive & Negative settings. Origin resetting. Operates on one SR44 cell, included. 6 1/4" long. Comes in wooden box.

350.128**\$65.95**

350.128

Presidium Gem Computer Gauge

Premium gauge estimates the weight and identifies gemstones with greater precision and consistency. Covers 74 gemstones and 9 different shapes. Direct carat conversion for round brilliant cut diamonds. Weight computation from direct measurement or through keypad entry. USB interface with PC. CD Rom user guide. Retrieve the specific gravity of a specific gemstone from the S.G. Dictionary by entering the name of the stone. Identify an unknown gemstone by entering the measurement and weight.

340.930**\$319.95**

340.930



340.913*

Presidium Electronic Gem Gauge

Electronic version of the traditional gem gauge. Features increased accuracy of .01mm, push button zeroing, and auto shut-off function. Range 0.00 - 25.00mm. Operates on standard 357 battery. Includes case, weight table, and jewelry attachment for measuring depth of stones in high settings or settings with small holes.

340.913***\$319.95****Presidium Gemstone Dial Gauge**

Enhanced version of the traditional Leveridge Gauge, with color coded dual measurements in millimeters and carats. Precise from 0.0 to 23.0mm in 0.1mm divisions. Direct carat weight reading on dial. Ring size scale on dial. Hardened steel. Attractive case, book and attachment included. Two year limited warranty.

340.912**\$179.95**

340.912



340.909

Economy Master Gauge

This Leveridge style instrument measures inside and outside diameter, depth and thickness of gemstones, pearls (mounted or loose), to an accuracy of better than 1/10mm.

340.909**\$64.95**



350.000

BeadSmith® Compact Digital Caliper

Made from carbon fiber, this 100mm (4") digital caliper is lightweight, and features an automatic shut-off function to protect against battery drain.

350.000

\$15.95



351.182

High-Impact Plastic Dial Caliper

Direct reading 0.01" and 1/64" on dial and mm on bar scale. 6"/150mm capacity. Measures inside, outside, depth and step. Unbreakable, lightweight fiberglass reinforced nylon. Thumb roller with friction stop.

351.182

\$52.95



351.181*

Dial Caliper

Stainless steel. 0-6.5 inches (0 - 165mm). Dial adds .001" to accuracy. Made in China.

351.181*

\$62.95



350.184

Dial Caliper

This caliper has a large 1 1/4" diameter dial that makes it easy to read graduations. Jaw measures inside, outside, step and has depth gauge in end. Economical, unbreakable, shockproof and lightweight. Capacity 150mm in 0.1mm increments. Non-marring nylon will not scratch.

350.184

\$47.50



351.178

Stainless Vernier Caliper

Well-made, precision gauge measures in metric and inch. Capacity 6 1/4" or 179mm. Vernier reads to 1/128" or 1/20mm. Thumb release locks in measurement. Glass-hard inside and outside jaws, with depth gauge in the end. Comes in pouch.

350.178

\$31.50



350.157

Deluxe Brass Gauge

Features a metal underplate which eliminates the problem of holding while measuring. Place a stone or part on the plate and get a fast, accurate measurement up to 80mm (3 1/4"). India.

350.157

\$8.75



350.156

Brass Gauge

Solid brass gauge, combination inch and millimeter. Notched jaws for inside - outside measurements. 1/10 vernier for accuracy. Capacity 80mm (3 1/4"). India.

350.156

\$8.25



350.188

Fiberglass Pocket Caliper

Perfect for measuring rod diameters, plate thickness, inside and outside of tubing. 3" capacity in 32nds and millimeters. 4" rule in 16ths. Unbreakable reinforced fiberglass.

350.188

\$8.75

Digital Electronic Pocket Gauge

Designed with simple functions for accuracy and ease of use. Measures precise inside and outside diameters, all shapes of gems and pearls, mounted or unmounted. Features:

- Measures in inch or millimeter. LCD Display.
- Zero setting at any position. Features a locking screw.
- Compact size, only 3.5" long. Includes carrying case.
- Range: 0-25mm, 0-1.0", Accuracy: 0.01mm, 0.0005"
- Operates on one button cell, included.

350.103**\$62.95**

350.103

**Compact Digital Caliper**

Precision caliper with LCD display measures in millimeters or inches. Capacity 100mm and 4". Accurate to 0.01mm and 0.0005". Features locking screw and return-to-zero function. Measure inside or outside diameters as well as thickness and depth.

Operates on one SR44 cell, included. Comes in its own fitted case.

350.997**\$47.95**

350.997

**Swiss Caliper with Large Easy-To-Read Display**

- Range 0-6" / 150mm, Resolution .0005" / .01mm.
- Accuracy +/- .001" / .02mm.
- Large 18mm High LCD Display.
- MM/inch change at any point. Zero setting in any position.
- Measures inside, outside and depth.
- Simple two button operation with auto-off.
- Operates on one CR2032 cell, included.
- Hardened stainless steel construction. Lock screw, data hold.
- Comes in its own fitted plastic box. Swiss made.

350.187**\$49.95**

350.187

**Cas-Ker Electronic DigiCaliper**

- Measures in inches .0005-6 in. or millimeters .01 - 150mm
- Measures inside, outside and depth.
- Operates on one SR44 cell, included.
- Hardened Stainless Steel construction. Thumb wheel, lock screw, data hold. Comes in fitted plastic box.

350.998**\$43.95**

350.998

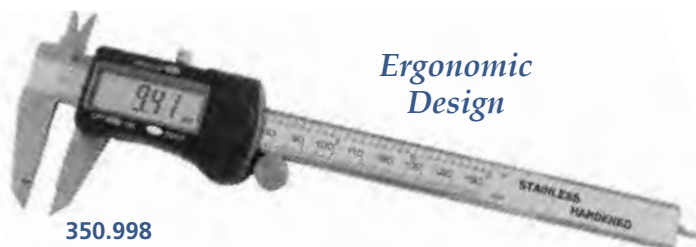
*Ergonomic Design***Fraction+ Digital Fractional Caliper**

Lightweight, non-marring carbon fiber caliper brings you three universal systems of measurement, making it an equally practical choice for both professional and do-it-yourself projects. High-contrast display easily switches between inches, millimeters and fractions, with guaranteed accuracy to 0.001". Inside, outside, depth and step measurements. Range 0-6" (0-150mm). Resolution 0.0005" (0.01mm or 1/64"). Accuracy 0.001" (+/- 0.02mm). Auto Off. Bar scale is graduated in inches and millimeters. Extendable depth gauge for use in slots and small holes. Operates on one LR44, included.

350.123**\$31.50**

350.123

**Caliper Accessory Kit**

Kit for your caliper gauge lets you measure in impossibly hard-to-reach places. Measures slots, grooves, webs, shoulders, holes and pockets. The ball tip provides precision measuring of the thickness of parts. Kit includes two clamps (one has the ball tip and one holds the spindles), and five different size spindles. Attaches to electronic or dial calipers in seconds with thumb screws. Swiss made. Caliper #350.998 sold separately above.

520.600**\$99.95**

520.600



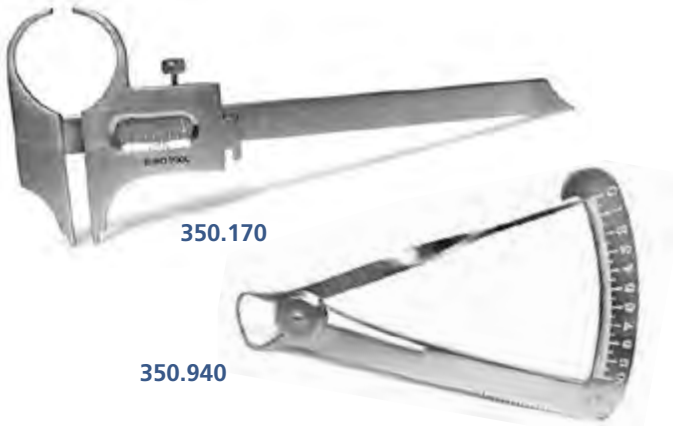

Boley Style Millimeter Gauge

Sliding gauge gives quick measurement of inside or outside diameters with capacity of 100mm and vernier reading to 0.1mm. Cut out jaws for measuring different shapes. Even works on mounted stones. Stainless steel with locking lever. 5³/₄" long.
350.170 **\$12.95**

Degree Gauge

Stainless steel degree gauge for accurate measurements of stones and other small objects. The points are precision ground and accurate to 1/10 of a millimeter. Numbers displayed on both sides.
350.940 **\$10.95**



JO-DI Gauge includes book of diamond tables

JO-DI computes diamond weight while in the mounting

Compute weight of diamond without removing stone from mounting. Widths and depths are measured with caliper and compared with the book of tables. For round and fancy shapes.
351.551 **\$60.80**

Steel Divider

With spring and quick setting nut. 100mm opening. 5" long.
350.087 **\$10.95**



Deluxe Steel Divider

Extra hard tool steel 3" divider with replaceable points. High quality with a heavy duty spring and a quick adjustment nut.
350.081 **\$14.25**

Dividers

Measure distances between points and scribe circles and arcs.
351.0525 4" long **\$10.80**
351.0526* 6" long **\$12.60**

Dividers

For measuring distances between points and scribing circles or arcs. Spring action.

No.	Maximum Opening		Legs		Price
	in	mm	in	mm	
351.086	3 ³ / ₈ "	86	4"	102	\$6.85
351.092	6 ³ / ₄ "	171	6"	152	\$20.75

Divider with Round Legs

For measuring and scribing. High quality construction and finish. Solid nut. Maximum Opening 3³/₄"(83 mm) Legs 3"(76mm).
351.084 **\$115.70**

Opaque Plastic Rule

Graduated in millimeters across top, 1/16" across bottom.
351.500 Length 6", width 1/2" **\$2.25**
351.502 Length 7", width 9/16" **\$2.45**

Stainless Steel Flexible Rule

Graduated in millimeters across the top and 1/32" increments across the bottom. Graduations are deeply etched. 6" x 1/2".
351.510 Rule **\$3.25**
351.510C* Rule with pocket clip (special order) **\$3.25**



351.500*



351.510

A&D Everest Series Legal-for-Trade Precision Jewelry Balances

A&D EK-i Class II Legal-for-Trade Balance

EK-i compact balances provide a large capacity and high resolution. Versatile features include full digital calibration and a large LCD back-lit display. Class II model EK-1200i.

- Capacity: 1200 x 0.1 g, 771.6 x 0.1 dwt, 42,330 x 0.005 oz, 6000.0 x 0.5 ct, 12,000 pcs counting.
- Control zero, mode selection and data output with RS-232C.
- Counting function with Automatic Accuracy Improvement (counting function not legal for trade).
- Full Digital Calibration with optional user definable mass setting (calibration weight not included).
- Liquid Level Indicator helps you quickly and easily level the scale for the most accurate weight readings.
- Conformity to GLP with I.D. and serial number outputs.
- Includes AC adaptor.
- Overload protection. Programmable Auto Power Off or stay on until you turn it off.
- Portable compact size, light weight, rugged body.
- Sealed key panel protection against dust and spills.
- Low profile and small footprint for minimal space requirement.
- Security ring to prevent theft.
- 5 1/4" x 6 3/4" stainless steel platform removes for cleaning.
- NTEP Approved Legal-For-Trade.
- 5 Year Warranty.

510.118

\$389.00

A&D EK-i Class III Legal-for-Trade Balance

EK-i compact balances provide a large capacity and high resolution. Versatile features include full digital calibration and a large LCD back-lit display. Class III model EK-600i.

- Capacity: 600 x 0.1 g, 385.8 x 0.1 dwt, 21.165 x 0.005 oz, 19.290 x 0.005 ozt, 3000.0 x 0.5 ct, 6,000 pcs counting.
- Control zero, mode selection and data output with RS-232C.
- Counting function with Automatic Accuracy Improvement (counting function not legal for trade).
- Full Digital Calibration with optional user definable mass setting (calibration weight not included).
- Liquid Level Indicator helps you quickly and easily level the scale for the most accurate weight readings.
- Conformity to GLP with I.D. and serial number outputs.
- Includes AC adaptor.
- Overload protection. Programmable Auto Power Off or stay on until you turn it off.
- Portable compact size, light weight, rugged body.
- Sealed key panel protection against dust and spills.
- Low profile and small footprint for minimal space requirement.
- Security ring to prevent theft.
- 5 1/4" x 6 3/4" stainless steel platform removes for cleaning.
- NTEP Approved Legal-For-Trade.
- 5 Year Warranty.

510.117

\$324.95

5 YEAR MANUFACTURER'S WARRANTY!

These balances are covered with a 5 year warranty from A&D Weighing against defects in material and workmanship.



510.118

Class II NTEP Approved Legal-for-Trade

The National Conference on Weights and Measure certifies this precision jewelry scale Legal for Trade with Certificate of Conformance Number 04-019. You can count on getting accurate readings time after time. Use this balance to get accurate weights of gold items you buy and sell commercially by weight.



510.117

Class III NTEP Approved Legal-for-Trade

The National Conference on Weights and Measure certifies this precision jewelry scale Legal for Trade with Certificate of Conformance Number 04-019. You can count on getting accurate readings time after time. Use this balance to get accurate weights of gold items you buy and sell commercially by weight.

Check your state's regulations to know which scale class is required for commercial legal for trade use.

Class II Legal-for-Trade 6100 Gram Gold Balance

Model JL6001-G/L. This compact and reliable scale is ideal for retail jewelry applications. Guaranteed accurate results for every weighing job.

- Maximum Capacity: 6100 gram. Readability: 0.1 gram
- Basic gram weighing, piece counting and percent weighing.
- Additional Modes: kg, mg, lb, ct, dwt, oz, ozt and grains.
- USA configured Legal For Trade as required in applications where the product is sold by weight.
- Large back-lit LCD display guarantees easy and secure reading for you and your customers.
- Size of weighing pan: 6.3". Protective cover.
- Battery and AC operation. RS232C and PC interface.
- Assembled in Switzerland.
- Includes two 500 gram calibration weights.
- Must be calibrated before using.

510.109		\$456.95
510.109/A	AC Adaptor for 510.109 Scale	\$65.00

METTLER TOLEDO



510.109

Mettler Toledo scale includes two 500 gram weights.



511.093

238 Gram Calibration Weight Set
238 gram total capacity.
511.093 **\$39.95**

100 Gram Calibration Weight
510.210 **\$17.50**

510.210



511.0906

Pennyweight/Gram Scale

Similar to a Hamilton, this economical scale has pennyweights and grams combined on one scale strip. 40 dwt. (60 g) capacity.

511.0906 **\$22.25**



501.265

1000 gram Bench Scale with large platform

Weighs in grams, ounces, troy ounces and pennyweight.

- Capacity 1000g/0.1g, 35oz/0.01oz, 640dwt/0.1dwt.
- Measures 6¼"W x 7¾"L x 1¾"H.
- Platform 6¼" x 6½".
- Uses a 9 volt battery, included.

501.265

\$46.15

The perfect gold scale for professional jewelers and gold wholesalers. The GemOro Platinum PRO Series offers significantly greater capacity than competitive scales, plus the precision, durability and features you need! Unmatched performance, low profile design, rock solid stability and more - at a real value of a price.

GemOro Platinum® PRO6000 Scale, 6000g x 0.1g

- 6000g x 0.1g, dwt, ozt, oz and lb.
- Push button digital calibration, tare, memory, overload protection and battery saving auto-off.
- Parts counting PCS.
- Large stainless steel weighing platform.
- Precision load cell technology.
- Adjustable feet and leveling bubble indicator.
- Low battery and weight stability indication.
- Large size, adjustable, bright blue backlit LCD display.
- 6½" x 4½" removable, stainless steel weighing platform.
- Removable protective splash guard dust cover.
- Powered by 1 supplied 9V battery or included auto-adjustable, universal voltage 100v-240v AC adaptor.
- Heavy-duty ABS construction with protective paint.
- 5 Year limited replacement warranty.

510.007

\$189.95



510.007



GemOro Platinum® PRO1601 Balance with 1600 Gram Capacity

Leave it to GemOro to create the perfect counter-top / portable gold scale for professional jewelers and gold wholesalers. The Platinum PRO Series offers significantly greater capacity than competitive scales, plus the precision, durability and features you need. Unmatched performance, low profile design, rock solid stability and more - at a real value of a price. It is no wonder that GemOro is the leader in precision weighing for the jewelry industry.

- Weighing modes: g, dwt, ozt, gn and oz, plus parts counting
- Push-button digital calibration, tare, memory, overload protection and auto-off functions.
- Large 5¼" x 5¼" stainless steel weighing platform.
- Extra large adjustable backlit LCD display.
- Durable ABS construction with exclusive protective rubberized Dura-Paint® with removable protective splashguard dust cover.
- Adjustable feet and leveling bubble
- Powered by long-lasting AA alkaline batteries or by its exclusive universal voltage 100v-240v AC adaptor.
- Batteries and stainless steel calibration weight included.
- 5 Year limited replacement warranty.

510.004

\$104.95



510.004



501.251

Grobet 500 Gram/Carat Pocket Scale

Weighs in grams, carats and ounces. Clear plastic cover protects scale and folds flat so larger objects can be weighed.

- Capacity 500g / 0.1g, 17.6oz / 0.001 oz, 2500ct / 0.1ct.
- Parts counting mode.
- Auto calibration and auto off.
- Measures 2¾" W x 4¾" L x 3 / 4" H.
- Uses 2-AAA batteries, not included.

501.251

\$22.00



510.670



Platinum Portable 100 Carat Scale

Gemoro Platinum Model PCT101

- 100ct x 0.005, g, dwt, oz, ozt and gn.
- Parts counting function.
- Large stainless steel weighing platform & bright blue backlit display.
- Push button digital calibration, tare, memory, low battery indicator and battery saving auto-off functions.
- Innovative low profile tinted draft shield manually expands for weighing large diamonds, gemstones and parcels.
- Durable ABS construction with EZ-grip rubberized paint finish.
- Includes a rubberized protective travel/storage case with compartments. containing scale, stainless steel calibration weight, stainless steel weighing platform, scoop, AC adaptor and Swiss-style locking diamond tweezers.
- Powered by (4) long-life included AAA batteries or its supplied universal voltage. 100-240V AC adaptor.
- 5 Year limited replacement warranty.

510.670

\$89.95



510.015



GemOro XP500 - 500 Gram Platinum Pocket Scale

The XP500 from GemOro is our extra precision gold scale with amazing accuracy of 0.01g and the best scale for the job. While most scales have standard accuracy of 0.1g, this amazing scale is 10 times more accurate. It even weighs up to one half kilo. Extra large stainless steel weighing platform too, plus a bright display for easy viewing at any angle or time of day.

- 500g x 0.01g, dwt, ozt, ct, gn and oz.
- Bright blue backlit LCD display.
- Push button digital calibration, tare, memory, low battery indicator and battery saving auto-off functions.
- Powered by (2) included long-life AAA alkaline batteries.
- Includes protective covers, one that also serves as a tray for holding jewelry, findings and more.
- Measures 5" x 4" x 3/4".
- 5 Year limited replacement warranty.

510.015

\$29.95

TOYO

510.150



TOYO 250 Gram Digital Pocket Scale

The popular TOYO scale features a hinged cover, large blue backlit LCD display, Gram, Dwt. and Oz. modes.

- 250x0.1gram,
- 160x0.1dwt,
- 8.75x0.005oz.
- Tare and Auto-off functions.
- Compact: 4 5/8" x 3 1/4" x 3/4" closed.
- Operates on two AAA batteries, included.

510.150

\$26.25

Professional Gold Testers

State-of-the-art electronic gold testing technology from Tri-Electronics. Technological breakthrough that allows for the measurement of low to high karat gold products, assuring the buyer of gold content in the most critical gold alloys. Measures 12" x 10" x 3". UL listed. Three year warranty. Operate on two 9V batteries (not included). These testers do not include AC adapters.

6 to 18 Karat range (model G-XL-18)

561.762*	110 volt Tester	\$549.00
561.762X*	220 volt Tester	\$619.95
561.766	Replacement Gel Tube	\$21.05
561.787	Tri-Wire Assembly	\$6.65
561.783	Replacement Sensor	\$68.25

6 to 24 Karat range (GXL-24 Pro)

561.763	110 volt Tester	\$599.00
561.763X*	220 volt Tester	\$649.95
561.767	Replacement Gel Tube	\$21.05
561.790	Replacement Sensor	\$64.95

Gold Tester (model GT-3000)

The most accurate, low-cost tester available, backed by dependable service and built by Tri-Electronics, the inventor of electronic gold testers. Measures white, yellow, pink and green gold in a full range of values from 6 to 18 karat. No dangerous chemicals or mixing of fluids, so it's ecologically safe. Measures 12" x 9" x 1 3/4". UL listed. Three year warranty. Operates on two 9 volt batteries (not included). Instructional video included.

561.782	110 volt Tester	\$318.30
561.766	Replacement Gel Tube	\$21.05
561.783	Replacement Sensor	\$68.25

Gold Tester (model GT-4000)

Accurately measures white, yellow, pink and green gold, along with platinum, in a full range to 24 karat. Accurate to the nearest karat in the 6 to 18 karat range, plus 20, 22 and 24 karat readings. Ecologically safe with no dangerous acids or messy, harmful chemicals. Measures 12" x 9" x 1 3/4". UL listed. Three year warranty. Operates on two 9 volt batteries (not included). Instructional video included.

561.785	110 volt Tester	\$525.00
561.767	Replacement Gel Tube	\$21.05
561.786*	Replacement Sensor	\$71.40

Pro Cleaning Solution

For cleaning sensor. Prevents buildup that can ruin gel tubes.

561.769*	\$14.50
-----------------	----------------

Sensor Rotary Cap for Tri-Electronic Gold Testers

561.792	\$12.95
----------------	----------------



561.762*



561.763*



561.782



561.785

AuRACLE® AGT3 Digital Gold & Platinum Tester

The advanced digital AGT3 is the ultimate verification instrument for gold and platinum testing. This state-of-the-art portable handheld tester has exceptional precision, is simple to use and in seconds provides accurate results showing both the digital karat value and gold percentage.

- Tests all colors of gold from 6K to 24K and tests platinum.
- LCD display shows both karat value and gold percentage.
- Two test modes: Fast Test Yellow & Enhanced Mode.
- Easy one-step calibration using either 14K or 18K yellow gold.
- Sleek, contoured and ergonomic design.
- Auto-check pen probe function.
- Simply touch pen probe to filed gold or platinum and results are shown in seconds.
- Built-in storage compartment for pen Probe.
- Easy to read LCD display.
- Automatic low battery indicator.
- Easy steps to identify non-gold, gold plate and gold filled as NA.
- Compact and portable.
- Pen probe provides thousands of tests with proper care.
- Scratch resistant nickel plated stainless steel testing plate.
- Powered by 9V alkaline battery or 100V-240V AC Adaptor.
- Includes: AGT3, pen probe, file, battery, AC adaptor and case.



Portable and simple to use.

560.824

Provides accurate results in seconds.

560.824	AGT3 Gold Tester Kit	List Price \$699.00	\$549.00
560.820P3	Replacement Pen Probe for AGT3 only		\$29.95
560.820P	Replacement Pen Probe for AGT1 only		\$29.95
560.820A	110V AC Adaptor Accessory		\$20.95
560.826	14KY Calibration Disc 6.4mm Diameter		\$34.95
560.827	14KY Calibration Disc 9.0mm Diameter		\$49.95



560.812

560.807

560.811



Made in USA

RS MIZAR

MIZAR Electronic Gold Testers

RS MIZAR testers accurately and quickly determine gold karat values of yellow, white, green and red gold shown on their LED display. These units also help identify platinum and can distinguish non-gold or gold plate from true karat gold. Very Reliable, Fast, Safe, Portable and are incredibly simple to use. Made in the USA.

MIZAR ET18 Touchstone™ Tester precisely determines gold karat values equal to or greater than 10K, 14K, and 18K gold, instantly! Ultra-portable, battery operated, pocket size. One Year Warranty.

560.812	Mizar Gold Tester ET18	\$109.95
560.817	Acid	\$27.95

MIZAR M18A9 Electronic Gold Tester precisely determines gold karat values equal to or greater than 8K, 10K, 12K, 14K and 18K. The M18A9 is fully portable, battery operated with an Automatic Shut-Off and Low Battery functions with a full Two Year Warranty.

560.807	Mizar Gold Tester M18A9	\$184.95
560.817	Acid	\$27.95

MIZAR M24 is maintenance-free and automatically determines 9K, 10K, 12K, 14K, 16K, 18K, 20K, 22K and 24K gold. It's fully portable (battery operated) and it has a full Two Year Warranty.

560.811	Mizar Gold Tester M24	\$221.95
560.816	Acid	\$36.25

AuRACLE® AGT Blue Bluetooth™ Mobile Gold & Platinum Tester

The revolutionary and best performing AuRACLE gold tester from GemOro has evolved to a NEW generation in a Bluetooth mobile version that makes it faster, easier and more convenient than ever before. Works with low-energy Apple and Android Bluetooth devices (Note: Android devices require Lollipop version OS or newer.)

- World's best performing gold testing technology with unmatched accuracy
- Compact and pocket sized
- No wires required
- Automatically calculates your unique buying price
- Automatically generates detailed e-mail receipts for both your business and customer
- One touch easy calibration for consistent results
- May be calibrated using 10K, 14K, 18K, 22K, 24K or platinum
- Tests all colors of gold in 10K, 14K, 18K, 22K, 24K and platinum
- Follow easy steps to identify non-gold, gold plate and gold filled as "not gold"
- Simply touch pen probe to gold or platinum for results
- Pen probe provides thousands of tests with proper care
- No messy gel. No staining chemicals. No dangerous acid.
- Includes AGT BLUE™ with built-in testing plate, pen probe, file, carrying case and easy to follow tutorial instructions (mobile device not included)
- One Year Limited Warranty



560.829

\$399.00

Cas-Ker is your complete source for quality testing equipment!

GOLD TESTERS	pages 221-224
GOLD TESTING SUPPLIES.....	page 224
DIAMOND & MOISSANITE TESTERS	pages 225-228
GEM TESTERS.....	page 225
WATCH TESTERS.....	pages 63-67
WATERPROOF TESTERS.....	pages 69-71
BATTERY TESTERS	pages 67-68
CURRENCY TESTER	page 228

Don't see what you're looking for? FIND IT AT CASKER.COM!



560.799 Complete Set

561.748 Box only

560.706 Test Needles

560.710 Test Stone



560.800 - 560.806



151.102



560.711



560.830

Gold Test Kit

A must for purchasing, appraising and testing gold. Solutions for testing silver and platinum are also available. Gold Testing Acid Solutions come in squeeze bottles with color coded caps.

Set Includes:

- **560.800** 10K Testing Solution.
- **560.801** 14K Testing Solution.
- **560.802** 18K Testing Solution.
- **560.706** Set of 3 Testing Needles.
- **560.710** Testing Stone.
- **561.748** Wood Storage Box.
- Instructions and MSD Sheet.

560.799 Gold Test Set (cannot be shipped by air) **\$72.95**

561.748 Wood Storage Box only **\$18.85**

Test Needles for Gold

Used to determine karat content of gold. Needles and item tested are rubbed on test stone and treated with acid to determine match.

561.705* Set of Nine for 4, 6, 8, 10, 12, 14, 16, 18, 20K **\$116.35**

561.707* Set of Five for 8, 10, 12, 14, 18K **\$82.95**

560.706 Set of Three for 10, 14, 18K **\$52.95**

Test Stone

A dark stone on which needle and item to be tested are rubbed. Use with test acid solutions sold above. 1 7/8" x 1 1/2" x 1/4".

560.710 **\$20.95**

Testing Acid Solutions

Gold and silver testing made simple. Accurate results from easy-to-use plastic bottles with secure, color-coded caps.

560.800 for 10K - Yellow Cap **\$4.50**

560.801 for 14K - Green Cap **\$4.50**

560.802 for 18K - White Cap **\$4.50**

560.803 for 22K - Blue Cap **\$4.50**

560.804 for Silver - Red Cap **\$4.50**

560.806 for Platinum **\$4.50**

Acids cannot be shipped by air.

Round Acid Bottle

Frosted edges of this 1 1/2 oz. bottle match the cover, making it suitable for storage, as well as application.

151.102 **\$27.30**

Gold Test Stone in Wood Box

Large 6" x 3" x 3/8" natural stone to test gold, platinum and silver. Simply scratch the piece that you are testing on the stone, then use the appropriate test needle and solution to determine karat value. Comes in a handy premium wood storage box with magnetic closure. Stone is removable to allow use on both sides.

560.711 **\$17.50**

Rare Earth Magnet - a must if you buy and sell gold

Necessary to eliminate ferrous metals in a pile of jewelry. Rare Earth Magnet rated 29lb. Measures 2" x 1/2" x 1/8".

560.830 **\$10.95**

SAM Tester by Presidium

Detects diamonds and moissanites quickly, safely, and consistently. SAM identifies a wide range of moissanites, including the new "low electrical conductivity moissanite." SAM features a highly sensitive thermoelectrical probe, capable of high resolution identification. SAM does its work with the industry's fastest start-up and testing time. Safe - no harmful exposure to the user.

560.738

\$359.00

PRESIDIUM

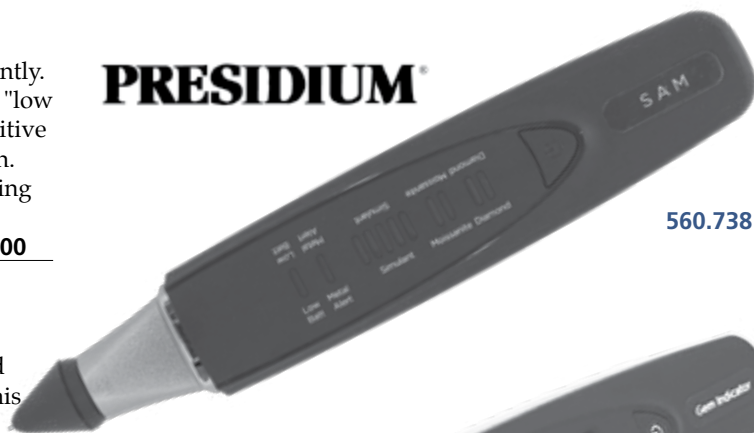

560.738

Colored Gemstone Indicator

The only handheld digital tester created specifically for colored gemstones. Get intelligent results in less than 6 seconds with this simple to use, easy to maintain Presidium Colored Gemstone Indicator. Tests for 31 types of gemstones based on thermal conductivity. Color input function of 12 common colors achieves accurate results. Easy to read clear digital LED screen. Presidium patented refined changeable probe tip ensures minimal equipment downtime. Industry's thinnest probe tip (0.45mm) for testing gemstones from 0.2ct. USB port for alternative power source and connectivity.

561.737

\$279.00



561.737

The Presidium Gem Tester/Color Stone Estimator

Provides a quick, easy, laboratory proven way to identify diamond and separate the most popular colored gem stones from one another. The tester's accurate performance is based on the fact that different gem stones conduct heat at different rates. Simply touch the thermoelectric probe to a mounted or loose stone and the calibrated dial will show the relative heat conductivity of the gem.

- Lightweight, portable and easy to operate.
- Powered by 2-AA batteries or AC adapter provided.
- Easy calibration with two test discs mounted into the frame.
- Solid state probe pen requires no warm up time between tests.
- Built-in metal detector alerts you if mounting is touched.
- One year factory warranty.

590.708

\$299.00

590.708P Replacement Pen Probe

\$57.95



590.708

Presidium Refractive Index Meter II

By accurately measuring the quantity of light reflected through the gemstone, Presidium Refractive Index Meter (PRIM) is able to differentiate between diamonds, moissanites and other colored gemstones via their Refractive Index (R.I.). Unlike a traditional refractometer it is able to measure the range of R.I. value from 1,000 to ~3,000 therefore covering the commonly known gemstones in the market. In addition the fast and easy test can be done without the inconvenience and messy usage of the R.I. liquid, making it quick and easy for you.

- Measures only 5.5" x 3.15" x 1.3".
- Method of Measurement: Reflectivity.
- Measurement Range: 1,000 to ~3,000.
- Method of Measurement: Reflectivity.
- Clear and easy-to-read direct R.I. LCD display panel.
- Software included for further elimination of identity of possible gemstones.
- Compact, portable and handy. Powered either by AC via a USB connection (cord included) or one 9V battery (not included).
- Tests polished gemstones of any shape.
- R.I. Chart Reference and Protective Case included.

590.730

\$329.95

590.730



PRESIDIUM

PRESIDIUM



590.750

Presidium® Adamas Diamond & Moissanite Tester

The world's first diamond and moissanite tester with both replaceable probe tip and micro probe tip (sold separately). Driven by practical innovation and a pursuit of ergonomic aesthetics, the replaceable tip minimizes equipment downtime and the micro tip has the ability to measure even diamond melee as small as 0.01 carats.

- Identifies diamonds, moissanites, simulants, metals instantly.
- Accurate testing on diamonds as small as 0.01ct with optional micro tip (sold separately #590.752).
- Retractable thermoelectric probe tip that ensures constant pressure between probe and gemstone, for enhanced accuracy.
- Ability to store and save test data.
- Light and portable. Simple and easy to use.
- 3-AAA batteries (not included) for 12 hours of operation.
- Power via USB to computer system or power adaptor.
- 7.44" Long x 1.42" Wide x 1.10" High. Weight: 78.5g (2.77 oz)
- Also for use with Presidium® USB Universal Power Adaptor (optional special order item sold separately by Presidium®).

590.750

\$417.95

590.752 Micro Probe Tip

\$77.95



590.891

Presidium Multi Tester III identifies diamonds, moissanite and simulants instantly

The only instrument needed to verify the authenticity of diamonds against moissanite, cubic zirconia, and other diamond simulants. Its probes and circuitries detect data from the gemstone being tested via a customized micro-controller, identifying diamonds and moissanite based on their thermal and electrical properties.

- Retractable thermoelectric probe tip ensures constant pressure between probe and gemstone.
- Thin 0.6mm probe tip tests gemstones as small as 0.02ct.
- Built-in metal alert buzzer. Low battery indicator. Auto-off.
- Uses 3-AAA batteries (not included) or optional AC adapter.
- Includes protective carrying case. One Year Warranty.

590.891

\$312.95

590.891.A3 Optional AC Adapter

\$25.95



590.791

Presidium DiamondMate-C Diamond Tester

LED level meter lights up instantly and an audible beep alerts the user of a successful test. Operates on rechargeable

Nicad batteries or AC adapter, all included. Two second recovery time between tests. Metal detector beeps to alert user of metal contact. One Year Warranty.

590.791

\$159.95



GemOro Testerossa™ Diamond and Moissanite Tester

The ultimate tester for diamond fraud protection! The GemOro Testerossa identifies the widest range of electrically conductive moissanite material, including the new super low electrically conductive moissanite produced by Charles & Colvard Created Moissanite. The Testerossa is the only multi-tester RECOMMENDED by Charles & Colvard.

- Identifies, detects and separates diamond from CZ, moissanite and white sapphire
- Identifies genuine sapphire watch crystals
- Metal alert warning feature informs you if the setting is touched
- LED stone illumination and UV fluorescence detection
- Glowing light bar / probe tip cone for quick stone identification
GREEN = Diamond, BLUE = Moissanite, PINK = Sapphire and RED = Metal Alert
- Sleek ergonomic shape comfortably rests in and on your hand when held
- Intuitive finger grip pads for increased user-friendliness and ease of use
- Precision retractable probe-tip with enhanced durability
- Indestructible polycarbonate housing with molded rubber base for increased impact resistance if dropped
- Fast warm-up time
- User programmable talking voice alert in 9 languages: English, German, Italian, Spanish, French, Russian, Mandarin Chinese, Japanese, Arabic or ringtone sounds
- Powered by micro-USB or with its included 3 AAA rechargeable NiMH batteries (user may substitute 3 AAA alkaline batteries if desired)
- Auto-off function if accidentally left on preserves battery life
- Designed in the USA
- Unprecedented 10-YEAR PROBE TIP WARRANTY
- Lifetime Limited Replacement Warranty on the tester
- INCLUDES: Low-profile GEMORO UltraDock 3 charging station, adjustable GEMORO Test Stone Magnifier attachment, loose stone holder, multi-voltage 100V-240V AC adapter with micro-USB power cord and a carbon-fiber style carrying case.

590.745

\$299.00



590.745



590.869

GemOro ULTRATESTER II® Simultaneous Diamond & Moissanite Tester with White Sapphire Indication

- LED bar graph/beep tone provides audible and visual diamond, moissanite and white sapphire indication.
- Glowing probe tip indicator: DIAMOND = **GREEN**, MOISSANITE = **BLUE** and METAL WARNING = **RED**.
- Ergonomic shape, angled probe tip and grip for ease of use.
- Patented state-of-the-art ULTRA digital electronics.
- Fast warm-up time. Bright white LED illuminator light.
- ULTRAGrip rubberized Dura-Paint finish.
- Exclusive metal warning beep tone indicator.
- Powered by 3 included user-replaceable long-life NiMH rechargeable batteries. AAA alkaline batteries may be used also.
- May be used with GemOro UltraDock™ battery charging stand.
- Battery saving auto sleep mode function.
- Designed in the USA.
- Includes black leatherette case, carrying pouch and instructions.
- Lifetime Limited Warranty.

590.869

\$199.00



590.608

UltraDock™ Charger for second generation GemOro diamond testers

Conveniently designed for recharging the NiMH batteries used in all second generation GemOro UltraTester II and PRO-D II testers. UltraDock may be placed anywhere with your tester inserted, so that it is within easy reach, fully charged at all times and ready for cordless use. The multi-voltage 100-240v AC adaptor/charger supplied with testers is required to power the UltraDock.

590.608

\$24.95



Folding Diamond Light

Space saving folding light design and bright illumination are ideal for grading diamonds. A must for diamond dealers. Full spectrum tube. Black plastic housing. Adjustable shade and auto shut off when folded. Makes a great portable desk lamp too. 19" high.

130.157		\$27.50
130.157B	Replacement Bulb	\$19.50

Portable Gemlight gives diamonds a better grade

Now your customers can actually see for themselves the value they are getting! Gemlight is lightweight, compact and small enough for the professional to grade diamonds and colored stones. It features a 5300-5500 kelvin verilux and UV long wave light, has a deep grading cavity and a 90% cool white background which makes grading diamonds and detecting florescence in colored stones a breeze. Comes with compact case, diamond cloth and bulbs (tweezers not included). Requires four AA batteries. Measures only 6 1/4" x 2 1/4" x 3".

130.338		\$99.95
130.339	Replacement Bulb	\$20.95

GemOro
SUPERIOR INSTRUMENTS



590.704

GemOro CZ Master Set Pro 2™ for Diamond Color Comparison and Grading Featuring Exclusive ColorLast™ Technology!

Professionally color grade diamonds in seconds with GEMORO'S new generation CZ Master Set Pro 2.

- Largest range of reference available: E, F, G, H, I, J, K, L, M and N comparison stones
- 0.50ct 10 stone set expertly hand graded in the USA to master diamond color standards using the GIA grading scale
- Proprietary ColorLast technology to ensure permanent color saturation
- Laser inscribed color ID
- Portable LED illuminated grading and storage case with built-in grading tray
- Natural daylight illumination & UV fluorescence detection
- NiMH rechargeable battery powered with micro-USB charging system
- Includes protective carrying pouch, solitaire ring stone holder set for comparing mounted stones, micro-USB power cord and 100V-240V AC adapter
- Lifetime Limited Warranty against color change

590.704		\$299.00
----------------	--	-----------------



820.860

Money Detector Marker

Specially formulated solution that allows you to verify \$1, \$5, \$10, \$20, \$50 and \$100 bills. A gold "ink" mark verifies legal tender and will disappear in a few days. A black mark warns of a suspect bill and stays until the bill is destroyed. Easy and safe!

820.860		\$7.75
----------------	--	---------------

Gem Stone Display with Acrylic Base

Clear acrylic base with a wire gemstone holder. Just slide the ball to close the prongs on a stone. 7/8" Diameter x 3 1/8" High.

570.639 **\$5.50**

Stone Holder lets your gems "float" for better viewing

Suspend your beautiful gemstones for display so that they can be seen. This visually appealing display unit allows stones to "float". Moreover, the salesperson can remove the display so that customers can see the stone up close. Displays are effective sales tools and economical. Show precious gemstones at their best, suspended alone for maximum viewing.

610.330 **\$5.50**

Gem Stone Display Stand

Gemstone display holder with weighted plastic base measures 6" high. Just slide the small cylinder to open and close the wire loops on a stone.

570.640 **\$6.50**

Easy Loop Gem Holder

Designed to gently hold a stone by the girdle so it can be seen. This assures the best view without possibility of scratching. 4 1/2".

570.638 **\$4.25**

Diamond Presentation Rings

Display diamonds or other precious stones in these rings. Available with regular or long prongs. The best possible way to present loose stones as a sales aide and it's much more secure for customers than tweezers. Attractive and functional.

570.002	Yellow Regular Prongs	\$3.75 ea	12 @ \$3.25 ea
570.003	Yellow Long Prongs	\$3.75 ea	12 @ \$3.25 ea
570.000	White Regular Prongs	\$3.75 ea	12 @ \$3.25 ea
570.001	White Long Prongs	\$3.75 ea	12 @ \$3.25 ea

Tray for Colored Stones

White opaque acrylic tray has eight different size grooves - perfect for sorting and examining colored gemstones. 4" x 2 3/4" x 3/16".

510.095 **\$6.50**

Diamond Sellers

Ideal for closing the sale without using expensive stones. Cubic Zirconia mounted on stainless steel arms fold within a protective cover when not in use. 10 round sizes from 0.10 to 2 carats. Each arm has stone carats and millimeters.

351.555 **\$52.85**



570.639



610.330



570.640

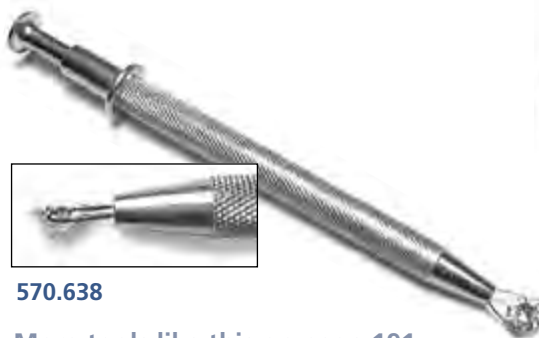

570.638

More tools like this on page 191.
Diamond Tweezers on page 187.



570.001 - 570.003



510.095



351.555



611.0760

Zippered Leather Parcel Paper Box

Gives maximum protection to stones. Fully felt-lined with elastic band to keep papers in proper order. 7"L x 3³/₄"W x 2"D.

611.0760

\$24.75

Large Parcel Box for Stone Papers

Parcel box with hinged lid for diamond and stone papers measures 3³/₄" x 10" x 2" Deep. Adjustable dividers and hook and loop closure.

610.151

\$28.95

Small Parcel Box for Stone Papers

Small parcel box with hinged lid for diamond and stone papers measures 3³/₄" x 4³/₄" x 2" Deep. Adjustable divider and hook and loop closure.

610.150

\$26.95



610.151



130.401

130.403

Diamond Papers

Triple layer folded papers are both super strong and extra soft. For use with all diamonds and stones. 3¹/₈" x 2". Box of 100. India.

130.401 White/White

\$10.95

130.403 Blue/White

\$9.95



610.150

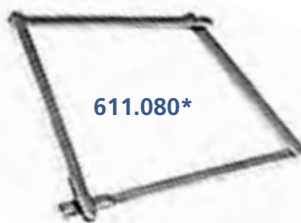

611.080*

Diamond Paper Weight

Holds folded diamond paper in open position. Neatly folds up when not in use. Made of stainless steel. Length 6".

611.080*

\$7.25



560.818*



590.707

Gem Calcite Dichroscope

Easily distinguish garnet from ruby by determining whether a stone is dichroic (reflects 2 colors). Transparent calcite prism lets you view a gem's pleochroic colors simultaneously in sharp contrast. You quickly separate the double refractive ruby from both garnet and red spinel which are singly refractive. High quality dichroscope is resistant to temperature change. A real time saver.

560.818 *

\$62.95

Refractive Index Liquid

Special liquid for refractometers. 1.80 +/- 0.005. 10 grams.

590.707

\$44.95



130.390

Keyring UV Light tests a gem's fluorescence

When gems emit visible light after exposure to short-wave ultraviolet radiation, they are said to be luminescent or fluorescent. A gem is phosphorescent if the luminescence continues after a UV light source has been removed. Fluorescence testing involves cleaning the stone to be tested and then locating a very dark area for observation. The light shines an ultra-violet light with a push of a button. Operates on 3 button cells, included. Never look at the UV light source directly, as permanent eye damage can occur.

130.390

\$16.75

Diamond Wash Cup

Ideal for washing loose diamonds and colored stones with alcohol. Glass jar, 2½" high with 2¼" diameter, has metal screw-on lid with perforated cup suspended inside.

511.098 **\$11.50**

Diamond Sieves

Hand-made sieves to sort rough and polished diamonds. Complete set in handsome zippered carrying case with chart showing plate size of stones per karat, weight and size in millimeters. Each with 21 plates, 0-20.

511.0560 1-7/8" diameter **\$84.95**

511.0565* 2-5/8" diameter **\$129.95**

Diamond Scoop

Aluminum scoop for sorting, gems and small parts. 6¾" long.

510.092 **\$7.50**

Stone Shovel

Helpful in the handling and sorting of melee diamonds and stones.

510.096 **\$2.25**

Sorting Pads

Fine quality white paper with heavy cardboard backing. Bound on three sides, blotter-style to prevent curling or lifting. Pads of 50.

611.0585* 8" x 10" Pads **\$13.40**

611.0586 10" x 12" Pads **\$14.50**

Deluxe Diamond Wallet

Made of fine, black, Moroccan leather designed to fit inside your pocket. With reinforced metal ring, for use with wallet chain for security purposes. Complete with elastic bands to keep wallet closed and flat. Measures 4" x 7".

611.0625 **\$26.25**

Official Jewelry Appraisal Forms

Three-part appraisal form, package of 50.

611.171 **\$24.95**

Handy kit for buying and selling diamonds and gems

Keep this compact kit with you wherever you go. Includes diamond tweezers, scoop, folding eye loupe with neck strap, 4-prong stone holder, lint-free cloth and black acrylic sorting tray all in a secure zippered pouch.

510.099 **\$41.75**



Grobet Swiss Precision Files

Known and recognized throughout the world and unsurpassed for:

- Precise and accurate shapes and sizes.
- Extreme hardness resulting from chrome alloy steel and a unique manufacturing process.
- Exceptional durability.
- The "right" balance and feel.
- In short, the finest files made.



Equalling

Parallel in width and thickness. Used primarily for filing slots and corners. Length listed is working (cut) area. Large numbers are fine cut.

Length	Width	Thickness	Cut 00	Price	Cut 0	Price	Cut 2	Price	Cut 4	Price
4"	13/32"	5/64"	—	—	311.065*	\$24.50	311.066*	\$26.25	311.067*	\$29.25
6"	1/2"	7/64"	311.068*	\$26.75	311.069*	\$28.75	311.070*	\$29.50	311.071*	\$34.35
8"	21/32"	1/8"	311.072*	\$37.25	311.073*	\$39.50	311.074*	\$42.75	—	—



Half-Round Tapered in width and thickness, coming to a point. Cut on both sides. Length listed is cut area. Large numbers are fine cut.

Length	Width	Thickness	Cut 00	Price	Cut 0	Price	Cut 1	Price	Cut 2	Price	Cut 3	Price	Cut 4	Price	Cut 6	Price
3"	5/16"	3/32"	—	—	—	—	—	—	311.100*	\$33.75	—	—	—	—	—	—
4"	15/32"	9/64"	311.102	\$30.50	311.103	\$32.00	—	—	311.104*	\$35.75	311.106*	\$37.95	311.107*	\$41.75	—	—
5"	33/64"	5/32"	—	—	—	—	—	—	311.108*	\$39.25	—	—	—	—	—	—
6"	19/32"	3/16"	311.111*	\$36.95	311.112	\$38.95	311.113	\$37.35	311.114	\$42.00	311.115	\$44.75	311.116	\$48.95	311.117	\$80.25
8"	13/16"	15/64"	311.118*	\$50.75	311.119*	\$53.50	311.120*	\$53.50	311.121*	\$57.75	—	—	311.122	\$67.75	—	—
10"	1"	19/64"	311.123*	\$69.75	311.124*	\$73.75	—	—	311.125*	\$79.75	—	—	—	—	—	—



Half-Round Ring

Tapered in width and thickness, coming to a point. Narrower than regular half-round and, therefore, useful for filing inside of rings. Cut on both sides. Length listed is working (cut) area. Large numbers are fine cut.

Length	Width	Thickness	Cut 00	Price	Cut 0	Price	Cut 1	Price	Cut 2	Price	Cut 3	Price	Cut 4	Price
6"	15/32"	9/64"	311.127	\$38.75	311.128	\$41.25	311.129	\$42.95	311.130	\$44.50	311.131	\$47.25	311.132	\$51.95



Flat or Hand Parallel in width and tapered in thickness. One edge is safe. Length listed is working (cut) area. Large numbers are fine cut.

Length	Width	Thickness	Cut 00	Price	Cut 0	Price	Cut 1	Price	Cut 2	Price	Cut 3	Price	Cut 4	Price	Cut 6	Price
4"	17/32"	1/8"	—	—	311.140*	\$17.25	—	—	311.141	\$18.50	—	—	311.142*	\$21.50	—	—
6"	3/4"	5/32"	311.143	\$20.50	311.144	\$21.75	311.145	\$22.50	311.146	\$23.50	311.147	\$24.75	311.148	\$27.00	311.149	\$41.50
8"	29/32"	3/16"	311.150	\$28.25	311.151	\$29.75	311.152*	\$30.95	311.153	\$32.00	—	—	311.154	\$37.50	—	—
10"	1"	1/4"	311.155	\$38.50	311.156*	\$40.75	—	—	311.157*	\$44.00	—	—	—	—	—	—
12"	13/16"	5/16"	311.158*	\$51.50	311.159*	\$54.75	—	—	—	—	—	—	—	—	—	—



Pillar Checkering

Length	Width	Thickness	Cut 00	Price	Cut 0	Price	Cut 1	Price	Cut 2	Price	Cut 4	Price
6"	1/2"	11/64"	311.040*	\$42.75	311.041*	\$42.50	311.042*	\$44.00	311.043*	\$45.50	311.045*	\$65.25
Lines per inch			20		30		40		50		75	

Grobet Swiss Precision Files



Barrette

Tapered in width and thickness, coming to a point. Only flat side is cut, providing safe edge and top.

Length	Width	Thickness	Cut 00	Price	Cut 0	Price	Cut 1	Price	Cut 2	Price	Cut 4	Price
3"	23/64"	3/32"	—	—	311.021*	\$24.75	—	—	—	—	—	—
4"	1/2"	1/8"	311.022*	\$23.50	311.023*	\$24.95	311.024	\$25.95	311.025	\$26.75	—	—
6"	23/32"	5/32"	311.027	\$27.50	311.028	\$29.25	311.029	\$32.00	311.030	\$32.75	311.031	\$36.95
8"	7/8"	13/64"	—	—	311.032*	\$40.25	—	—	311.033	\$43.50	—	—



Crochet

Tapered in width and gradually tapered in thickness. Used in filing junctions between a flat and curved surface. Useful in developing slots with rounded edges. Length listed is working (cut) area. Large numbers are fine cut.

Length	Width	Thickness	Cut 00	Price	Cut 0	Price	Cut 2	Price
4"	5/16"	3/32"	—	—	311.047*	\$31.00	311.048*	\$33.50
6"	13/32"	9/64"	311.049*	\$34.50	311.050	\$36.50	311.051*	\$39.50
8"	15/32"	11/64"	311.052*	\$47.50	311.053*	\$50.75	311.054*	\$54.50



Crossing

Half-round on two sides, with one side having a larger radius than the other. Tapered in width and thickness. Cut and usable to the point. Used primarily for filing interior curved surfaces. Double radius allows filing at the junction of two curved surfaces or a straight and a curved surface. Length listed is working (cut) area. Large numbers are fine cut.

Length	Width	Thickness	Cut 0	Price	Cut 2	Price	Cut 4	Price
4"	15/32"	9/64"	311.056*	\$45.50	311.057*	\$48.95	311.058*	\$57.50
6"	19/32"	3/16"	311.059*	\$53.50	311.060*	\$57.75	311.061*	\$67.50
8"	13/16"	15/64"	311.062*	\$72.50	311.063*	\$79.75	—	—



Hand Checkering

Parallel in width and gently tapered in thickness. Overcut is parallel to file edges and upcut is 90° to overcut. Useful for putting serrations on knife edges and to obtain a checkered design similar to a gun hand grip. Length listed is working (cut) area. Large numbers are fine cut.

Length	Width	Thickness	Cut 00	Price	Cut 0	Price	Cut 1	Price	Cut 2	Price
6"	3/4"	5/32"	311.035*	\$45.75	311.036*	\$48.25	311.037*	\$50.25	311.038	\$49.00
Lines per inch			20		30		40		50	



Knife

Tapered in width and thickness, with the knife edge having the same thickness from point to shoulder. The included angle of the sharp edge is approximately 10°. Generally used to file in a slot or wedge shaped opening. Curved edge allows easy filing in restricted areas.

Lgth	Width	Thick	Cut 00	Price	Cut 0	Price	Cut 1	Price	Cut 2	Price	Cut 4	Price
4"	15/32"	1/8"	311.174*	\$25.95	311.175*	\$27.25	311.176*	\$28.50	311.177*	\$29.50	311.178*	\$34.50
6"	23/32"	5/32"	311.179*	\$30.50	311.180*	\$32.00	311.181*	\$33.75	311.182*	\$34.75	311.183*	\$40.50
8"	7/8"	13/64"	311.184*	\$41.75	311.185*	\$44.25	311.186*	\$46.50	311.187*	\$47.75	—	—

Grobet Swiss Precision Pillar Files

These files are parallel in width and tapered in thickness to make possible perfectly flat filing.
Length listed is working (cut) area. Large numbers are fine cut.



Extra Narrow Pillar

Lgth	Width	Thick	Cut 00	Price	Cut 0	Price	Cut 1	Price	Cut 2	Price	Cut 4	Price	Cut 6	Price
3"	1/8"	5/64"	—	—	—	—	—	—	311.200*	\$22.50	—	—	—	—
4"	5/32"	5/64"	311.201*	\$20.25	311.202*	\$21.50	311.203*	\$11.25	311.204*	\$23.00	311.205*	\$26.95	—	—
6"	13/64"	1/8"	311.206*	\$23.75	311.207*	\$25.25	311.208*	\$26.50	311.209*	\$27.25	311.210*	\$31.75	311.211*	\$52.00
8"	9/32"	9/64"	311.212*	\$34.95	311.213*	\$34.50	311.214*	\$36.50	311.215*	\$37.50	311.216*	\$43.75	—	—
10"	11/32"	11/64"	311.217*	\$45.25	—	—	—	—	—	—	—	—	—	—



Narrow Pillar

Lgth	Width	Thick	Cut 00	Price	Cut 0	Price	Cut 1	Price	Cut 2	Price	Cut 4	Price	Cut 6	Price
4"	3/16"	3/32"	311.219*	\$21.50	311.220*	\$22.75	311.221*	\$23.50	311.222*	\$24.50	311.223*	\$28.50	—	—
6"	1/4"	9/64"	311.224*	\$25.75	311.225*	\$26.75	311.226*	\$30.95	311.227*	\$28.95	311.228*	\$33.75	311.229	\$54.75
8"	11/32"	11/64"	311.230*	\$34.50	311.231*	\$34.95	311.232*	\$38.50	311.233*	\$30.00	—	—	—	—
10"	25/64"	3/16"	311.234*	\$47.75	311.235*	\$50.50	—	—	—	—	—	—	—	—



Regular Pillar

Lgth	Width	Thick	Cut 00	Price	Cut 0	Price	Cut 1	Price	Cut 2	Price	Cut 3	Price	Cut 4	Price	Cut 6	Price
4"	3/8"	1/8"	311.237*	\$18.70	311.238*	\$20.10	311.239*	\$20.00	311.240*	\$20.50	—	—	311.241*	\$24.50	—	—
6"	1/2"	11/64"	311.243*	\$21.50	311.244*	\$22.50	311.245*	\$23.50	311.246*	\$19.50	—	—	311.248*	\$28.25	311.249	\$46.25
8"	19/32"	13/64"	311.251*	\$29.25	311.252*	\$30.95	311.253*	\$34.95	311.254*	\$33.50	311.255	\$35.50	311.256*	\$39.00	—	—
10"	23/32"	15/64"	311.257*	\$40.25	311.258*	\$42.75	—	—	311.259*	\$45.75	—	—	—	—	—	—
12"	25/32"	9/32"	311.260*	\$54.00	311.261*	\$57.00	—	—	—	—	—	—	—	—	—	—



Pippin
Tapered in width and thickness. Combines the cross-sections of the round file, with the crossing file, along with the edge of a knife file. For finishing the junction of two different curved surfaces and for opening slots when a "V" shape is required.

Length	Width	Thickness	Cut 00	Price	Cut 0	Price	Cut 2	Price	Cut 4	Price
6"	25/64"	9/64"	—	—	311.267*	\$69.50	311.268	\$75.00	311.269*	\$87.25
8"	15/32"	11/64"	311.270*	\$73.75	311.271*	\$99.00	311.272*	\$103.25	—	—



Screwhead with Tang

Used for filing slots in small screws. Available in thicknesses ranging from No. 1 (thickest) to No. 8 (thinnest).

Length	Width	1 (.032")	Price	2 (.028")	Price	3 (.024")	Price	4 (.022")	Price	6 (.018")	Price	8 (.014")	Price
3"	25/64"	—	—	311.332	\$40.00	311.333*	\$40.00	311.334	\$40.00	311.335	\$40.00	311.336	\$40.00
4"	15/32"	311.337*	\$43.95	311.338*	\$43.95	—	—	—	—	—	—	—	—



Slitting
Parallel in width and thickness. Thinner than knife files and used for filing slots. Length listed is working area. Large numbers are fine cut.

Length	Width	Thickness	Cut 0	Price	Cut 2	Price
6"	19/32"	1/8"	311.342*	\$57.25	311.343*	\$61.25

Grobet Swiss Precision Files

Length listed is working (cut) area. Large numbers are fine cut.



Square

Gradually tapered and cut on all four sides. A general purpose file, cut and usable to the point. B - Indicates blunt end

Length	Width	Cut 00	Price	Cut 0	Price	Cut 1	Price	Cut 2	Price	Cut 4	Price
4"	5/32"	B 311.345*	\$17.95	B 311.346*	\$18.95	311.347*	\$16.75	311.348*	\$21.50	—	—
6"	15/64"	B 311.349*	\$22.25	B 311.350*	\$23.50	311.351*	\$25.25	311.352*	\$25.25	311.353*	\$30.50
8"	5/16"	B 311.354*	\$28.95	B 311.355*	\$30.75	—	—	311.356*	\$34.95	—	—
10"	13/32"	B 311.357*	\$39.95	—	—	—	—	311.358*	\$32.75	—	—



Three-Square

Gradually tapered, cut and workable to the point. Length listed is working (cut) area. Large numbers are fine cut.

Length	Width	Cut 00	Price	Cut 0	Price	Cut 1	Price	Cut 2	Price	Cut 4	Price
3"	13/64"	—	—	311.363*	\$13.25	—	—	311.364*	\$13.50	311.365*	\$13.95
4"	9/32"	311.366*	\$20.50	311.367*	\$21.75	311.368*	\$22.95	311.369*	\$23.50	311.370*	\$27.50
6"	3/8"	311.371*	\$24.50	311.372*	\$25.75	311.373*	\$26.75	311.374*	\$27.75	311.375*	\$32.50
8"	1/2"	311.376*	\$33.50	311.377*	\$35.50	311.378*	\$36.95	311.379*	\$36.35	—	—



Three-Square Slim Same as three-square, except thinner, for working in smaller areas.

Length	Width	Cut 0	Price	Cut 2	Price
6"	5/16"	311.381*	\$28.25	311.382*	\$29.95



Vul-Crylic

Double-end vulcanite file with open, coarse teeth for filing plastics, waxes and soft materials. One end is coarser than the other.

310.384 8" Overall Length \$10.50

311.385 7" Overall Length \$38.25



Warding Parallel in thickness and tapered in width. Useful for removal of burs. Length listed is working (cut) area.

Length	Width	Thickness	Cut 00	Price	Cut 0	Price	Cut 2	Price	Cut 4	Price
3"	23/64"	1/32"	—	—	311.387*	\$22.95	311.388*	\$24.75	—	—
4"	1/2"	3/64"	311.389*	\$22.25	311.390*	\$23.50	311.391*	\$25.25	311.392*	\$29.50
6"	5/8"	5/64"	311.393*	\$26.25	311.394*	\$27.50	311.395*	\$29.95	311.396*	\$34.75
8"	7/8"	7/64"	311.397*	\$35.95	311.398*	\$38.25	311.399*	\$41.25	—	—

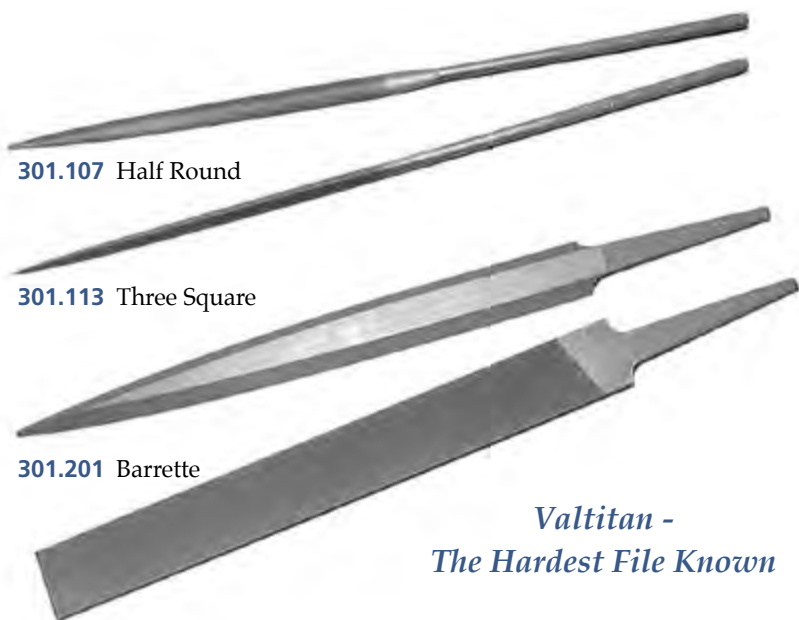

301.107 Half Round

301.113 Three Square

301.201 Barrette

301.211 Hand

*Valtitan -
The Hardest File Known*

Valtitan Yellow Tang Needle and Hand Files
For Platinum and Other Hard Metals

You can count on Valtitan files.

- Hardest file known - Rockwell hardness 72Hrc.
- Better performance on hard-to-file surfaces.
- Little or no clogging; a simple knock is enough to remove the chips.
- Resistant to corrosion.
- Longer life.

Needle Files

301.107	Half Round	\$25.00
301.113	Three Square	\$22.25

Hand Files

301.201V	Barrette	\$50.75
301.211V	Hand	\$36.25



330.905

330.904

330.910

310.690

330.870

Pocket Needle File Set

This file set includes 6 different shapes all cut 2, 4" files with handles shortened so they conveniently store in the handle. With a handy pocket clip and aluminum anodized handle, you can carry anywhere. Handle length is 5⁵/₈".

330.905 **\$17.50**

Mini Needle File Set

Mini files 4", cut 2 store in anodized handle. Includes six different shapes which are changed easily in the chuck. Features pocket clip and steel chuck. Handle measures 5/16" in diameter and 5⁵/₈" long and is well knurled for easy gripping.

330.904 **\$12.75**

Pocket Diamond Needle File Set

Pen sized aluminum holder/handle with 3/8" diameter, 5⁵/₈" long anodized barrel and pocket clip holds 4" diamond needle files with shortened shanks that are stored in the barrel. Handle has non-slip finger grip surface for positive control.

330.910 **\$20.95**

Lifetime File Handle

Our large needle file handle is 4¹/₂" long by 1/2" in diameter and fits 7³/₄" needle files. It features a steel "easy release" chuck, pressed into the handle for a firm hold. This handle will last a lifetime and makes filing much easier.

310.690 **\$8.50**

Swiss Pattern Needle File Set with Handle

Designed to meet the exacting requirements of instrument makers, jewelers, watchmakers and other craftspeople. Precision made in the USA of the finest quality tool steel. 5¹/₂" long knurled aluminum handle provides maximum control and comfort. Files are 8¹/₂" long. Includes flat, round and triangle files plus handle.

330.870 **\$9.95**

Rubber and Iron Bench Filing Block on page 125.

Grobet Swiss Needle Files

Precision files, for exacting work, especially under magnification. Made of the highest quality steel, machined and finished for precision shape, accuracy and balance. With round, knurled handles or plastic handles as noted. Length listed for Needle Files is Overall length.

● Length 4" has 1 3/4" cut portion ● Length 5 1/2" has 2 1/2" cut portion ● Length 6 1/4" has 3" cut portion ● Length 7 3/4" has 4 1/8" cut portion



Knurled Handle



Plastic Handle

Barrette

Length	KNURLED HANDLES										PLASTIC HANDLES					
	Cut 00	Price	Cut 0	Price	Cut 2	Price	Cut 4	Price	Cut 6	Price	Cut 0	Price	Cut 2	Price	Cut 4	Price
4"	—	—	311.450	\$15.25	311.451	\$15.25	—	—	—	—	301.450*	\$16.75	301.451*	\$16.75	—	—
5 1/2"	—	—	311.453*	\$12.50	311.454	\$12.50	311.456	\$12.95	—	—	301.453*	\$14.25	301.454*	\$14.25	301.456*	\$14.95
6 1/4"	311.458*	\$15.25	310.459*	\$14.25	310.461	\$14.25	310.463	\$14.95	311.464	\$18.75	301.459*	\$15.50	301.461*	\$15.50	301.463*	\$16.25
7 3/4"	—	—	311.466*	\$16.75	311.468	\$16.80	311.470	\$18.75	311.471*	\$37.50	—	—	—	—	—	—

Crossing

Length	KNURLED HANDLES										PLASTIC HANDLES					
	Cut 0	Price	Cut 2	Price	Cut 4	Price	Cut 6	Price	Cut 0	Price	Cut 2	Price	Cut 4	Price		
4"	311.484*	\$19.25	311.485*	\$19.25	—	—	—	—	301.484*	\$21.25	301.485*	\$20.95	—	—		
5 1/2"	311.487*	\$14.95	311.488	\$14.95	311.489*	\$15.95	—	—	301.487*	\$16.75	301.488*	\$16.75	301.489*	\$17.75		
6 1/4"	311.490*	\$15.75	311.491*	\$15.75	311.492	\$17.50	311.493*	\$20.65	301.490*	\$17.50	301.491*	\$17.50	301.492*	\$19.25		
7 3/4"	311.494*	\$19.50	311.495*	\$19.50	311.496*	\$21.75	—	—	—	—	—	—	—	—		

Equalling

Length	KNURLED HANDLES										PLASTIC HANDLES					
	Cut 00	Price	Cut 0	Price	Cut 2	Price	Cut 4	Price	Cut 6	Price	Cut 0	Price	Cut 2	Price	Cut 4	Price
4"	—	—	311.498*	\$13.50	311.499*	\$13.50	311.500*	\$14.95	—	—	301.498*	\$15.75	301.499*	\$15.75	—	—
5 1/2"	—	—	311.501*	\$11.25	311.502	\$11.25	311.503*	\$11.75	—	—	301.501*	\$12.95	301.502*	\$12.95	301.503*	\$13.50
6 1/4"	311.505*	\$12.25	311.506*	\$12.25	311.508	\$12.25	311.510	\$12.50	311.511*	\$16.75	301.506*	\$13.95	301.508*	\$13.95	301.510*	\$14.25
7 3/4"	—	—	311.512*	\$16.10	311.513	\$16.10	311.514*	\$16.75	—	—	—	—	—	—	—	—

Half-Round

Length	KNURLED HANDLES										PLASTIC HANDLES					
	Cut 00	Price	Cut 0	Price	Cut 2	Price	Cut 4	Price	Cut 6	Price	Cut 0	Price	Cut 2	Price	Cut 4	Price
4"	—	—	311.516*	\$18.25	311.517*	\$17.40	—	—	—	—	301.516*	\$20.00	301.517*	\$20.00	—	—
5 1/2"	—	—	311.519*	\$14.75	311.520*	\$14.75	311.522	\$15.95	—	—	301.519*	\$16.50	301.520*	\$16.50	301.522*	\$17.75
6 1/4"	311.524*	\$15.50	311.525	\$15.50	310.527	\$18.25	310.529	\$21.75	311.530*	\$21.75	301.525*	\$17.50	301.527*	\$17.50	301.529*	\$19.25
7 3/4"	—	—	311.531	\$19.50	311.533*	\$19.50	311.535*	\$21.75	—	—	—	—	—	—	—	—

Length	KNURLED HANDLES										Warding Length	KNURLED HANDLES	
	Cut 0	Price	Cut 2	Price	Cut 4	Price	Cut 6	Price	Cut 0	Price			
4"	311.537*	\$18.50	311.538*	\$18.50	311.539*	\$10.25	—	—	—	—	7 3/4"	311.668	\$16.75
5 1/2"	311.540*	\$14.50	311.541	\$14.10	311.542*	\$15.50	—	—	—	—	—	—	—
6 1/4"	311.543*	\$15.25	311.544*	\$15.25	311.545*	\$17.25	311.546*	\$21.25	—	—	—	—	—

Grobet Swiss Needle Files Length listed for Needle Files is Overall length.



Pillar Round Edge

KNURLED HANDLES

Length	Cut 0	Price	Cut 2	Price	Cut 4	Price
6 1/4"	311.547*	\$15.25	311.548*	\$15.25	311.549*	\$16.95



Knife

KNURLED HANDLES

Length	Cut 0	Price	Cut 2	Price	Cut 4	Price	Cut 6	Price
4"	311.551*	\$17.95	311.552*	\$17.95	—	—	—	—
5 1/2"	311.554*	\$14.25	311.555*	\$14.25	311.556*	\$15.50	—	—
6 1/4"	311.558*	\$15.25	311.559	\$15.25	311.561	\$16.95	311.562	\$21.25
7 3/4"	311.563*	\$18.75	311.564*	\$18.75	311.565*	\$21.25	—	—



Marking

KNURLED HANDLES

Length	Cut 0	Price	Cut 2	Price	Cut 4	Price	Cut 6	Price
4"	311.567*	\$18.50	311.568*	\$18.50	311.569*	\$17.50	—	—
5 1/2"	311.570*	\$14.50	311.571*	\$14.50	311.572*	\$15.50	—	—
6 1/4"	311.573*	\$15.25	311.574*	\$15.00	311.575*	\$16.95	311.576*	\$21.25



Round

KNURLED HANDLES

PLASTIC HANDLES

Length	Cut 00	Price	Cut 0	Price	Cut 2	Price	Cut 4	Price	Cut 6	Price	Cut 0	Price	Cut 2	Price	Cut 4	Price
4"	—	—	311.582*	\$13.55	311.583*	\$13.55	311.584	\$16.30	—	—	301.582*	\$16.25	301.583*	\$16.25	—	—
5 1/2"	—	—	311.585*	\$11.10	311.586	\$11.30	311.588*	\$12.50	—	—	301.585*	\$13.25	301.586*	\$13.50	301.588*	\$14.25
6 1/4"	311.590*	\$13.75	311.591*	\$12.25	310.593*	\$12.95	310.595*	\$16.75	311.596*	\$16.75	301.591*	\$13.95	301.593*	\$13.95	301.595*	\$15.25
7 3/4"	—	—	311.597*	\$14.75	311.598*	\$14.75	311.599*	\$16.50	—	—	—	—	—	—	—	—



Slitting

KNURLED HANDLES

PLASTIC HANDLES

Length	Cut 0	Price	Cut 2	Price	Cut 4	Price	Cut 6	Price	Cut 0	Price	Cut 2	Price	Cut 4	Price
4"	311.601*	\$18.25	311.602*	\$18.25	—	—	—	—	301.601*	\$17.25	—	—	—	—
5 1/2"	311.604*	\$14.25	311.605*	\$14.25	311.606*	\$15.50	—	—	301.604*	\$16.25	301.605*	\$16.25	301.606*	\$17.25
6 1/4"	311.607*	\$15.75	311.608*	\$15.25	311.609*	\$16.95	311.610*	\$21.25	301.607*	\$14.75	301.608*	\$14.75	301.609*	\$10.25



Square

KNURLED HANDLES

PLASTIC HANDLES

Length	Cut 00	Price	Cut 0	Price	Cut 2	Price	Cut 4	Price	Cut 6	Price	Cut 0	Price	Cut 2	Price	Cut 4	Price
4"	—	—	311.612*	\$15.50	311.613*	\$15.50	—	—	—	—	301.612*	\$17.25	301.613*	\$17.25	—	—
5 1/2"	—	—	311.615*	\$12.95	311.616*	\$12.95	311.617*	\$13.95	—	—	301.615*	\$14.75	301.616*	\$14.75	301.617*	\$15.75
6 1/4"	311.619*	\$13.75	311.620	\$13.75	311.622	\$13.75	311.624	\$15.25	311.625*	\$18.75	301.620*	\$11.75	301.622*	\$15.50	301.624*	\$16.75
7 3/4"	—	—	311.626*	\$16.75	311.627*	\$16.75	311.628*	\$18.75	—	—	—	—	—	—	—	—



Three Square

KNURLED HANDLES

Length	Cut 00	Price	Cut 0	Price	Cut 2	Price	Cut 4	Price	Cut 6	Price
4"	—	—	311.630*	\$15.95	311.631*	\$15.95	—	—	—	—
5 1/2"	—	—	311.633	\$12.95	311.634*	\$12.95	311.636*	\$13.95	—	—
6 1/4"	311.637*	\$13.95	311.638*	\$13.75	311.640	\$13.75	311.642*	\$15.25	311.643*	\$18.75
7 3/4"	—	—	311.645	\$16.75	311.647*	\$16.75	311.649*	\$18.75	311.650*	\$65.00

Grobet Swiss Escapement Files

Also known as square handled needle files, these precision files are available in Barrette shape. Overall length is 5½", length of cut is 1¼" to 2⅞" depending upon shape. Swiss made Vallorbe.

311.700	Barrette	Cut 0	\$22.25
311.701	Barrette	Cut 2	\$22.25
311.703	Barrette	Cut 4	\$23.75
311.704	Barrette	Cut 6	\$28.25



311.700
311.701
311.703
311.704

Set of Six Mascot® Utility Files with Handles

This handy utility set consists of six American Pattern file shapes: square, half-round, three-square, round, flat and warding. Files have approximately a 4" length of cut with an overall length of 7". Each file has a smooth wooden handle. Set comes in a hanging pouch.

321.510 **\$22.50**

321.510

TELL SWISS™ Wax File Set

Excellent for shaping waxes and other materials, such as wood and plastic. Wide-tooth style does not clog as easily as conventional file. Overall length 5½". Six different shapes in a plastic pouch.

331.922 **\$82.95**



331.922

Set of Six Wax Files

Excellent for shaping wax, wood or plastic. Overall length 6". Wide tooth style does not clog as easily as regular style files. India.

330.923 **\$5.25**

330.923

Wax File Set

Set of 3 EuroPoint files with non-roll handles.

330.924 **\$13.25**



330.924

More wax carving tools on pages 290, 301.



331.906



331.867



310.004

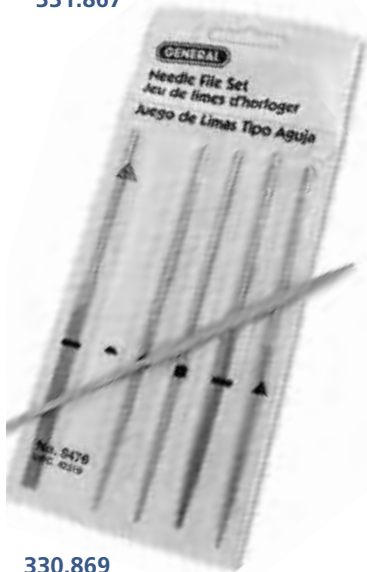

330.869

TELL™ SWISS Needle File Sets

Well-made, yet economical, Swiss needle files are made of chrome alloy steel. Overall length is 5 1/2", with cut portion 3". Assorted shapes in a plastic pouch.

Cut	Set of 6	Price	Set of 12	Price
Med	331.906	\$28.50	331.908*	\$57.25
Fine	331.907	\$32.25	331.909*	\$63.75

Mascot® Needle Files

Swiss-made, single-cut files do not clog as easily as double-cut. Overall length 5 1/2". Smooth cut only.

No.	Shape	Price
331.860*	Equalling	\$5.75
331.861*	Flat	\$5.75
331.862*	Half-Round	\$7.75
331.863*	Round	\$5.75
331.864*	Square	\$6.50
331.865*	Three-Square	\$5.95

Set of Six Mascot® Needle Files

Contains equalling, flat, half-round, round, square, and three-square styles in a pouch.

331.867 **\$41.25**

Set of Six Swiss Needle Files

For metal, wood, plastics and rubber. Set includes six high-quality tool steel files: two Flat and one each Round, Half-Round, Square and Triangle. 5 1/2" overall length. Made in Switzerland.

330.869 **\$26.50**

Needle File Set

Set of 12 different shaped files. Medium cut. Swiss made.

310.004 **\$10.95**

Call or fax by 3:00PM
Your Local Time
(Mon-Thurs)
for Overnight Delivery
1-800-487-0408 P
1-800-487-5848 F

Did you know?
You can
FAX
your order!
1-800-487-5848

Questions
about your order?
Call us!
We're ready to help.
1-800-487-0408

Diamond Needle Files

Engineered to deliver performance unequaled by any other file, for use on ultra-hard materials. Carbide, hardened steel, exotic metals, ceramics, and glass are no match for these precision files. Excellent material removal is the result of a unique process which bonds the 2 1/2" long diamond surface. Available in fine grit Mascot® Brand or coarse grit Grobet USA™ Brand. Sets of 5 contain one each of equalling, half-round, round, square and three-square. Overall length 5 1/2".

	Fine Grit	Price	Coarse Grit	Price
Barrette	331.958*	\$17.95	331.980*	\$25.50
Crossing	331.959*	\$17.95	331.984*	\$25.50
Equalling	331.961*	\$17.95	331.971*	\$25.50
Half-Round	331.962*	\$17.95	331.972*	\$25.50
Round	331.963*	\$17.95	331.973*	\$25.50
Square	331.964*	\$17.95	331.974*	\$25.50
Three-Square	331.965*	\$17.95	331.975*	\$25.50
Crochet	331.966*	\$19.25	331.976*	\$25.50
Warding	331.967*	\$19.25	331.977*	\$25.50
Knife	331.968*	\$27.95	331.978*	\$28.95
Pippin	331.969*	\$18.50	—	—
Set of 5	331.960	\$88.95	331.970*	\$127.95

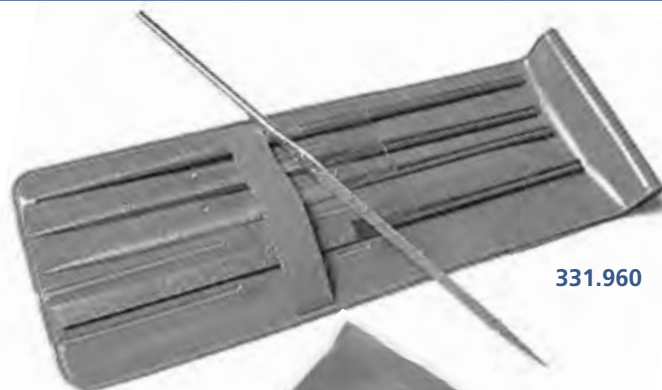

331.960



310.003

Diamond Needle File Set

Set of 10 different shaped files, each measures 4" long. Diamond surface is excellent for deburring, smoothing and finishing ultra-hard metals. In plastic pouch.

310.003 **\$14.25**

Large Diamond File Set

Hard to find larger diamond files come in a five-piece set. Each file measures 180mm (7") x 5mm with a diamond cut length of 80mm and a comfortable plastic grip handle. Set includes one each Half-Round, Three Square, Flat, Round and Crossing.

310.000 **\$31.50**



310.000

Economy Half-Round File

Made in Switzerland with a built in handle. Overall 6", cut 0.

331.814* **\$21.75**

Vallorbe® Universal Pivot File/Burnisher

Universal Vallorbe® burnishers are polished and have slightly rounded corners. Double ended left or right style, 6 x 3mm x 180mm (7 1/8") long. Swiss made.

311.01710  Right Vallorbe LP3212 **\$65.95**

311.01720  Left Vallorbe LP3211 **\$65.95**



331.814*

311.01710
311.01720



371.8115



371.781 -
371.787



310.690



371.791 -
371.796



371.801 -
371.804

371.832 -
371.837



370.820



330.981



371.822

331.979*

Vallorbe® Rubber File Handle

Ergonomically designed to fit the hand for comfort and non-slip grip. For 4" - 6" files. Swiss made.

371.8115

\$4.75

Plastic File Handles for Swiss Precision Files

Unbreakable plastic with non-slip grip. Provides working comfort over long periods. Tang-gripping insert has two threaded sections of different diameters to assure proper alignment and positive hold. For Swiss precision files with tangs.

No.	Handle Size	Price	No.	Handle Size	Price
371.781*	1	\$5.60	371.785	5	\$5.60
371.782*	2	\$5.60	371.786*	6	\$5.55
371.783	3	\$5.60	371.787*	7	\$5.85
371.784	4	\$5.60			

Wood File Handles with Wire Ferrules

Natural finish. Wound wire ferrule provides extra strength to prevent splitting. Handles fit files 2" to 20" in length.

No.	File Length	Price	No.	File Length	Price
371.791	2" - 4"	\$2.40	371.794*	10" - 14"	\$3.00
371.792*	4" - 6"	\$2.40	371.795*	14" - 16"	\$3.60
371.793	6" - 10"	\$2.75	371.796*	16" - 20"	\$3.75

Hardwood File Handles

Handles have metal ferrules suitable for small files, gravers.

No.	Length	Diam	Price	No.	Length	Diam	Price
371.832	3"	7/16"	\$2.75	371.836*	4"	5/8"	\$2.75
371.833*	4"	3/8"	\$2.75	371.837*	4"	3/4"	\$2.75
371.834*	4"	1/2"	\$2.75				

Lifetime File Handle

Our large needle file handle is 4 1/2" long by 1/2" in diameter and fits 7 3/4" needle files. It features a steel "easy release" chuck, pressed into the handle for a firm hold. This handle will last a lifetime and makes filing much easier.

310.690

\$8.50

Force-Fit Wood File Handles

Sturdy, force-fit type of handle.

No.	File Length	Price	No.	File Length	Price
371.801	3" - 6"	\$4.20	371.803*	8" - 12"	\$5.60
371.802	6" - 8"	\$4.20	371.804*	14" - 16"	\$6.10

SKROO-ZON Handle

Steel die inside wood handle cuts its own thread on file tang. For 6" files.

370.820

\$3.25

File/Burnisher Hardwood Handle

Handle with metal ferrule. Overall length 3 3/4", 1/2" diameter.

371.822

\$3.50

File Cleaners

Steel wire bristles mounted on handle for removing particles clogging teeth of file. 10" long.

330.981 Wood Handle

\$9.50

331.979* Wood handle with brush on reverse side

\$12.65

File Handle Selection

File Length	4"	6"	8"	10"	12"	14"
File Shape	Recommended Handle					
Barrette	3	4	5	-	-	-
Checkering	-	4	-	-	-	-
Crochet	3	4	5	-	-	-
Crossing	2	4	5	-	-	-
Equalling	2	3	4	-	-	-
Half-Round	3	4	5	6	-	-
Hand	3	4	5	6	7	-
Knife	3	4	5	6	7	7
Pillar	3	4	4	6	6	-
Pippin	3	4	5	-	-	-
Round	1	3	4	5	-	-
Rnd Parallel 3/16", 1/4"	-	2	3	-	-	-
1/8", 5/32", 3/8"	1	1	-	-	-	-
Slitting	2	4	-	-	-	-
Square	2	3	4	5	6	-
3-Square	2	4	4	5	6	-
Warding	2	4	5	6	7	-

Rawhide Mallets

Rawhide mallet heads are compressed under hydraulic pressure, then seasoned for durability. They deliver firm, non-marring blows from a large striking face, and are ideal for working on sheet metal, copper, brass and other soft metals. Top quality hardwood handles. Made in England.

Number	Face	Length	List	Our Price
370.700	1"	2 ¹ / ₈ "	\$17.75	\$14.95
370.701	1 ¹ / ₄ "	2 ³ / ₄ "	20.00	\$17.75
370.702	1 ¹ / ₂ "	3"	23.65	\$21.50
370.703	1 ³ / ₄ "	3 ¹ / ₈ "	29.55	\$24.95
370.704	2"	3 ¹ / ₄ "	34.65	\$29.25



370.700 - 370.704

Boxwood Mallet

Made of the finest quality boxwood, one of the hardest woods available. Mounted on seasoned wood handle. Excellent for removing dents and straightening and flattening metals. Head is 2³/₈" long, face is 1³/₈" in diameter.

371.0183 **\$10.30**



371.0183

Plastic Mallets Won't Mar Metals

For metalworking where work cannot be marred. Plastic cushions the shock at impact, yet the "bounce back" is about the same as rawhide. The plastic head can be refaced by filing and sanding. The face diameter of the head is 1³/₈" and the length is 3¹/₂".

371.646 **\$20.50**



371.646

Jeweler's Hammer with non-marring polymer heads

Lightweight wear-resistant polymer heads are more durable than nylon. Non-marring properties make it perfect for precious metal work. Solid metal head base is securely screwed to the hardwood handle. 9¹/₂" long overall, 3/4" diameter heads.

370.529 **\$11.95**



370.529

Mallets with Detachable Faces

Faces can be changed to provide any combination desired and can be replaced when worn. Supplied with two different faces and wrench to tighten or remove collars.

370.534	Brass/Fiber	2 ¹ / ₂ oz	9/16" x 2"	\$14.95
370.536	Brass/Nylon	2 ¹ / ₂ oz	9/16" x 2"	\$15.45
370.582	Brass/Fiber	5 oz	5/8" x 2 ⁵ / ₈ "	\$19.25
370.584	Brass/Nylon	5 oz	5/8" x 2 ⁵ / ₈ "	\$20.25

Replacement Faces

Face	13mm Diam. for 2 ¹ / ₂ oz		15mm Diam. for 5 oz	
	Price	Price	Price	Price
Brass	371.550	\$2.40	371.590	\$2.40
Fiber	371.551	\$2.40	371.591	\$2.40
Nylon	371.552	\$2.40	371.592	\$2.40
Collars for 2 ¹ / ₂ oz.	371.553	\$2.15		



370.534
370.582
370.584

Brass and Fiber Mallet

Solid brass head is 2" long with one fiber end.

371.0181 **\$12.90**



371.0181



371.172 - 371.178*



370.184
371.0365
371.0366*
371.0367*



371.0410



370.200



371.122
371.124



371.110
371.112
371.114*
371.118*



371.0409

Master Quality Chaser's Hammers with Round Handles

The large flat surface is used to flatten objects and to strike chasing tools. Round end is for riveting and making decorative designs on metals. Forged steel heads mounted on round hardwood handles.

Round Handles	Face Diameter	Price
371.172*	7/8"	\$45.25
371.174*	1"	\$74.90
371.176*	1 1/8"	\$75.90
371.178*	1 1/4"	\$82.70

Economical Chaser's Hammers

Designed for silversmiths and for arts and crafts work. Flat head is used to flatten, shape and form objects and to strike chasing tools. Round end is for forming decorative patterns and designs. Complete with hardwood handles.

370.184	Round	1"	\$12.10
371.0365	Pistol	1"	\$14.95
371.0366*		1 1/8"	\$17.45
371.0367*		1 1/4"	\$19.75

Handles for Chaser's Hammers

Overall length 10".

371.0410	Pistol	\$7.30
371.0411*	Round	\$7.75
371.0412*	Oval	\$7.75

Jeweler's Hammer has a ball and three flat heads

One end has a 1/2" diameter steel ball. The other has interchangeable nylon, brass and copper flat heads, 1" diameter for forming a variety of metals. Hardwood handle.

370.200	\$19.95
---------	---------

Master Quality Ball Pein Hammers

High carbon steel heads provide extra strength for driving chisels, punches, etc.

No.	Head Length	Head Weight	Price
371.122*	2"	2 oz	\$32.05
371.124	2 3/4"	4 oz	\$34.65

Economical Quality Ball Pein Hammers

General use with one flat, one round end, and hardwood handles.

No.	Head Length	Head Weight	Price
371.110	1 7/8"	1 oz	\$8.50
371.112	2"	2 oz	\$7.45
371.114*	2 5/8"	4 oz	\$7.70
371.118*	3 1/4"	8 oz	\$8.70

Goldsmith's Hammer

Head is 3 1/2" long with one round flat end, 5/8" diameter and one chisel-shaped end. Sturdy hardwood handle. 11 7/8" overall length with 4 oz. head weight.

371.0409	\$47.05
----------	---------

BERGEON Watchmaker's Hammer

Chromium plated steel head on wooden handle. 9¹/₄" long.

640.1438.C3 **\$29.95**

Swiss-Style Hammers

Ideal for watchmakers or other light work. One end is flat and the other is chisel-shaped for spreading rivets. Forged heads are mounted on hardwood handles.

No.	Head Length	Price
371.240	2 ¹ / ₄ "	\$9.50
371.242	2 ¹ / ₂ "	\$10.30
371.244	2 ³ / ₄ "	\$11.10
371.246	3"	\$11.30

Riveting Hammers

General use, with one end flat and the other chisel-shaped for spreading rivet heads. Drop forged, polished head is mounted on select hardwood handle. No.371.212 is economy quality.

No.	Face Diameter	Head Stamped	Head Length	Head Weight	Price
371.212	5/16"	-	3"	2 oz	\$7.20
371.216	1/2"	0	3 ⁵ / ₈ "	4 oz	\$49.95
371.218*	1/2"	1	4"	5 oz	\$46.95
371.220*	5/8"	2	4 ¹ / ₄ "	7 oz	\$72.95

BERGEON Watchmaker's Brass Hammer

Brass head with flat and curved ends on wooden handle. 9" long.

640.30416 **\$31.50**

Flat/Ball Pein Brass Hammer

This 2oz hammer features a superb quality solid brass head threaded onto an anodized aluminum handle. A special compound is used to assure the head cannot release. The handle is hex shape to prevent slipping.

370.533 **\$14.95**

Brass Hammer for Surface Protection

For watchmakers and other craftsmen when surface protection is essential. Solid brass head measures 2" x 5/8" with one round and one flat end on wood handle. 9¹/₂" long. India.

370.530 **\$6.55**

Nylon Double Faced Hammer

A handy, versatile hammer offering the best in quality and value. Will not mar or leave a mark on your work. 7/8" easy screw-off faces are simple to replace. Chrome plated base with comfortable rubber grip plastic handle. Grobet.

371.710 **\$12.95**



640.1438.C3



371.240 - 371.246



371.212 - 371.220*



640.30416



370.533



370.530



371.710



460.063

The Whammer™ by Beadsmith®

Designed by Linda Jones, the Whammer is a must-have tool for every jeweler! Created for use on wire, silversmiths will also love this compact tool.

- Features a fixed convex steel head plus interchangeable nylon flat head and steel dapping head - 3 tools in 1!
- Short ergo handle enables a perfect grip and improved striking accuracy.
- Extra weight in the head reduces the striking power needed to achieve great results.

460.063

\$20.95



370.880

Jeweler's Hammer with 12 Interchangeable Heads

This 12 ounce hammer from Beadsmith includes six smooth inserts; flat and domed in nylon, stainless steel and brass, plus six textured head inserts in stainless steel; stripes, weave, speckles, dots, thin circles and wide circles. Heads easily screw on and off. 9½" long with comfortable ergonomic grip.

370.880

\$41.95



371.0362

Utility Riveting Hammer

General utility hammer with chisel formed end for spreading rivets and metal handle. Overall length 9", head length 2¹³/₁₆".

371.0362

\$9.00



370.890

Hammer Features Nine Textures in One

The patterns are endless! Use the small designs to pinpoint texture in a certain area, the large designs to cover a bigger area or use multiple tips to layer textures on one another. Each 3/4" tip is easily and securely attached with a threaded collar. Head weight 8oz., overall length 9½".

370.890

\$38.95

Anvils & Blocks, pages 125 - 126.

Please order items
by SKU number.

Heavy Duty Bench Knife

Blade is firmly set in hardwood handle. Available in two lengths.

390.105* 5 ³ / ₄ " Long, 1 ³ / ₄ " Blade	\$27.75
391.110* 6 ⁵ / ₈ " Long, 2 ⁵ / ₈ " Blade	\$19.25

Sloyd Bench Knife

Heavy-duty bench knife with thick steel blade securely mounted in heavy hardwood handle. 5¹/₂" long, blade 1⁵/₈".

391.0626	\$5.90
-----------------	---------------

Extra Sharp Bench Knife

Steel blade in a comfortable hardwood handle. 5³/₄" long.

590.043	\$3.25
----------------	---------------

All-Purpose Bench Knife

Sharp, well-tempered blade firmly mounted in hardwood handle. 5" long, blade length 1³/₄".

391.104	\$7.25
----------------	---------------

Medium Duty Bench Knife

Has slim 1³/₄" blade set firmly in hardwood handle. 5" long.

391.180	\$18.95
----------------	----------------

Solid Scraper

Ideal for cleaning, smoothing and deburring metals and plastics. Prepare surfaces for soldering, remove excess solders, open bezels, etc. Sharp from handle to tip and can be resharpened on a bench stone. Securely mounted in hardwood handle. 3" blade.

521.200*	\$24.50
-----------------	----------------

Economy Scraper

Wood handle with 2¹/₂" hollow straight blade.

521.101	\$14.05
----------------	----------------

Lightweight Knife with 3 Blades

Exceptionally sharp blades for cutting patterns, as well as many other uses. Comes with one #16 and two #11 blades.

391.250	\$8.75
391.253 Blades Style #11	\$3.25/5 pack
391.254 Blades Style #16	\$4.95/5 pack



Case Opener Knives, pages 77 - 79

Three ways to order:

- 1) Call 1-800-487-0408
- 2) Fax to 1-800-487-5848
- 3) Online at www.casker.com



491.750
491.753
491.754



491.700 -
491.708



491.720

Sawframes with End Screws

Made in Germany. Equipped with tension screw for drawing blades taut. Otherwise, same construction as standard frames.

No.	Depth	Price
491.750	2 1/2"	\$22.25
491.753	3"	\$19.95
491.754	4"	\$26.00

Standard Jewelers' Sawframes

Made in Germany. For piercing, flat and spiral sawblades. Serrated clamps hold blades firmly. Strongly constructed flat steel frames, hardwood handles and thumb screw locking devices. Most common depth is 2 1/4", others for use when greater cutting depth is required.

No.	Depth	Price
491.700	2 1/4"	\$16.75
491.703	3"	\$17.95
491.704	4"	\$20.25
491.705	5"	\$21.60
491.706	6"	\$24.95
491.708*	8"	\$29.00

Ergonomic Frames let you saw longer with less fatigue

Two lightweight, perfectly balanced sawframes with ergonomic handles reduce fatigue and provide greater dexterity. Patented blade-lock design eases blade insertion, maintains perfect alignment and eliminates wobble. Precision-made in Switzerland of the highest quality spring steel with non-glare finish. Set screws can be used on either the left or right side of the frame. 2 3/4" deep.

491.720	Adjustable (shown)	\$20.25
491.722*	Fixed	\$20.25



490.799

3-Piece Miniature Saw Frame Set

Perfect for getting into confined areas, this set of mini saw frames give precision control for delicate jobs such as preparing mountings for stone-setting, working around prongs, and adding fine touches to wax carvings or scrolls. 2-3/4" non-adjustable opening holds standard jeweler's saw blades.

490.799 **\$34.95**



130.340

Piercer's Pleasure

For holding metal, wood or plastic for easy sawing. Break fewer blades. Less hand fatigue. Hardwood. Fits standard bench slot or clamps to table. Powerful spring and non-slip jaws grip metal gauges 32 to 4.

130.340 **\$17.75**



190.928

Bur & Blade Lubricant

Keeps burs, drills, sawblades and gravers working smoother and longer. Reduces heat and friction to speed the cut. Push-up tube.

191.928 **\$5.25**



491.890
491.891

Circular Saws

For miniature work. Made of .004" (0.10mm) thin stainless steel. With 1/16" diameter center holes for mandrel mounting. In dozens.

No.	Diam.	Teeth per inch	Dozen
491.890	3/4"	42	\$40.75
491.891	7/8"	45	\$38.70

Jeweler's Sawblade Sizes

Sizes in millimeters. Teeth per inch.

Size	Thick.	Width	Teeth/in.	Size	Thick.	Width	Teeth/in.
8/0	0.15	0.33	84	1	0.30	0.64	47
7/0	0.18	0.36	84	2	0.33	0.69	44
6/0	0.18	0.36	76	3	0.36	0.74	40
5/0	0.20	0.41	66	4	0.38	0.79	37
4/0	0.23	0.43	64	5	0.41	0.84	35
3/0	0.25	0.48	57	6	0.43	0.94	33
2/0	0.25	0.53	53	8	0.51	1.14	28
1/0	0.28	0.58	51	10	0.61	1.35	24
				12	0.61	1.65	20

Superior Quality, Accurate Cutting at Low Prices!



Pike Platinum Jewelers' Sawblades
Specially developed to offer incomparable resistance to wear when cutting platinum, stainless steel and all hard metals. They will improve your sawing comfort while allowing clean, precise cuts with minimum effort. Made from a special high-quality steel. Filed teeth guarantee cutting capacity unequalled by any other process. Available in Nos.4/0, 3/0 and 2/0 with round backs. Swiss made.

No.	Size	Dozen	Per Doz
491.475	4/0	\$4.45	\$3.25
491.476	3/0	\$4.45	\$3.25
491.477	2/0	\$4.45	\$3.25

Gold Shark™ Sawblades

Superior quality in specially hardened, selected steel piercing sawblades. The finest value blades accepted and appreciated by jewelers worldwide. The teeth are uniformly honed to ensure the most accurate and rapid cut. Round back to facilitate cutting of curves. Available in cuts fine to coarse. Length 130mm. Made in Switzerland.

Number	Cut	144
490.130	6/0	\$37.95
490.131	5/0	\$38.25
490.132	4/0	\$31.95
490.133	3/0	\$29.95
490.134	2/0	\$29.95
490.135	0	\$29.95
490.136	1	\$29.95
490.137	2	\$29.95
490.138	3	\$29.95
490.139	4	\$29.95
490.140	5	\$30.95



Herkules® "White Label"

For cutting all metals, bone, pearl and other hard materials. Round backs make it easy to turn corners and follow curves, operations that may break other saws. Minimum one dozen of a number.

No.	Size	Dozen	Per Doz
491.100	8/0	\$5.75	\$4.15
491.101	7/0	\$4.85	\$3.90
491.102	6/0	\$4.10	\$3.25
491.103	5/0	\$3.95	\$3.10
491.104	4/0	\$3.75	\$2.90
491.105	3/0	\$3.35	\$2.65
491.106	2/0	\$3.35	\$2.65
491.107	1/0	\$3.35	\$2.65
491.108	1	\$3.35	\$2.65
491.109	1 1/2	\$3.35	\$2.65
491.110	2	\$3.35	\$2.65
491.111	3	\$3.35	\$2.65
491.112	4	\$3.35	\$2.65
491.113	5	\$3.75	\$2.90
491.114	6	\$3.95	\$3.10
491.115	7	\$4.50	\$3.60
491.116	8	\$4.90	\$3.95
491.118	10	\$5.15	\$4.10
491.120	12	\$6.35	\$5.00
491.122	14	\$7.00	\$5.70



Skip-A-Tooth Sawblades

These blades are designed for wax cutting. Every other tooth is missing which provides smooth cutting and non-loading action. Size #1. Sold by the dozen.

491.320 \$3.75

Overnight Delivery ~
Monday-Thursday Call by
3:00PM Your Local Time
Friday call by 3:00PM Eastern

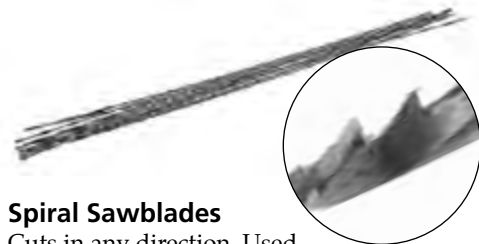

Spiral Sawblades

Cuts in any direction. Used for cutting rubber, plastics, wax, plaster and similar materials. Sold by the dozen.

No.	Size	Diameter (mm)	Dozen
491.300	1/0	0.56	\$4.60
491.301	1	0.61	\$4.60
491.302	2	0.70	\$4.60
491.303	3	0.74	\$4.60
491.304	4	0.78	\$4.60
491.305	5	0.84	\$4.60
491.306	6	0.91	\$4.60



Cas-Ker Economy Blades

Economy sawblades for jewelers and anyone requiring fine precision cutting. Made in India. Minimum 144 per size.

No.	Size	Dozen
490.001	3/0	\$5.50
490.002	4/0	\$5.50
490.003	2/0	\$5.50
490.004	1/0	\$5.50



BERGEON

Super Old Gold Label

Blades have rounded backs for all metals. 130mm. Minimum one dozen of a number.

Number	Bergeon Size	Doz	Per Dz
490.430	6651-A 6/0	\$4.30	\$3.60
490.431	6651-C 4/0	\$4.40	\$3.25
490.434	6651-D 3/0	\$3.50	\$2.90
490.432	6651-E 2/0	\$4.65	\$3.75
490.433	6651-F 0	\$4.70	\$3.20
490.438	6651-G 1	\$4.00	\$3.40



130.325

Combination Bench Pin & Anvil

Cast anvil, clamp opens to 2". Hardwood pin measures 4" x 1⁵/₈". Made in India.

130.325	\$19.95
131.327 Extra Bench Pin	\$3.50



130.361

V-Slot Pin

Support for filing, sawing and drilling. Clamps to any surface up to 2" thick. 7¹/₂" x 2¹/₂".

130.361 Pin w/Clamp	\$7.40
131.362* Extra Board	\$4.50



130.320

Wood Pin & Holder

Easily screws to edge of work bench. Thumb screw locks in replaceable pin.

130.320	\$8.95
----------------	---------------



131.0202

Wood Pins

130.300 5 ¹ / ₄ " x 2 ¹ / ₄ "	\$4.25
130.301 6 ¹ / ₄ " x 2 ³ / ₈ "	\$4.25



130.340

Bench Pin for Ring Clamp

Hole fits hard ring clamp #481.130.

131.0202	\$5.60
-----------------	---------------



130.391

Piercer's Pleasure

Secures metal, wood or plastic for easy sawing. Break fewer blades, with less hand fatigue. Fits standard bench slot or clamps to table. Powerful spring and non-slip jaws grip metal gauges 32 to 4. Left handed model available. Hardwood.

130.340	\$17.75
----------------	----------------

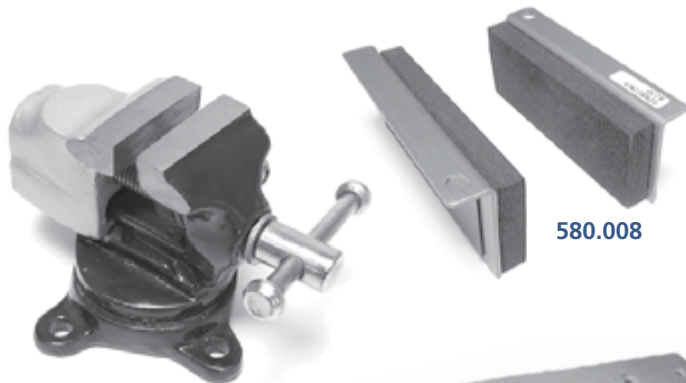

580.002

StudioFlux® Bench Pin

Use on top of your workbench for a flat, continuous surface for good sawing.

130.391	\$18.95
----------------	----------------

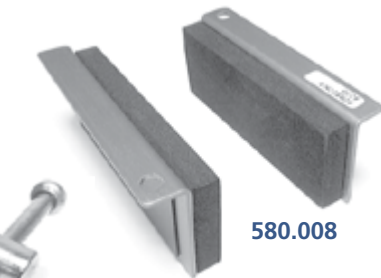

580.008

Bench Vise Pads

Magnetic strips hold Soff Jaws™ to your bench vise. Cushioned vinyl pads grip odd or round shapes or threaded parts, and prevent marring of finished surfaces. Soff Jaws are 3¹/₂" wide and fit best on 3", 3¹/₂" and 4" wide vises, but can be mounted on larger vises.

580.008	\$10.95
----------------	----------------

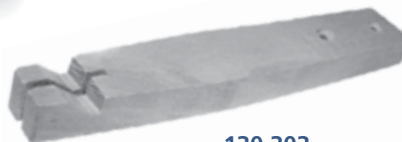

130.303

Small Rotating Vise for Delicate Work

Convenient vise with 1¹/₄" wide jaws. Nice gray finish. Drop-forged, smooth jaws for delicate work on soft metals.

580.002	\$16.50
----------------	----------------



480.110

Wood Pin for Rings

Screws to bench top and is shaped to hold rings. Slot for saw blade. 5¹/₂" x 1¹/₂" x 3³/₈".

130.303	\$3.50 ea	6 @ \$2.50 ea	12 @ \$2.00 ea
----------------	------------------	----------------------	-----------------------

Ring Holder for inside ring buffing

Eliminates dirty burnt fingers. Wood clamp holds rings securely to prevent accidents. India.

480.110	\$1.95 ea	3 @ \$3.50 ea
----------------	------------------	----------------------

Bench Vise

Economical, sturdy bench vise. Jaws are 1⁵/₈" wide and smooth. Clamps to any bench. Enamel finish. India.

580.001 **\$9.95**



580.001

Mini Bench Vise

Well made and strong with rust-proof finish. Double steel guide bars. Jaws are 1" wide and open to 1". Fits benches up to 1¹/₈" thick.

581.0519 **\$26.25**



581.0519

Standard Vise

3" wide smooth jaws that open to 2¹/₂". Built-in anvil.

581.101 **\$64.80**



581.101

Swivel Vise (not shown)

Position in any direction and lock. Guide rods assure parallel operation and rigidity. Smooth 2¹/₂" wide jaws. Anvil on top. Fits benches 2" thick.

581.104* **\$79.85**



581.104*

Case Holder clamps to your bench

Clamps on to the edge of your bench. The holder is made of metal and adjusts to hold any size watch case. Double shafts. India.

590.201 **\$6.50**

Lowell Pattern Hand Vise

Grooved corrugated jaws open and close by turning handle. Hollow handle holds long wire pieces not possible with regular hand vise. Jaws 1¹/₂" wide, 4³/₄" overall.

581.0528 **\$32.10**



581.0528

Wood Handled Hand Vise

A lightweight vise mounted in wood handle. Smooth jaws are 1¹/₄" wide and open to 1". Overall length is 6¹/₄".

581.130 **\$15.50**



581.130

Hand Vise

This vise holds small items for a variety of operations. Smooth spring action jaws open and close with wing nut. Comfortable hardwood handle. 6" long overall, jaw opens to 1¹/₈".

580.135 **\$31.50**



581.140*
581.141

Hand Vises

Serrated, grooved, spring action jaws, open and close with large wing nut. Handles are hollow so that long wire will pass through. Both jaw open to 1¹/₄". 4¹/₂" long.

581.140* Jaws 1¹/₄" **\$39.75**

581.141 Jaws 5¹/₈" **\$42.00**



580.135

Steel Hand Vise

Spring action in handle keeps jaws open. 1¹/₄" Jaws open to 7¹/₁₆". Jaws are serrated. Overall length 3³/₄".

581.120 **\$47.25**



581.120

BERGEON



640.7013.4

Genuine BERGEON Dip Oilers

High precision stainless steel needles, electropolished. Ergonomic, antistatic handle with colored rings for identification and perfect grip. Specially adapted for all precision oiling. Swiss made. Bergeon 7013. Sizes in mm.

640.7013N Black	0.18	640.7013V Green	0.32
640.7013R Red	0.18	640.7013J Yellow	0.45
640.7013B Blue	0.24		
Above Oilers			\$32.50 each

Set of 4 Oilers - Red, Blue, Green, Yellow

640.7013.4 **\$124.95**

Genuine BERGEON Automatic Oilers

Model 1A for oiling cap jewels, shock-absorbing devices without removal and small movement oiling. Needle measures 0.1475mm.

640.2718 **\$83.95**

Model 2A is for oiling pallet stones, chronographs, calendar movements, pin lever escapements and for use whenever a given quantity of oil is required. Needle measures 0.16mm.

640.2719 **\$86.95**

Model 5 - The end part of oiler is specially designed to fit exactly the space between the pivot and the rim of the jewel oil cup. Special hard needle measures 0.145 mm.

640.2720 **\$86.95**

Oiler Replacement Parts

Needle	Price	Plex well w/ tip	Price
640.2718P 7718-P	\$21.95	640.2718DR	\$28.95
640.2719P 7719-P	\$23.95	640.2719DR	\$26.95
640.2720P 7720-P	\$21.95		
640.4743/P*	\$8.50	640.4743/DR*	\$15.50
640.4744/P*	\$8.50	640.4744/DR*	\$15.50



640.2718



640.4722

Oiler for Watches

Pocket size lubrityl oiler for watches. Recommended for watchmaking, microtechnology and electronics. Reusable, with no waste - surplus oil returns back to the tank. Visible oil level. Hand: 0.90mm Length: 6". Comes with 2 packets of oil.

640.4722 **\$39.95**

BERGEON Set of 3 Automatic Oilers with Stand

These oilers will carefully deposit the precise amount of oil everywhere it is needed. Easy to use. Oil is protected against dust inside the oilers. Includes color coded Oilers: 7718-1A for shock protection devices in watches and balance bearings of all kinds without removing cap jewel. 7719-2A for pallets, mechanical parts, oiling spots difficult to reach. and 7720-5 for train wheel pivots, cup bearings, everywhere the oiler has to be positioned before depositing oil. Swiss made, .

640.7721 **\$269.00**



640.7721

Swiss-Style Dip Oilers

Have flat steel tips for picking up oil and depositing on touch. Handles are non-rolling and color coded for quick identification. Dust caps keep tips clean.

No.	Color	Size	No.	Color	Size
420.250	Black	Ex-Small	420.256	Green	Large
420.252	Yellow	Ex-Large	420.258	Red	Small
420.254	Blue	Medium			

Above Oilers **\$3.25 each**

420.250 Package of 100 Black Oilers **\$289.95**

Four Oiler Set in Plastic Box

421.260 Set Contains Black, Blue, Green & Red Oilers **\$10.95**



421.260

Microspatula Oiler Set

Four-piece set. Spatula shaped stainless steel micro-tips pick up oil and re-deposit on contact. Ideal for applying lubricants to small moving parts or used as miniature spatulas for adhesive application. 60mm overall length. Swiss made by Grobet Red - Large; Green - Medium; Blue - Fine; Black - Extra-Fine

421.245 **\$13.95**



421.245



Pocket Clock Oiler

This is the best oiler we have ever seen. Just squeeze and you'll get the right amount of lightweight clock oil with rust inhibitors.

420.173 **\$3.25**



420.173

Economical Oil Cup Stand

Features three cups for watch oil, three grooves to hold your oilers, a hinged roll-back cover, and a non-skid rubber base.

420.101 **\$11.95**



420.101

BERGEON Oil Stand with Genuine Agate Wells

High polished chrome plated brass stand with genuine agate wells that will not absorb oil. All wells have hinged, close fitting covers. Bergeon model 30180.

641.30180 **\$359.95**



641.30180

BERGEON Alloy Oil Stand with Agate or Ceramic Wells

Die-cast alloy with four hinge-covered wells. 640.30180-A has alloy sanded agate wells; AC2 has white ceramic wells.

640.30180-A **\$134.95**

640.30180.AC2 **\$129.95**



640.30180-AC2

BERGEON Foam Absorbing Cleaning Block

Born from medical applications, this foam is dust free and very absorbent. Specially adapted for the hard cleaning of oilers and other precision tools. 3 1/8" x 1 1/4" x 1 1/4". Swiss made. Fits our 640.7011 Oiler/Screwdriver Stand. Oiler not included.

640.7011.BM **\$14.75**



640.7011.BM



420.103

420.6885



231.159



640.30514.60



231.155



231.157



230.162



420.600



640.4734
640.4735



231.0500

BERGEON Oil Cups

These color coded cups have red glass inserts for holding watch oil. Plastic case includes lid. Swiss made.

420.6885-R	6885-R	Red	\$21.95
420.6885-J	6885-J	Yellow	\$21.95
420.6885-B	6885-B	Blue	\$21.95
420.6885-V	6885-V	Green	\$21.95
420.6885-N	6885-N	Black	\$21.95

3-in-1 Plastic Oil Cup

With cover to prevent contamination. 1 3/4" diameter. India.

420.103	\$3.95
----------------	---------------

Crystal Clear Plain Alcohol Cups

For alcohol, benzene or other solutions. 231.163 has a knob.

No.	Diameter	Height	Oz	Price
231.159	2 3/4"	2"	3	\$27.35
231.161	4"	2 3/4"	8	\$34.15
231.163	4 1/4"	2 3/4"	12	\$34.65

Genuine BERGEON Alcohol/Benzine Cup with Extra Tight Lid

Covered glass cup with lid has an extra tight seal to prevent evaporation of expensive liquids. 2 1/4" Diameter x 2" High. Swiss.

640.30514.60	\$83.95
---------------------	----------------

Cut Glass Alcohol Cup

Outside diameter 2 1/2", height 1 1/2". Capacity 1 1/2 oz.

231.155	\$20.00
----------------	----------------

Clear Glass Alcohol Cup

For alcohol, benzene, etc. Ground edges form a tight seal, protecting solutions from evaporation and dust. 3 1/4" diameter, 2 3/8" High. Capacity 3 1/2 oz

231.157	\$23.70
----------------	----------------

Plastic Cleaning Cup

Thick plastic cup with lid prevents evaporation and dust. Ideal for benzene and alcohol. India.

230.162	\$3.25
----------------	---------------

Nylon Basket is safe for cleaning delicate parts

Two-piece snap together nylon basket has four compartments for safe cleaning of the most delicate parts. Ideal for use with our Fix-O-Drop bottles on page 255. 1" diameter. Swiss made.

420.600	\$14.75
----------------	----------------

Basket for Watch Cleaning Machine

Holds small parts. Screw-type basket is 5/8" in diameter and is made of fine mesh to prevent loss of parts while in solution.

231.0500	\$11.50
-----------------	----------------

Horia Small Basket for Cleaning Machines

Swiss made screw plug basket with screens on both ends. Available in two sizes.

640.4734	12mm H x 16mm Diameter	\$23.50
640.4735	13mm H x 23mm Diameter	\$23.50
230.168	9.5mm H x 14mm Diameter	\$22.00

Episurf-Neo

Episurf-Neo® is a new high performance epilame agent. Prevents oil from spreading by reducing the surface tension of the treated material. Unlike first generation epilame products that could whiten treated parts, new Episurf-Neo® results in no visual modification of the parts. You'll love Episurf-Neo®'s improved efficiency, higher resistance to cleaning cycles, and environmentally friendly formula. Use Episurf-Neo® on aluminum, copper, gold, silver, titanium, brass, steel, zirconia, silica, glass, and more. Works fast! Dip for 30 seconds and dry for 60 seconds at room temperature. Easy to use, manually in a bottle or in a cleaning machine, individually or in bulk.

820.513	100ml	\$99.00
820.514	50 ml	\$67.50

NEW!
A CAS-KER EXCLUSIVE!

820.513
820.514



Fix-O-Drop prevents oil from spreading

Swiss made from Bergeon, used as a surface treatment to prevent the spreading of oil. Ready-to-use solution treats ruby as well as steel, brass and other metals. 100 ml.

420.8941	\$134.95
-----------------	-----------------



420.8941

Fix-O-Drop Epilame Bottle

Special double chamber waisted bottle has a fluid tight screw cap with o-ring. The bottle accommodates a small basket to immerse parts in Fix-O-Drop "Epilame" for up to 2 minutes. The basket is removed immediately and dried to speed up evaporation and prevent rust forming on the parts.

150.009	\$79.95
----------------	----------------



150.009



150.013

Epilame Bottle with built-in Basket

50ml Fix-O-Drop epilame bottle with built-in steel basket.

150.013	\$74.95
----------------	----------------

Zenith Soak & Coat Jar for Epilame

Unique jar is the ideal method for immersing and coating delicate parts with Epi-Kote Epilame solution to watch and clock parts that require total coating protection. Simply fill the lower chamber with one ounce Epi-Kote, put parts to be coated in a basket and place the basket in the upper chamber of the jar. Close the cap, invert and shake jar until liquid submerges basket. Soak for 1-2 minutes, shake to drain liquid completely, remove basket and dry parts.

150.015	\$18.95
----------------	----------------



150.015

Zenith 405 "Epi-Kote" Epilame Solution

"Epi-Kote" is similar to Fix-O-Drop, used as a surface treatment to prevent the spreading of oil to unwanted watch and clock parts. Ready-to-use solution treats ruby as well as steel, brass and other metals. 100 ml. Made in USA. Available in two sizes.

420.130	30ml	\$24.95
420.132	100ml	\$62.95



420.130 -
420.132

KIMBLE® amber glass medical grade bottle as recommended by luxury watch brands

When you need to dispense liquids one drop at a time, rely on this bottle with a convenient glass dropper. Amber color protects light-sensitive Fix-O-Drop. 30ml/ 1oz. Note: Tip of dropper is not curved but can easily be done with a torch (instructions included).

150.006	\$7.25
----------------	---------------



150.006



420.125

420.126

Lubeta V105 Lubricant

Coats reversing wheels. Simple and easy to use - soak for 10 to 15 seconds, then remove excess lube with a hand blower. Cover for 15 minutes to finish drying. Avoid contact between the wheel and solvent-sensitive materials. 15ml. Swiss made by ETA.

420.125

\$34.95

Lubeta V106 Lubricant

Lubeta V106 immersion lubricant from ETA for ball bearings. Simple and easy to use - soak for 10 to 15 seconds, then remove excess lube with a hand blower. Place under glass cover for 15 minutes to finish drying. 15ml. Swiss made by ETA.

420.126

\$34.95

420.115

420.116



Novostar Swiss made precision Watch Grease

420.115 Grease for Winding Parts 30 ml

\$9.50

420.116 Grease for Barrels 30 ml

\$10.25

Nye Fulcrum Oils

Light enough to flow easily, fulcrum oils stay where applied, giving positive pivot point protection. They won't evaporate, gum, or become stringy. Give effective, long-lasting lubrication.

No.	Type	Size	Price
421.302	Clock	1 oz.	\$22.95
421.304*	Clock	4 oz.	\$28.50
421.306*	Clock	8 oz.	\$49.50
421.308*	Clock	Pint	\$65.95
421.320	Watch	1/4 oz.	\$25.50



Nye Oils

Nye Watch Oils

No.	Size	Price	No.	Size	Price
421.440	1/4 oz.	\$30.95	421.444	2 oz.	\$48.25
421.442	1 oz.	\$41.95	421.446	4 oz.	\$63.50

Nye Clock Oils

No.	Size	Price	No.	Size	Price
421.404	2 oz.	\$56.75	421.410*	Pint	\$139.95
421.408*	8 oz.	\$83.95	421.412*	Quart	\$224.95

NYE PML Clock Oil and Grease

80 Clock Oil 3 1/2 cc. Made to exacting standards. Replacement for Elgin oil.

421.470

\$5.75

MIYOTA 4R High Performance Watch Oil

General purpose oil is excellent for quartz and mechanical watches. Can be used for metal as well as plastic. Long shelf life and resists deterioration. Made in Japan.

420.366

\$29.50



420.366

Zenith 505 Ultimate HairSpring Cleaner

Evaporates fast without any oily film and leaves delicate hair springs perfectly clean and dry. Exceptional degreasing properties. Contains No chlorinated or brominated solvents. Mild pleasant odor - no ammonia fumes. Safe for the environment and it's Non-carcinogenic. Used by major watch manufacturers. Master Watchmakers and Clockmakers all agree it's the Best on the market because it is environmentally friendly and safe to use.

820.512

\$18.95



820.512



421.460

NYOIL Cleaner, Polisher, Lubricant & Rust Preventer

General purpose oil for sewing machines, guns, tools, etc. 4 oz.

421.460

\$12.95

9000 Quartz Oil

Synthetic lubricant especially designed for quartz analog watches. Does not gum up or spread under normal conditions. Non-toxic, applied by common oilers. 2 ml. Bergeon 9000-2.

420.365 **\$34.50**

8300 Grease for Watches & Clocks

General purpose, well suited to watch winding and setting parts, uncoiled mainsprings and clock springs. Use if 8200 is too fluid.

420.512 **\$22.95**

9504 Synthetic Grease

Synthetic precision quartz watch lubricant. Includes applicator. Bergeon 9504-0005, 5ml.

420.9504 **\$43.95**

8301 Clock Oil

Grease with graphite for winding mechanisms. Also used instead of 8200 series if latter is too fluid. (420.830) 20 ml.

420.0211 **\$34.95**

8302 Regular Oil for Clocks & Automatic Watch Bridles

A general purpose grease with molybdenum disulphide for use on clocks, clock mainsprings and bridles of automatic watches. Swiss. 20ml.

421.0212 **\$36.25**

8030 Natural Clock Oil #3

Standard oil for use in small to medium size clocks, music boxes, time keepers and similar movements of fine mechanics. 20ml.

420.360 **\$20.95**

8040 Large Clock Oil #4

For large clocks, tower clocks and small machines. High viscosity suitable for large mechanisms. Can be used in low temperatures.

420.362 **\$20.95**

9501 Moebius Friction Grease

Very soft synthetic for friction problems of setting mechanisms and other slow moving parts. Ideal for chronographs, diver bezels, calendar and winding mechanisms. Best for cannon pinions. Swiss. 10ml.

420.004 **\$72.50**

Moebius HP-750 Watch Oil

Synthetic watch oil for mechanical watches. Swiss. 2ml.

420.9102 **\$29.95**

Jismaa 124 Synthetic Lubricant

Synthetic and entirely mineral lubricant recommended by Ebauches S.A. and the Swiss Horological Research Laboratory. Excellent quality suitable for prolonged high friction due to long life over wide temperature range. Ideal for precision and measuring instruments, meters, relays, optical instruments. Deterioration, spreading and evaporation are non-existent. High viscosity, stability combined with remarkable smoothness. Can be used at temperatures -58° to +212°F. Swiss made. 18 gram tube.

420.118 for Steel on Brass or Bronze **\$73.00**

420.119 for Steel on Steel **\$73.00**

MOEBIUS



420.365



420.512



420.9504



420.0211



421.0212



420.360



420.362



420.004



420.9102



420.119



420.118

MOEBIUS

Moebius, Swiss
made by Bergeon

*Famous for
outstanding
performance,
acclaimed finest
for generations.*



420.364



420.905



420.005



420.0209



420.0207



421.0233



420.114



420.007



421.0219



421.0217



420.0215

8000 Moebius Mechanical Oil

Classic oil for general use on mechanical watches. Outstanding lubrication with very little spreading, low freezing point. 4 ml.

420.364 **\$19.50**

8200 Classic Watch Lube

General purpose mainspring lubricant thicker than oil but not as thick as grease. Can be used in watches 9¼ to 19 ligne, alarm clocks, pendulum, wall clocks. 20 ml.

420.0206A Bergeon 8200-20 (420.514) **\$24.75**

420.0209 Bergeon 8203-20 gelatinous, thinner than 8200 **\$37.50**

Microgliss D-5 Oil

Extremely high pressure resistance and superior lubricating for bearings. Provides excellent reduction of friction-caused wear. Swiss. 20 ml. Bergeon 5900-D5 (MD-548)

420.005 **\$49.95**

9415/2 Moebius Escapement Oil

Synthetic oil for mechanical escapements. 2 ml. Bergeon 9415-2

420.905 **\$38.95**

Moebius 941 Oil for Escapements

Specifically manufactured for use on pallets. Has a higher degree of oiliness than the standard synthetic oils. 2 ml. Bergeon 941-2

421.0233 **\$36.75**

8201 Mainspring Oil

8200 with Molybdenum Disulphide. Lubricant for automatic mainsprings insures proper bridge functioning. 20ml.

420.0207 **\$32.95**

9101 & 9103 Synt-HP Synthetic Oil

High pressure oil for precision mechanisms. Ideal for heavier mechanical watches and chronographs, gear trains, barrel arbors, and steel-steel friction partners. Excellent aging stability ensures a constant viscosity over a long time. Superior adherence capacity. Apply with needle. Swiss made. 500 or 1000 viscosity.

420.9101 Bergeon 9101-HP-500-0020, 20ml **\$157.50**

420.114 Bergeon 9103-HP-1000-0020, 20ml **\$157.50**

420.114.2 Bergeon 9103-HP-1000-0002, 2cc **\$31.50**

9104-HP-1300 Synt-HP High Viscosity Watch Oil

Same properties as 9103 with higher viscosity. Also ideal for gear board instruments, micro-motors, mini ball bearings, etc. Highest viscosity available - HP 1300. Swiss made.

420.007 Bergeon 9104-HP-1300-0020, 20ml **\$154.95**

420.007.2 Bergeon 9104-HP-1300-0002, 2cc **\$27.50**

9020/2 Synt-A-Visco-Lube

Specially designed for slower moving units and larger watch movements. Ideal for lubricating pivots of staffs, oscillating weights and other parts of automatic watches. Provides excellent lubrication to minus 68°F. 2 ml. Bergeon 9020-2

421.0219 **\$37.25**

9030/2 Synta-Frigo-Lube

High quality synthetic for precision micro-mechanics. Does not gum up or age. Highly compatible with plastics. Excellent adherence and normally does not spread. Very compatible with copper alloys and exhibits no residue at low temperatures. 2 ml.

421.0217 **\$36.75**

9010 Synt-A-Lube

General purpose synthetic, unequalled for pallet jewels, escapements and balance staffs. Use in place of all regular oils and for small clocks and instruments exposed to low temperatures to -68°. Does not spread, gum up. Extremely stable. Sub for Elgin oil.

421.500 Bergeon 9010-2, 2 ml **\$29.95**

420.0215 Bergeon 9010-10, 10 ml w/ Applicator **\$136.50**

Pure Silicone Oil #2000 never hardens or evaporates

Synthetic, slippery tough and tacky oil never crystallizes or evaporates. Operates at -35°F to +300°F. Clear, high compressibility, nontoxic, non-bioactive, non-greasy, high water repellancy, high oxidation resistance, high dielectric strength, high shearability. Available in three viscosities.

10 Centistokes for fine automatic and jeweled wristwatches, meters and fine mechanisms. Remains liquid at (-40°F).

50 Centistokes for fine pocket watches, unjeweled mechanisms.

100 Centistokes for lubricating clocks, unjeweled bearings, parking meters, large unjeweled or jeweled mechanisms.

420.001	10 Centistokes	\$10.50
420.002	50 Centistokes	\$10.50
420.003	100 Centistokes	\$10.50



420.001
-420.003

420.0101

Quicken® NanoLube is formulated for horologists

Contains 0.1 to 4 nanometer synthetic diamond ball bearings which eliminate friction and wear, and never wear out.

NanoDiamonds adhere to the applied surfaces even after the carrier oil has evaporated. On average, it takes 80,000 NanoLube particles to span the width of a human hair - and all particles are spherical, synthetic diamond.

420.0101	NanoLube for Watches 1.5ml	\$31.50
420.0100	NanoLube for Clocks 2.0ml	\$32.50



420.006



420.008

Fomblin Grease for Mechanicals

Specially developed white homogeneous grease for mechanical parts subject to friction of medium pressure when mineral and standard synthetic lubricants break down due to temperature changes and exposure to air. Also useful for greasing all types of joints as well as special optical and micro mechanical instruments. 10ml.

420.006		\$40.75
----------------	--	----------------

P-125 Chronogrease

An excellent braking lubricant for automatic barrels. 5 grams.

420.008		\$54.95
----------------	--	----------------



420.475

MolyKote® DX Grease for Bearings

Formulated for plain bearings and surfaces for long term lubrication, this soft white lithium extreme pressure paste has a high load carrying capacity. Reduces running-in damage and seizure. Suppresses stick-slip, prevents fretting corrosion. Weather and water resistant. Three year shelf life. 50 grams. Made in Germany.

420.475		\$31.50
----------------	--	----------------

Silicone Gasket Speed Lubricator®

Preloaded with the finest quality silicone grease, will lubricate hundreds of rubber and plastic gaskets up to 2 1/2" and threaded watch backs. Tough, waterproof, resists wash-out. Rubber will NOT deteriorate!

420.104		\$9.95
----------------	--	---------------



420.104

Silicone Foam Swabs

Handy swab saturated with silicone grease to lubricate O-Rings without removing from watch case. 1" long on wooden stick.

420.106		\$6.50
----------------	--	---------------



420.106



420.107



421.0325



421.0340A



420.0300



421.0213



430.800



420.105



420.112

Syringe loaded Silicone Lubricants

Needle nose applies lubricant into especially hard to reach areas. 420.107 syringe is great for sealing crystals, O-Rings, gaskets and threaded watch backs, diving cameras and other fine instruments. Heavier 420.108 for plastic and rubber gaskets, and 420.109 is the thickest for all waterproof watches and for sealing vacuum evacuated watches. Will NOT deteriorate rubber.

420.107 Regular	\$7.50
420.108 Heavier	\$8.25
420.109 Heaviest	\$8.75

"KT-22" Lubricant in Applicator

Specially designed, flexible applicator is ideal where precision lubrication is critical. Loaded with KT-22 lubricant.

421.0325	\$7.75
----------	--------

"KT-22" Microlubricant & Sealer

Setting stem and winding gear lube. Never breaks down, creeps or bleeds. Completely vapor-seals sleeve. Completely waterproofs screw-back cases. Protects against condensation. Seals plungers. One ounce.

420.0300	\$4.50
----------	--------

Cas-Ker Silicon 7 Watch Sealant

High vacuum pressure waterproof watch sealant. Prevents leakage of moisture into the case due to worn gaskets. Will not evaporate, vaporize, harden or break down. Will not affect oils. Unaffected by moisture, salts, acids, fungus, or alkalis.

421.0340A	\$7.50
-----------	--------

Moebius 8513 Silicon Case Sealant

A heat resistant case sealant grease containing silicon, used for the sealing of waterproof cases and crowns. 10 ml.

421.0213	\$36.95
----------	---------

White Silicone Grease

This multipurpose grease is ideal for sealing waterproof watches. Keeps O-Rings soft. France. 25 grams.

430.800	\$5.50
---------	--------

Seiko Silicone Grease

Silicone Grease 50 is proven highly effective in waterproofing crowns, crystals and case backs. 500,000 Centistokes. Japan.

420.105	\$13.75
---------	---------

Silicone Sealing Grease

Silicon based sealing grease for watch cases, push buttons and correctors. Japan. 25cc.

420.112	\$5.50
---------	--------

LOCTITE® 243™ Thread Locker

General-purpose, medium strength threadlocker with improved oil tolerance. For fasteners up to 3/4" (20 mm) diameter. Eliminates the need to use a primer on inactive metals such as plated parts and stainless steel. Oil tolerant curing on as-received fasteners without cleaning. Upgraded thermal resistance for continuous temperatures to 360°F (400°F intermittent). Full cure in 24 hours. Bergeon 6879, 10ml

640.6879 **\$33.95**

Loctite 221 Threadlocker Low Strength/Low Viscosity

Locks and seals threaded fasteners that require easy disassembly with standard tools. Cures when confined in the absence of air between close fitting metal surfaces. Prevents loosening and leakage from shock and vibration. Avoid shearing set screws, small diameter or long engagement length fasteners. Bergeon 5670-10, 10ml

640.5670 **\$34.95**

Loctite Threadlocker 270 High Strength/Stud Lock

Maximum strength stud locker for fasteners up to 3/4" (20mm). Secures large studs and bolts. Intended for parts that do not require disassembly. Cures fast and reliably on most metal surfaces. Seals threads against industrial fluids. Bergeon 6878, 10ml

640.6878 **\$33.95**

Loctite 603 Retaining Compound

Tolerant of oil and other contamination. Seals and secures cylindrical assemblies up to 0.005" diametral clearance. Fixes in 10 minutes. Prevents corrosion. Ideal for locking crowns to stems. Bergeon 5671-10, 10ml

120.605 **\$39.95**

Vissin Swiss Broken Screw Extracting Solution

Simply place a plate or bridge in a recipient and cover it with Vissin. Boil slowly until a black substance exudes from screwwhole. Rinse in water and clean with benzine. Safe as long as your bezel is not a base metal. *Use only on stainless or high grade steel.*

230.165 **\$12.95**

Crucible for Vissin

Fireproof China bowl is ideal for using Vissin solution to extract broken screws. 4" diameter, 1 7/8" deep. Made by Halden-wanger, Bergeon 4668.

230.166 **\$49.95**

Tripod for Vissin Crucible

Holds china bowl 230.166. Metal stand measures 5 1/2" high, 4 1/4" diameter top ring. Bergeon 4669. (Crucible sold separately.)

230.167 **\$63.95**

Screw Loosening Fluid

Loosen frozen screws with this powerful fluid in a handy syringe. 6cc (.2 fl oz).

230.164 **\$19.95**

Kroil loosens frozen metal parts

Amazing solvent penetrates openings as small as one millionth of an inch. Kroil creeps to loosen the toughest rusted metal joints in minutes. Dissolves gum, dried grease and oil without attacking metal. Provides lubrication, dissolves and prevents rust. 8 oz.

420.000 **\$16.95**



640.6879

640.5670

640.6878

120.605



230.167
Tripod only



230.166



230.165



230.164



420.099



420.000

Terminator Rust Remover

An amazing rust remover and inhibitor for mild to deep rust. It's safe, simple, effective. Can be used over and over until performance drops off. Easy to use, non-toxic, non-corrosive, non-flammable. No fumes or odors. Won't affect rubber, plastic, PVC, most paints. Cannot be shipped by air. 2 oz.

420.099 **\$10.95**



230.233



820.509

820.507

Clean quartz movements in seconds with PlastiCleanII

Clean plastic and metal quartz movements with one solution. Easy-to-use, efficient and environmentally safe. PlastiClean's powerful microscopic cleaning action penetrates tiny crevices in movements, lifting out dry oil and residue. Tested to be completely safe for all plastic and metal quartz watch & clock movements. Remove dial and battery from watch before using. 13 oz. aerosol. Cannot be shipped by air.

230.233

\$18.75

One Dip Cleaner and Degreaser

Cleans rapidly, effectively and safely and protects as it cleans. Remove oil, lubricants, wax, adhesives, ink, flux and more from a wide variety of products, including watches and watch parts. Thorough and gentle cleaning. Use as dip or spray, wiped or brushed in ultrasonic or as a soak. Cannot be shipped by air.

820.507 8 oz

\$16.50

820.509 32 oz

\$43.95



540.135



230.150

Cas-Ker CleanJet

Ultra-filtered portable source of ultra-clean gas for precision removal of dirt, dust, lint and particulates. Blast away dust from watches and clocks, benches, office and computer equipment, photographic film and equipment, and more. Up to 100 PSAI at 68°F. Extender tube provides a pinpoint jet to the smallest, hard to reach places. Leaves no residue. Contains no ozone-depleting CFC's. Compare our 10 oz size to other brands containing only 8 ozs. Cannot be shipped by air.

230.150

\$11.50 ea 12 @ \$10.25 ea



540.093

Rubber Dust Blower

All rubber construction for long life. Special valve in tip provides strong, clean, directed air stream. 4" long.

540.135

\$5.25

Rubber Blower with plastic tip

Rubber blower has a metal nozzle and inlet valve. Nozzle is plastic-sheathed to prevent marring of delicate parts. Swiss.

540.093

\$16.50



590.890

Genuine BERGEON Dust Blower

Bakelite blower will not roll off the bench. Bergeon 30540.

590.890

\$36.95



640.5733

Bergeon Rubber Blower

Bergeon 5733 dust blower features a flat bottom to allow an upright base that won't roll off your bench. Durable rubber blower with PVC tip. The extra valve on the bottom of the bulb prevents air from entering by way of the nozzle.

640.5733

\$13.50

More watch cleaning supplies on pages 13 - 20.

Looking for a floor model or hood dust collection system? Find it on pages 25-27.

Watch Crystal Cement

Seiko S-310 Mineral Glass Crystal Adhesive

A two component epoxy for mineral and glass watch crystals. Superior bonding and high resistance to shocks. Forms perfect transparent seal, excellent stability, non-flammable and harmless to case, dial and movement. Just a small quantity is required. Mix 50 - 50. Sets in 24 hours at room temperature.

120.0310 **\$17.25**

Seiko S-314 UV Adhesive

Curing adhesive and sealant uses ultraviolet light to bond metal to glass instantly. Clear, non-yellowing bond. 10g.

120.0314 **\$31.95**

G-S Hypo-Tube Crystal Cement

Unique precision applicator and pinpoint tip. Dries clear and allows parts to be positioned before setting. Also jewelry and optical. USA. 1/3 oz.

120.205 **\$5.95**

Rocket Cylinder Cement

Specially made tube cement for cementing and dustproofing unbreakable watch crystals. Can be used safely with any crystal.

120.001 **\$6.50**

G-S Precision UV Glue Applicator

Fill this empty bottle with up to 1/6 fl. oz. of your choice of UV glue and have the advantage of the G-S precision hypo-tube applicator. Ideal for watch crystals, glassware and optical. Reusable - clean and refill.

120.003 **\$6.25**

Sternkreuz-Minecol Adhesive for Mineral Glass Crystals

Special cement for fitting mineral glass crystals hardens by UV rays. Comes in a fine hypodermic syringe for pinpoint accuracy. Cures in 2-3 minutes under a UV lamp. Black lightproof storage bottle protects Minecol against hardening when not in use. 2ml.

120.007 **\$19.95**

Clear UV Adhesive

Uses the power of the sun or a curing lamp to bond metal to glass instantly. Clear, non-yellowing. No-mess needle applicator. .07 oz.

120.226 **\$6.50**

120.002 Needle Tip for UV Glue **\$1.50**

UV Glue Curing Lamp

Made for curing ultraviolet crystal cement. Black plastic fixture measures only 7 1/2" x 4 1/2" x 2 7/8". Takes up very little space. Includes 6" UV bulb, 5 1/2' cord with 2-wire plug and on/off switch. 110V AC. Two minute curing time.

130.900 **\$39.95**

130.901 Replacement Bulb **\$10.95**

120.0310



120.0314



120.205



120.001



120.003



120.007



120.226



130.900



Super Glue & Adhesives



121.214



120.222



120.602



120.603



120.228



120.233



130.905

Mascot® Instant Adhesive

High performance, extended range cyanoacrylate adhesive bonds metals, most plastics, rubber, ceramics and glass. Requires only a clean surface. Bonds colorless and sets in about 30 seconds. Gel, No-drip formula fills gaps and is ideal for use on vertical surfaces. 3 Gram Tube.

121.214

\$4.75

Loctite Hi-Performance Super Glue

Premium glue is Faster acting - longer lasting, provides a stronger bond and works on more materials than regular super glues. 60% more product than tube. 5 gram large clog-free bottle. USA.

120.222

\$3.95 ea 6@ \$3.50 ea 12@ \$3.35 ea

Gorilla Glue - the toughest glue on earth

Gorilla Brand Premium Glue is the all purpose, interior - exterior glue ideal for most repair and bonding needs. Bonds wood, stone, metal, ceramic and more! Incredibly Strong. 100% Waterproof. Made in Denmark. 2 fl oz.

120.602

\$6.50

Gorilla Super Glue

Thicker for easy flow control. Stronger, faster - bonds wood, metal, ceramic, rubber, leather, paper and more! Sets in 10-30 seconds, full cure in 24 hours. Anti-clog - keeps glue fresh use after use. Two 0.11oz tubes.

120.603

\$3.75

QuickTite Brush-on Super Glue

QuickTite works faster and holds stronger on more surfaces than ordinary instant adhesives thanks to a patented additive. Brush-on applicator spreads evenly. Use in close fitting areas on wood, paper, china, rubber, metal and more. 0.18oz bottle.

120.228

\$5.75

Instant Glass Glue bonds all glass without a UV lamp

The only patented instant glue for glass. Regular super glues don't work on glass. The bond stays flexible and remains waterproof and heat resistant. Clear bond line makes repairs disappear. Bonds in 60 seconds, cures in 24 hours. Does not require an ultraviolet lamp for curing. 2 gram tube.

120.233

\$4.95

UV Curing Lamp with Timer

Ideal for curing ultraviolet crystal cement (see front cover). White plastic fixture measures 8"W x 4"H x 9.5"D. Includes four 9W UV bulbs, 5.5' cord with 2-wire plug, on/off switch and timer with 90 and 120 second selections.

130.905

\$119.95

130.906 Replacement Bulb

\$10.50

Super Glue and Epoxy

VIGOR® Super Glue

- Excellent for small surfaces, strong ethyl adhesive bonds any combination of metal, plastic, rubber, ceramic, or glass.
- Sets and cures rapidly at room temperature.
- High strength single component - no mixing.
- Requires no surface treatment beyond cleaning.
- Excellent resistance to chemicals and low temperatures.
- Bonds colorless and transparent with almost no shrinkage.
- Low viscosity ensures smooth spreading to entire bonding area with a minimum amount of glue.

45/60 Series - Setting time of 45-60 seconds

No.	Size	Price
121.218	2 Gram Pen	\$3.50
121.215	2 Gram Tube	\$3.50
121.216	2 Gram Tubes - 5 Pk	\$16.35/pk of 5
121.217	20 Gram Bottle	\$11.10

10/20 Series - Setting time of 10-20 seconds

Medium viscosity for gap filling and uniform coverage.

No.	Size	Price
121.219	2 Gram Tube	\$3.50
121.220	2 Gram Tubes-5 Pk	\$14.95/pk of 5
121.221	20 Gram Bottle	\$11.10

Instant Adhesive

Sets in 30 Seconds. Extended range Cyanoacrylate adhesive bonds metals, most plastics, rubber, ceramics and glass in seconds. For close fitting surfaces. Low viscosity insures maximum spreading with a minimum glue. Colorless. 3 gram no-clog bottle.

120.212	\$3.25
---------	--------

Loctite 496 Quick-Setting Adhesive

Single component medium viscosity (100-150) adhesive. Fast curing cyanoacrylate sets in just 20-40 seconds. High strength - specifically for bonding metals, also bonds glass, plastic, wood, rubber and other close-fitting smooth-surface materials. 20 gram.

120.302	\$67.95
---------	---------

Jewelers' Epoxy

Especially formulated epoxy adhesive for repairing jewelry and all hobbies and crafts. Mixed resin and hardener sets in 4 minutes at room temperature. Maximum strength is reached after one hour. Dries clear, will not shrink and is unaffected by oil or water. One fl oz.

121.0451	\$5.85
----------	--------



121.218



121.215



121.219



121.217



121.221



121.216



121.220



120.302



120.212



121.0451



120.330

Epoxy 330 in Tubes or Bottles

Water clear glue made for bonding gem materials to metal findings. Also used for invisible bonding of glass, china, ceramics, stone, metals and other non-porous materials. Fast setting - sets up in 30 minutes and hardens in 2 hours.

120.330 Two 1/2 fl oz Tubes **\$5.95**

120.331 Two 4 fl oz Bottles **\$22.95**



120.331



120.170

Superfast 5 Minute Epoxy

Clear epoxy chosen by industry for its versatility. 1 oz plunger.

- Sets in 5 minutes.
- Bonds wood, metals, ceramics, china and glass.
- High strength, resistant to most chemicals.
- Fills gaps and makes strong water resistant repairs.

120.170 **\$5.25**



381.325

Attack Glue-Dissolving Compound

Dissolves cured epoxy and polyester resins so you can quickly and easily separate misaligned materials, or clean cured resins from metal, stone, glass, wood and many other materials. Cannot be shipped by air. 8 fl oz.

381.325 **\$15.75**



120.224

OPTICON Permanently Seals Fractures in Stones

Opticon permanently seals fractures in flat or curved, polished or unpolished stones. Helps eliminate fracture reflection and structural weakness and fills pits. High penetration, hardens clear. 2 part, 9oz kit w/ instructions. Cannot be shipped by air.

120.224 **\$31.50**



640.7216

Crystal Cleaning Stick

Removes glue residue from crystals. 8" long, 5mm diameter with one flat end and one pointed end. Natural material won't scratch or leave traces, and can be sharpened as needed.

640.7216 **\$19.95**



130.393

G-S Hypo Fabric Cement

This fabric cement is great for fabric, textiles, leather, plastics, arts & crafts, appliques, costuming, foam, yarn and home decor. Precision applicator allows precise amount of cement to be applied to intricate fabric and textile projects. No mess and will not bond fingers. 1/3 fl oz.

130.393 **\$6.25**

Sealing Wax

For sealing packages, envelopes, and other fancy stuff. Melting point 170° F. Four 1/4 lb. red sticks.

121.225 **\$27.95**



121.225

Shellac Sticks

Very handy and versatile material in a convenient form. Opaque stick is widely used for setting stones, and temporarily holding objects. Transparent stick inconspicuously fills holes, dents and scratches. Both are 7" long. Heat to apply.

121.230 Opaque Stick **\$17.50**

121.231* Transparent Stick **\$29.95**



121.230

Orange Flake Shellac

Sticky when heated, making it useful for holding objects being chased or engraved. 6oz.

121.227 **\$19.95**



261.103

Beeswax

When rubbed on surface, leaves a film on which design can be marked. Also used as a lubricant for sawblades and wire drawing.

261.100 1 oz. tube **\$3.25**

261.103 1 lb. cake **\$17.35**

261.100



121.227

Chinese White Water Color

When melted, can be dabbed or brushed onto surface so that a pencil mark will leave an impression.

261.160 **\$18.50**



261.160

Diamond Setter's Cement

Melted and applied to a wooden dowel, it securely holds diamonds or stones for polishing operations. 4" x 4" x 5/16".

121.208 **\$39.95**



121.208

Find a great selection of engraving tools on pages 128 - 132.

"The Little Torch" Lets You Solder the Impossible Quickly & Easily



140.001



140.004



140.00405

Our miniature welding torch maneuvers easily in areas impossible to reach with conventional torches. Produces a perfectly controlled, stable flame hot enough to melt metals, glass and ceramics with thread thin flames up to 6300°F. Color-coded oxygen and fuel gas lines and valves help prevent errors. Uses acetylene, propane and propylene based fuels. Welds, brazes and solders an unlimited range of materials with ease.

- Welds with incredible precision.
- Brazes the tiniest elements with uncanny accuracy.
- Solders hard or soft with amazing versatility.
- Infinite heat control at a variety of flame settings.

Little Torch can be used with acetylene, LP gas, or hydrogen. The valves, connections and hoses are all color keyed for convenience and safety. Regulators and tanks may be purchased locally.

"Little Torch" Fuel Temperatures:

- Acetylene 5900° F - 6300°F
- Butane 4995° F
- MAPP 5300° F
- Hydrogen 4850° F
- Natural Gas 4600° F
- Propane 4780° F

The Little Torch™

Little Torch Starter Kit

Ideal for use in the fully equipped shop. Includes aluminum alloy torch body, 5 copper tips, 8 feet of durable hose, adapters to your regulators, and complete instructions. Smith #23-1001D

140.001

\$145.95

Little Torch Starter Kit with Regulators for Disposable Tanks

Includes #5 Tip, Cylinder Holder, Preset Propane Regulator, Preset Oxygen Regulator and 8' Hose. Allows maximum portability and may be used where larger pressurized cylinders are not allowed.

140.004

\$242.50

Little Torch Sets with Regulators

Each set contains a "Little Torch" Kit No.140.001, universal Oxygen Regulator No.140.035 and one of the following fuel cylinder regulators as noted.

- LP, Propylene, MAPP, NPG & POL cylinder regulator 140.040.

140.00403

\$379.95

- Acetylene type MC regulator 140.039.

140.00405

\$379.95

"Little Torch" Extra Tips

Curved Tips

No.	Orifice	Size	Price
140.011	1*	.003"	\$26.25
140.012	2*	.006"	\$26.25
140.013	3	.011"	\$26.25
140.014	4	.020"	\$26.25
140.015	5	.029"	\$26.25
140.016	6	.037"	\$26.25

*Tip sizes 1 and 2 are for use with oxygen and acetylene or oxygen and hydrogen only.

SMITH EQUIPMENT

SMITH Equipment Regulators and Inlet Connections

Designed for the "Little Torch", but can be used with any torch. Easy to read. Two stage regulators feature sensitive performance, pressure will not fluctuate with multiple torch hook-ups. UL listed.

Gas	Number	Stage	Price	Fits Cylinder
Oxygen	140.035	Single	\$127.00	All industrial
Oxygen	140.03502	Two	\$218.30	All industrial
Acetylene	140.036	Single	\$127.00	Type B & Autolite
Acetylene	140.037*	Single	\$129.00	Commercial Acetylene
Acetylene	140.03702	Two	\$218.30	Commercial Acetylene
Hydrogen	140.038*	Single	\$133.40	Hydrogen
Acetylene	140.039	Single	\$127.00	MC
Propane	140.040	Single	\$127.00	POL
Propane	140.04002	Two	\$258.00	POL



140.035

140.039

Preset Regulators

Purchase cylinders locally.

140.041	For Disposable Oxygen	\$59.95
140.042	For Propane Cylinders	\$59.95

Torch Hoses

Hose assemblies are supplied with connections. Available in 8' lengths and 2 colors: Red for fuel gas and green for oxygen.

140.052	8' Red	\$35.25
140.053	8' Green	\$35.25



140.041

140.042

140.052
140.053

Heating and Melting Tips

Multiple orifice design gives you maximum melting power and increased versatility for melting gold, silver or bronze in a crucible. Use with oxygen and acetylene. Supplies 3000 BTU's for temperatures up to 6000° F. 3" long and melts up to 3 oz. of metal.

140.030	\$37.50
----------------	----------------

6" Tip - Use with propane or natural gas at temperatures up to 5200° F. Propane supplies 5000 BTU's, natural gas 2420 BTU's. 6" long and melts up to 5 oz. of metal.

141.031* (not shown)	\$56.85
-----------------------------	----------------



140.030

The ORCA® Torch

An economical answer to your soldering needs

- Requires no expensive tanks or gauges.
- Works without bottled oxygen.
- Simply draws from the air that surrounds us.
- Adjustable valves fit small refillable propane tank.
- Flame versatility with three interchangeable tips (Small, Medium & Large).

141.070	Torch Kit includes Torch Body, Hose, 3 Tips	\$99.50
141.071	Regulator for 1 Torch fits 20lb Propane Barbeque Tank	\$38.10
141.072	Regulator for 2 Torches fits 20lb Propane Barbeque Tank	\$57.80
141.07201	Disposable Regulator fits Disposable Propane Tank	\$41.75
141.07202	Large Tip (up to 2400°F)	\$23.10
141.07203	Medium Tip (up to 2300°F)	\$20.00
141.07204	Small Tip (up to 2000°F)	\$12.65
141.07205	50' Hose w/Both End Connections	\$31.50



141.070

141.07201

141.071

141.072

HOKE-JEWEL Torches



Standard Model Hoke-Jewel Torches

For quality, insist on the HOKE-JEWEL torch, most widely used by professional jewelers for daily work. Ideal for precision metal melting, soldering, brazing and welding. Fingertip control of valves and selection of tips allow user to select type of flame required, from large brush to pinpoint. Valves work easily and surely, with precise mixing of gas and never any leakage. Machined from solid brass stock and seamless brass tubing and completely nickel-plated. Overall length is 9". Inlets use standard 1/4" hose.

No.	Gas System	Pilot	Tips	Price
141.120	Oxygen & Acetylene	No	4	\$65.75
141.121	Oxygen & Artificial Gas	Yes	4	\$69.15
141.122*	Oxygen & Natural Gas	No	3	\$69.15
141.123	Oxygen & Butane or Propane	No	4	\$69.15

NOTE: Pilot light on No. 141.121 allows continuous flow of gas for quick ignition. This is intentional and should not be misunderstood as a faulty leak.

Extra Tips for Standard Model HOKE-JEWEL Torches

Gas System	Flame Size				Price
	Pinpoint	Pencil	Small	Large Brush	
Oxygen & Butane or Propane,					
Oxygen & Artificial Gas	141.130*	141.131*	141.132*	141.133*	\$3.70
Oxygen & Acetylene	141.136*	141.137*	141.138*	141.139*	\$3.70
Oxygen & Natural Gas	—	141.142*	141.143*	141.144*	\$3.70

Reinforced Rubber Hoses

3/16" diameter x 12 1/2' long twin fuel gas/oxygen hoses.

141.0780 with two 9/16" "B" fittings	\$48.50
141.0781 with 3/8" "A" and 9/16" "B" fittings	\$32.50

Hose Connections - Use on regulators for standard ID hoses.

for Oxygen	for Fuel Gas	Size	Price
141.198	141.196	3/8" - 24 for 3/16" ID	\$5.30
141.195	141.199	9/16" - 18 for 3/16" ID	\$5.30
141.178	141.197	9/16" - 18 for 1/4" ID	\$5.85

The GENTEC® Jeweler's Small Torch

- Braze and solder material from the tiniest up to 1/8" thick steel.
- Melt up to 3 ounces of silver.
- Provides stable, precise concentrated feather flame up to 6000°F.
- Easy manipulation in very tight places.
- For use with Oxygen-Acetylene.
- Includes torch handle, 5 different size copper tips (2-6) and 12 feet of hose. Purchase regulators and tanks locally.

140.500 **\$125.95**



Set of Six Adapter Tips and Adapter

Expand your HOKE-JEWEL torch's capabilities. This precision adapter set is ideal for all soldering, welding and melting jobs. Tips give you a non-oxidizing flame, so less pickling is required and jewelry comes out cleaner. Change tips in a few seconds. Adapter tips are not recommended for use with acetylene.

141.060 **\$28.75**

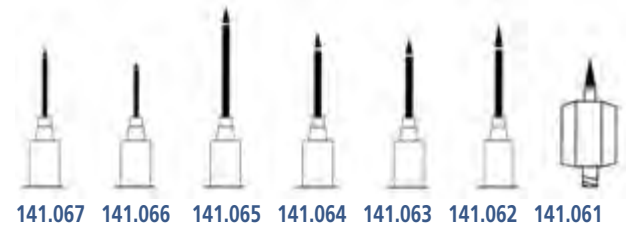

Replacement Tips for No.141.060

141.067 Produces a super micro flame for complex soldering	\$5.05
141.066 Produces a mini micro flame	\$4.75
141.065 RED DOT - Increase accessibility to difficult places with micro point flame and projection tip	\$4.75
141.064 Equivalent to standard #1 tip, stronger with smaller flame	\$4.75
141.063 YELLOW DOT - Soft, direct flame	\$4.50
141.062 For large areas of soldering hollowware in gold and silver	\$4.75
141.061 Adapter w/o tips for melting gold, silver, platinum	\$9.45



141.178 - 141.199



140.500

Four contacts on this electronic Torch Lighter allows you to light in any position.

The Appa® automatic spark torch lighter uses a patented technique that offers convenient single-hand ignition. Simply turn on the power switch, touch the torch on any ignition button, and the torch tip will ignite instantly via a small spark from the internal electrode. The lighter is safe, easy to use, and uses 2 AA batteries (not included). Dimensions: 3"W x 2"H x 3"D.

140.205 **\$39.95**

TorchMate Automatic Torch Lighter

Battery operated torch lighter is simple to operate. Just press the torch tip to the electronic igniter switch, a small spark from the electrode will ignite the torch instantly. Requires two "AA" batteries (not included).

141.204 **\$39.95**

Torch Lighter

Makes sparks to light gas without open flame. Includes one flint.

141.205 **\$9.95**

141.206 Box of 5 flints **\$2.95**

Torch Holders

Mount anywhere on your bench to accommodate most torches.

141.202 Low bracket-type, wide top **\$9.80**

141.201 Hook-type **\$4.50**

141.200 High bracket-type, narrow top **\$7.75**

Smith Magnetic Torch Holder

Versatile, magnetic, third hand holder keeps your "Little Torch" nearby on your bench. Use it right on the stand when you need both hands free. Heavy metal base keeps it safely in place and has seven holes for extra tip storage.

140.790 **\$37.75**

Weighted Torch Stand

A quick and convenient place to rest your torch while working. Stainless steel rod ensures easy placement and removal of the torch without sacrificing safety. Cast iron base provides strong, balanced support, as well as storage for your extra tips.

141.203 **\$24.50**



Tubing

For connecting torches, bunsen burners, compressors, etc.

141.188 Clamp for 1/4" **\$2.45**

141.189 Green reinforced oxygen 1/4" ID **\$4.50**

141.190 Red reinforced fuel gas 1/4" ID **\$4.25**

141.186 Black rubber 3/16" ID **\$3.50 per ft**

141.0730 Black rubber 1/4" ID **\$2.00**

141.191 Pure gum 5/16" ID **\$2.15**

Torch Wrench

Fits all nuts on torches listed in our catalog.

141.164 **\$32.45**



140.205



141.204



141.205



141.201

141.200



140.790

141.202



141.164



141.203



140.202



BLAZER Excalibur Combination Soldering Iron, Hot Air Blower and Torch

Self igniting cordless butane torch comes as a multi-purpose kit which includes a wide range of tips, wrench, sponge and a tube of solder for all your needs. Ideal for professional use including; jewelry & watch repair, electronic system repair, woodworking, lapidary, optical repair, general maintenance and professional repair jobs. Piezo electric instant ignition system provides a quick start-up in any mode.

- Temperatures: Soldering tip 480-932°F, Heat tip max. 1110°F, Torch max. 2395°F. Burn time 70 minutes.
- Five interchangeable tips; Reflector, Hot Air Blower, Hot Knife, 3.5mm Chisel Tip and 3mm Diagonal Tip.
- Includes tube of 60/40 coiled silver solder, tip cleaning sponge and sturdy, compact case.

For best results use Blazer Triple Refined Butane Gas (not included with torch, purchase locally).

140.202

\$62.95



For best results use Blazer Triple Refined Butane Gas (not included with torch, purchase locally).

140.201



141.212

BLAZER Spitfire Micro Torch

Refillable butane torch for industrial and home use features a unique angled head and a slim easy grip body. Ideal for DIY, jewelry repair, culinary use, hobbies & crafts, electronic repairs, wood working, plumbing, heat shrink tubing, optical repair, first aid and survival kits, outdoor use and much more. Features 2500°F blue flame, precision flame control with flame range 1/2" to 3", Piezo self-ignition, lightweight & portable, wind resistant torch flame, 30 minute continuous burn time, child-resistant safety trigger, 6"H x 3"W x 2 1/2" diameter. Made in Japan.

140.201

\$42.00

BLAZER Stingray Micro Torch

Refillable butane torch, 2500°F blue flame, Piezo instant ignition.

141.212

\$77.50



141.285 - 141.286



140.287

Alcohol Lamps and Accessories

Alcohol lamps to be filled with denatured ethyl alcohol only.

Simplicity Alcohol Burners

Flame can be adjusted by raising or lowering split sleeve. Faceted bowl measures 3 5/16" in diameter and holds 4 oz. fuel.

141.285 Wick Diameter 1/2"

\$12.60

141.286 Wick Diameter 1/4"

\$10.30

Simplicity Burner with Screw

Screw adjustment for wick. Faceted bowl diameter is 3 5/16" and holds 4 oz. of fuel. Supplied with 3/16" diameter wick.

140.287

\$19.25



141.278 - 141.279

Glass Lamps

Nickel-plated brass with screw adjustment for wick. Includes 3" wick, 3/16" diameter. Bases are 2 1/2" diameter.

No.	Height	Capacity	Price
141.278	1"	1 1/2 oz	\$15.35
141.279	1 3/4"	3 oz	\$15.80

Wicks for Alcohol Lamps

Replacement Wicks.

	Per Doz
141.292 1/2" diameter	\$14.95
141.293 3/16" diameter	\$8.25
141.294 1/4" diameter	\$8.25

PRO-CRAFT® Electric Soldering Machine

- No torch or gas tanks needed.
- Used for hard or soft soldering up to 2000° F.
- Demagnetizes watch movements, small instruments and tools.
- Low voltage unit is shock resistant. Your hands may safely touch any part of the carbon holders or contact clips.

Easy to use machine for soldering rings, jewelry, eyeglass frames or any piece where hard or soft solder is needed. Heat range for soldering very light to heavy items. Heat is produced electrically, without flame, by touching a carbon electrode to the work to be soldered. Current passing through the carbon will heat the object in seconds. Carbons are copper plated to insure good contact. Large carbon holder can be adjusted to use carbons both horizontally or vertically and is low enough so that both hands can rest comfortably on the bench. Maximum 1000 watts. Measures 10¹/₄" x 6³/₄" x 4¹/₈". Set contains foot control switch, 3 large carbons (pencil, cylindrical and cylindrical flat), 2 small carbons, contact rod, clamps for small and large items, stand for large carbon and instructions.

541.050* 115 volt Model Shipping weight 12 lbs. **\$375.00**

541.050X* 220 volt Model **\$499.00**

* Special Order. Please allow 5-7 business days for delivery.



541.050*

Lenk Soldering Pencil

Melts solder in 90 seconds. Perfect for fine jewelry work. 25 watts.

541.0960 **\$24.25**

541.0961 Pack of 2 replacement tips **\$7.35**



541.0961

541.0960

Soldering Piks

Deluxe Titanium - Specifically made to lift minute drops of molten solder. A 35 high-tech titanium rod to which solder cannot stick. Non conductive, non-roll handles assure ease of handling.

540.930 6¹/₄" Blue w/long narrow point **\$4.95**

541.774 6" Silver **\$12.45**

Alloy Pik - Made with a special alloy, the point can be bent to any shape without breaking. Hardwood handle, 6¹/₄" long.

540.771 **\$4.75**

Tungsten Pik - Can withstand higher temperatures than titanium piks. Will not contaminate platinum.

540.772 **\$6.95**

Niobium Pik for Platinum - A little known metal with a sky high temperature of 4,470°F. The only metal where contamination is virtually impossible. Excellent for platinum. Niobium can be bent to the desired angle without breaking.

540.775 **\$6.50**

Colored titanium pick prevents solder contamination

Avoid solder joint lines due to contamination. Use a different color pick for each gold karat and color. Long-lasting titanium tip collects the exact amount of solder. Grooved aluminum handle quickly transfers heat away from operator. Lengths 6¹/₄", 1⁵/₈" tip. Not for use with platinum.

540.776 (Choose Red, Yellow or Blue) **\$4.25 ea**

Premium Solder Pick with Shield

Non-slip comfort grip and non-rolling stainless steel heat shield protects and allows extended use. Includes two 1/16" diameter replaceable tungsten steel tips. Made in USA. Length 6³/₄".

540.955 **\$20.95**



540.930

541.774

540.771

540.772

540.775

540.776

540.955



570.299

570.0398

480.230

570.759

570.760

570.761

570.762

480.405

La Vaque Head & Shank Tweezers

Visual alignment for soldering settings accurately the first time, every time. Curved, grooved tip securely holds the shank in place while the transparent glass base secures the head, allowing you to see from the top and all sides. Replaceable high-temperature glass withstands direct flame and soldering temperatures required for gold and silver, lasting for dozens of jobs. Not recommended for platinum and other metals that require higher soldering temperatures.

570.299	\$32.95
570.299.1 Replacement Glass	\$11.75

Head & Shank Tweezers

Slide-locking tweezers securely holds ring shank and setting in position for easy soldering of solitaires. India.

570.0398	\$8.95
----------	---------------

Ring Holding Tweezers

Ring holding tweezers holds from inside shank for easy soldering. Positions two rings being soldered together as a set. India.

480.230	\$3.95
---------	---------------

Tweezers leave your hands free to solder

Heat resistant fiber grips and permanent tension self-locking serrated jaws. Wire stand permanently attached to hold objects above soldering surface. 6 1/2" long.

570.759	\$5.75
---------	---------------

Soldering Tweezers

Heat resistant fiber grips and permanent tension self-locking blunt jaws are ideal for soldering operations or holding parts. Stainless steel, 6 1/2" long. India.

570.760 Straight	\$4.95
570.761 Curved	\$4.95

Self-Locking Tungsten Tip Tweezers

Handy self-locking tweezers have tungsten tips, which will not contaminate other metals, including platinum. Tips are replaceable. Unit fits nicely onto a third hand base. 7 3/4" long.

570.762	\$43.95
570.762.1 Replacement Tips	\$7.25 pr

Holder keeps rings aligned while soldering

Holds rings in perfect alignment while soldering together. No binding wire or tweezers needed. USA.

480.405	\$13.25
---------	----------------

**More
TWEEZERS, HEMOSTATS,
HOLDERS and STANDS
for soldering on pages 189 - 192.**

Tripods with Mesh Screen

Place over a bunsen burner or alcohol lamp, or used with heavy heating frame No.141.330 so that work can be heated from below while soldering or enameling. Heavy frame may also be used on a charcoal block or asbestos.

141.312	Tripod 6 1/2" Legs, Screen	\$19.45
141.315	Tripod 9" Legs, Screen	\$26.05
141.321*	Tripod only, with 9" legs	\$19.70
141.325	Mesh Screen only 6" x 6"	\$8.00
141.330	Heavy Frame 6" x 6"	\$8.50



141.330

141.312
141.315

HYDROFLUX Welder

The Ultimate Water Torch System

This unit is light, compact and self-contained for high performance, low maintenance, economical, trouble-free, oxide-free soldering. Exclusive features:

- Self-contained stainless steel gas dryer and filter, fluxing canister and drain for electrolyte.
- Flux compound level gauge. Distilled water gauge.
- Easy to set up and maintain. No exotic flux chemicals.
- Stainless steel check valve to prevent blow-back.
- Uses 30 - 18 gauge disposable needles.
- Finest pin point flame for repairing 1mm hollow rope chain up to a large flame for gents' rings.
- Can be worked with two torches for "40" gauge total needle combination.
- Concentrated electrolyte torch eliminates frequent recharging of solutions.
- Complete with flux, electrolyte chemicals, extra dryer filter and needles.
- Light weight torch handle for operator comfort. Shipping weight 40 lbs.



140.795	Hydroflux Water Torch System	\$1499.00
540.005	Colored Needle Tips, Set of Seven	\$8.75
540.005/15	Needle Tip 15 gauge Brown	\$1.50
540.005/18	Needle Tip 18 gauge Dark Green	\$1.50
540.005/19	Needle Tip 19 gauge Light Green	\$1.50
540.005/20	Needle Tip 20 gauge Pink	\$1.50
540.005/21	Needle Tip 21 gauge Purple	\$1.50
540.005/22	Needle Tip 22 gauge Blue	\$1.50
540.005/23	Needle Tip 23 gauge Orange	\$1.50
540.005/25	Needle Tip 25 gauge Red	\$1.50
540.005/26	Needle Tip 26 gauge Tan	\$1.50
540.005/30	Needle Tip 30 gauge Lilac	\$1.50
540.006	In-Line Filter	\$15.50
540.007	Cotton Dryer Filter for Hydroflux torch	\$12.50
540.008	Plastic Y Connector for Hydroflux Torch	\$7.75
540.009	Handpiece for Hydroflux	\$127.95
540.010	Pressure Switch for Krohn Water Torch	\$61.95
540.011*	Check Valve 1/4" for Krohn Water Torch	\$5.50
540.012	Gasket for Hydroflux Chamber 6 1/4" diam	\$29.75
540.013	Large "O" Ring for OKAI Handpiece Filter	\$2.75
540.014	Filter for Handle of OKAI Torch 140.795	\$12.50
540.015	"O" Ring for Handpiece On/Off for 140.795	\$3.75

140.795

If you need a *high temperature, clean, precise flame and safety*, this is the torch for you.

Conforms with fire code restrictions prohibiting LP, LN and compressed flammable gas cylinders.

Flux & Electrolyte Solutions for the Water Torch

540.001	OKAI Flux Solution for the water torch	\$25.95
540.002	OKAI Electrolyte Solution for the water torch	\$37.95
540.003	KROHN Flux Solution for the water torch	\$32.50
540.004	KROHN Electrolyte for the water torch	\$41.95

Cannot be shipped by air.

QUICK CHARGE Cordless Soldering Iron

Cordless soldering convenience you can depend on. High quality nickel cadmium batteries provide the power for up to 125 electronic joints from a fully charged iron. Recharge in 1/3 the time of regular irons. For electronic watch repair and soldering using Stay-Brite, TIX or soft solders.

- Complete recharge in 3 to 4 1/2 hours. Partial recharge in 1-2 hrs.
- Lightweight, balanced design. Complete portability.
- Soldering heat in 5 to 10 secs. Up to 125 solders per charge.
- Isolated tip design to eliminate electrical leaks and damage.
- Exclusive "lock off" switch for safety.
- Easily replaceable battery and worklight.
- Includes Iron, Recharge Stand, Fine Tip, Heavy Duty Tip and Instructions.

540.999	ISO-TIP Quick Charge Soldering Iron	\$57.25
540.995	Tip 7535-100, 5/32", 4.0mm	\$7.50
540.996	Tip 7545 Fine, 1.6mm	\$7.50
540.997	Tip 7546 Heavy Duty 3/16", 4.8mm	\$7.50
540.998	Tip 7566 Micro 1/64", 0.4mm	\$7.50
540.999/B	Replacement Battery for 540.999	\$20.50
540.990	Replacement Bulb for 540.999	\$4.25

ISO-TIP™



540.999

Cordless soldering convenience - get up to 125 solders per charge.



541.186



540.203



541.218 - 541.220



541.219

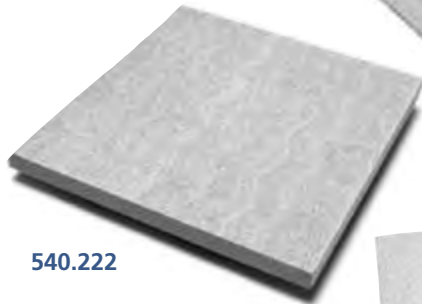

540.222



540.230



541.212

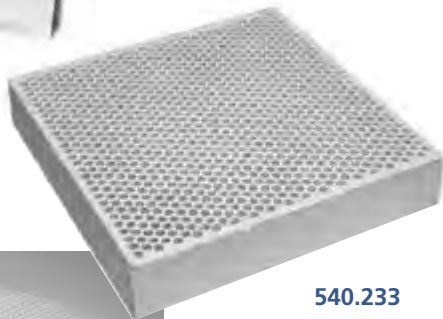

540.233



540.060

Magnesia Soldering Block

Soft, fire-proof material, into which work or pins can be easily pressed. Withstands temperatures up to 2000° F. 6" x 3" x 1/2".

541.186

\$6.30

HiTemp Block for Platinum

Hard, long lasting non-asbestos material withstands the high heat required for soldering platinum. Rubber feet. 6" x 6" x 1/2" thick.

540.203

\$31.50

Cordiorite Solder Boards

Non-asbestos. Withstands temperatures up to 2000° F. Rubber feet keep boards raised above bench.

541.218* 6" x 6" x 1/2"

\$18.90

541.220* 6" x 12" x 1/2"

\$19.95

Cordiorite Soldering Board with Grooves

Non-asbestos. Flat on one side, with grooves on the other, for holding shanks, chains, etc. Withstands temperatures up to 2000° F. Measures 7 1/2" x 7 1/4" x 7/8".

541.219

\$31.80

Transite Soldering Block

Protects bench during soldering. Measures 8" x 8" x 1/2".

540.222

\$22.95

Silquar Blocks

Hard, long lasting, non-asbestos material retains heat during soldering. Easily cleaned with water. Withstands up to 2000°F. Rubber feet. 1/2" thick.

540.230 2" x 12"

\$22.95

540.231 6" x 12"

\$15.25

540.232 6" x 6"

\$14.25

Asbestos-free Soldering Pads

Asbestos-free, light-weight pads are 1/2" thick and made so pins may be inserted to steady work. Two square sizes available.

541.212 12"

\$59.40

541.210 6"

\$31.95

Honey Comb Design Ceramic Soldering Blocks

Hard non-asbestos ceramic board with honeycomb perforations holds pins to keep work in place while soldering. Honeycomb helps heat to disperse evenly so you don't overheat and melt a part. Withstands temperatures up to 2000° F.

540.233 4" x 4" x 13/16"

\$20.95

541.215 3 3/4" x 5 1/2" x 1/2"

\$13.25

541.216 5 1/2" x 7 3/4" x 1/2"

\$20.30

Mini Honeycomb Soldering Board

Hold your work in place with our mini round honeycomb ceramic soldering board. Measuring 3" in diameter, each tray is packed two per box with 20 ceramic pins measuring 1.6mm.

540.060

\$10.50

540.061 Set of 20 Replacement Pins

\$3.25

Ceramic Ring Stand

Swivel base provides the exact position or angle desired. 6" ceramic rod is much cleaner than carbon and holds heat better. Clamp releases rod.

540.131	\$34.50
540.130* Replacement Carbon Rod	\$13.75
540.132 Replacement Ceramic Rod	\$8.50



540.131



540.128

Carbon Ring Stand

Holds rings, leaving both hands free. Mounted in fixed position on asbestos-free base. Length of rod is 6".

540.128 *	\$43.50
------------------	----------------

Cast Iron Ring Holder

Heavy cast iron base keeps holder and ring from moving during soldering. Prongs adjust for different size rings. 3" x 2". India.

480.700	\$7.50
----------------	---------------



480.700

Keep your stones cool while soldering

A jewelers' dream for resizing rings. Fill cup with cold water and submerge the stone and mounting while soldering the shank to keep the stone cool. Simple, but effective. Includes special sized locking tweezers slips on and off the post.

540.201	\$13.25
----------------	----------------



540.201

Rotating Non-Asbestos Soldering Table

Grooved work surface disk is 4 1/2" in diameter. Rotates on ball bearings, lazy-susan style, providing 360° access. Perfect for soldering small parts.

541.116*	\$38.85
541.117* Replacement disk	\$14.45



541.116

GROBET Charcoal Soldering Blocks

Charcoal glows under flame and reflects heat back into work, making the flame more efficient. Close-grained wood is converted by a special process. Chemically prepared for soldering. Easily punctured to hold work.

Size A = 3 1/2" x 2 1/4" x 1 1/2".

Size B = 4 1/4" x 3" x 1 1/2". Size C = 7" x 4" x 1 1/2"

Size	Box of 6	Price	Each	Price
A	541.151	\$49.95	541.152	\$10.35
B	541.161	\$79.95	541.162	\$16.30
C	541.171	\$135.00	541.172	\$32.35



541.151 -
541.172

Fume Extractor for a healthier work environment

Lead-free solder has created a healthier environment, but the more active fluxes required to be used with it give off more fumes. The Fume Extractor is the perfect solution to this smoky problem. Remove flux fumes from soldering workbench by drawing smoke through carbon-activated filter. Can process up to 1.37 cubic meters of air per minute. Adjustable stand allows for various angles. Quiet fan and ESD safe. Includes one replacement filter.

470.005	\$52.50
----------------	----------------



470.005

See pages
25 - 28
for more
air cleaners.

560.900



Add a little Firescoff™ to your work!

All-in-one Heat Shield, Flux & Firescale Preventer

Firescoff™ is a revolutionary spray ceramic coating that protects precious metals from heat oxidation and scale, acts as a flux, and comes off in just warm water or ultrasonic bath - no pickle required. 1 fl oz.

- Scale protection to melting temp.
- Reduces manufacturing steps.
- Better protection than boric acid.
- Multiple soldering without waiting.
- Promotes strong, void-free welds.
- No flux required.
- Fluoride-free.
- Alcohol-free, no carbon residue.
- Improves safety at the bench.
- Easy cleanup with warm water.
- Used by leading manufactures.

560.900 *Cannot be shipped by air*

\$12.50

541.750



541.722 - 541.742

Silver Clipped Solder

0.04" square flat pieces, Easy Flo grade. Ready to use. 1/4 oz. in bottle.

541.750

\$25.25

541.800



Silver Solder Wire

Wire Coils .031" 1 oz.

SKU	Grade	Melt Point °F	Price
541.722	Easy	1240	\$90.50
541.732	Medium	1275	\$69.95
541.742	Hard	1365	\$90.50

Bismuth Solder

Flows at low temperature and is recommended for pewter, silver plate, etc. Melting point 475° F. 1 oz. bar.

541.800

\$3.50

Lead Free Solder

Excellent for use in any soft solder applications. Does not contain any lead, antimony or zinc. Free flowing and produces a bright white finish.

541.811

\$69.95

Stay-Brite Solder

Melts at 430°F. Five Times Stronger Than Ordinary Solder. Flows free and smooth and solders most metals. Kit contains 1/2 oz. solder, 1/2 oz. flux.

540.452

\$19.95

540.452



541.811

Low Temperature Solder Paste

Excellent for use at low temperature of 430° F. Contains no lead or corrosive materials. Easy to use dispenser contains the proper amount of solder and flux. Five times as strong as ordinary solder. Will not tarnish.

541.801

\$12.15

541.801



TIX Solder

Hardest soft solder on earth. Melts at 275°F and has a holding power of 4300 PSI. Adheres to all ordinary solderable materials and works with gun, iron, torch or soldering machine. Stays white, does not tarnish. 3" sticks, 20 sticks per pack.

541.808

\$19.45

541.808



Silver Alloy Soldering Rods

Ideal for soldering non-precious and gold filled jewelry. Flux core eliminates the need for additional flux for cleaning agents. 6" long x 1/32" diameter. Rods provide a strong, permanent bond with a gold-tone finish. Each rod contains .129 dwt of silver. Melting temperature 1275° F.

541.755 Pack of 4 Rods

\$37.35

541.756* Pack of 12 Rods

\$99.00

541.755
541.756

Soldering Protection for Jewels

KOOL-JOOL®

Protects jewels from heat while soldering. No need to remove jewels from settings (except opals). If flame is used for soldering, the jewel will stay cool. Rinses off in plain water. 8 oz jar

541.468 **\$10.50**

Cannot be shipped by air.

VIGOR® Heat Shield Paste

Protects components under direct 5000°F flame. Not necessary to remove stone before soldering. Prevents oxidation, odorless and non-toxic. Good for dozens of jobs. Washes off with water.

541.448 1 lb Jar *Cannot be shipped by air.* **\$16.75**

541.449 2 oz Tube **\$9.25**

Insulating Paste

Apply to jewelry and stones while soldering to protect areas that may be affected by heat. No need to remove diamonds from rings.

540.663 **\$9.50**

Cannot be shipped by air.

Therma-Guard Protective Blanket

Silquar ceramic material forms a protective blanket around any stone or jewel while adjacent metal parts being soldered or heated. Resists temperatures up to 2000°F. Odorless, non-toxic and easy to use. 2 oz jar is good for hundreds of jobs because it's reusable.

541.469 **\$14.00**

Water Torch Solutions

OKAI Flux Solution for the Water Torch

OKAI Flux, 32 fl.oz.

540.001 **\$25.95**

Cannot be shipped by air.

OKAI Electrolyte Solution

For use with the Water Torch System. 32 fl.oz.

540.002 **\$37.95**

Cannot be shipped by air.

Krohn Flux Solution for the Water Torch

Fluxed Flame Methanol/ Acetone/ Boric Acid Solution is ready to use. This formulation provides for virtually oxide free soldering on karat gold. 32 fl.oz.

540.003 **\$32.50**

Cannot be shipped by air.

Krohn Electrolyte for the Water Torch

Krohn Electrolyte Solution for the fluxed flame water torch system. Ready to use. 16 fl.oz.

540.004 **\$41.95**

Cannot be shipped by air.



541.468



541.448



541.449



540.663



541.469



540.001



540.002



540.003



540.004



540.442*



541.0341



540.935



541.462



541.460



540.416



541.472



541.415



540.401



540.300



540.301

Dandix Paste Flux

For use in low temperature brazing and silver soldering ferrous and non-ferrous metals. Begins to dissolve oxides at 800°F is fluid- active between 1100 and 1600 F. Contains no fluoride.

541.440	1½ oz	\$7.95
540.442*	8 oz	\$13.25
541.444*	16 oz	\$25.20

VIGOR® Creamy Silver Brazing Flux

Spreads quickly and wets the surface completely so alloys flow better. Protects from oxidation while heating and retards discoloration of brazed area. Working temperature range 1100°-1350°F. Remove excess flux with hot water. No waste or loss due to drying, simply add water until creamy.

541.0340*	2 oz	\$5.25
541.0341	8 oz	\$14.65

Lloyd's No.7 Silver Brazing Flux

A quick and clean, creamy paste flux for silver brazing and hard soldering. For use with all jewelry metals including silver, gold, copper, nickel and platinum. Replaces Kwikflux. 12 oz.

540.935		\$10.25
---------	--	---------

TIX Flux®

A non-corrosive flux, harmless to hands or clothing. Washes off with water even after drying. Works with any soft solder. 1/2 oz.

541.460		\$6.25
---------	--	--------

TIX Anti-Flux®

Prevents solder from flowing to unwanted areas. Brushes easily.

541.462		\$6.60
---------	--	--------

Stop Flow Anti-Flux

Prevents solder from flowing to unwanted areas.

541.472	1/4 oz	\$6.95
541.473	32 ozs	\$135.95

Aqui Flux in a handy spray bottle

It's the tried-and-true jeweler's hard soldering flux. Yellow-green and self-pickling. It is the best in water-based fluxes. Well-mixed to eliminate suspension. And it comes in a spray bottle making Aqui Flux super handy to use! 8 ounces.

540.401		\$5.25
---------	--	--------

Flux Bottle with Stainless Steel Spout

Handy for depositing flux or any liquid right where you want it. Steel spout is 1½" long and has a plastic cover when not in use. Just squeeze and a small amount comes out. Holds 2 ozs.

540.416		\$4.95
---------	--	--------

Flux/Fluid Dispenser Pumps

Handy for depositing just the right amount of flux or any liquid right where you want it. Compact polyethylene bottle with stainless steel pump-action lid. Three sizes: 4oz, 120ml and 180ml.

541.415	4 oz Dispenser	\$31.00
540.300	120ml Genuine BERGEON 6994-120 Dispenser	\$34.95
540.301	180ml Genuine BERGEON 6994-180 Dispenser	\$34.95

Cas-Ker Gold Repair Solder - Cadmium free. One Dwt. sheets.
Yellow or White.

Flow	X-Easy	Easy	Medium	Hard
10 Yellow	-----	16-102-02-3	16-102-03-3	16-102-04-3
10 White	-----	16-102-02-4	16-102-03-4	16-102-04-4
14 Yellow	16-103-01-1	16-103-02-1	16-103-03-1	16-103-04-1
14 White	-----	16-103-02-2	16-103-03-2	16-103-04-2
18 Yellow	-----	16-104-02-5	-----	16-104-04-5
18 White	-----	16-104-02-6	-----	16-104-04-6

Platinum Repair Solder - May be used for Palladium. Cadmium free.
One Dwt. sheets.

Number	Flow	
16-122-12-16	1200° Medium	<i>Prices fluctuate with the platinum market. Please call for current prices.</i>
16-122-14-16	1400° Extra Hard	
16-122-15-16	1500° Welding	
16-122-17-16	1700° Seamless	

Noble Solder - Contains Cadmium.

Easy Yellow	Quality	Easy White	Quality	Hard Yellow	Quality
16-105-02-3	10 Yellow	16-105-02-4	10 White	16-106-04-1	14 Yellow
16-106-02-1	14 Yellow	16-106-02-2	14 White		
16-107-02-5	18 Yellow	16-107-02-6	18 White		

Clipped Gold Solder - Cadmium free. 14Yellow or White Easy or Med.

Easy	Medium	Quality	Price
16-120-02-1	16-120-03-1	14 Yellow	Call
16-120-02-2	16-120-03-2	14 White	Call

Gold Solder Paste

Easy flow. Cadmium free. One Dwt syringe premixed with flux. Includes two sizes of tips. 10K, 14K, 18K Plumb Gold.

Easy	Quality	Easy	Quality	Price
16-110-3	10K Yellow	16-110-4	10K White	Call
16-113-1	14K Yellow	16-113-2	14K White	Call
16-114-5	18K Yellow			Call

Silver Solder Paste

One ounce silver solder paste with flux. Cadmium free.

540.832	\$13.95
540.940 3-Pack of Soft, Medium & Hard, 1/4 oz each	\$39.95

Phos-Copper & KB430 Low Silver Solder Paste

Krohn Phos-Copper flows at 1325°F. Light Brassy color for copper, brass, bronze and mixed metal like silver to brass, and stainless to brass or gold. 1/2 oz.

540.836 **\$6.25**

Krohn KB430 Low Silver paste flows at 430°F. White color for nickel, German Silver, stainless steel, silver, brass and bronze. Both are cadmium-free. 1/2 oz.

540.835 **\$8.50**

Silver Solder Sheet

1/4 ounce sheets available in three grades. Jeweler's prices per 1/4 oz.

540.701 Easy 1240°F	\$9.50
540.702 Medium 1275°F	\$9.95
541.703 Hard 1365°F	\$9.95
540.950 3-Pack, one each Easy, Medium & Hard	\$26.50

YR Repair Solder

For repairing costume jewelry. Melts at 1125°F. Flows at 1145°F

540.829 **\$4.50**

Casting Alloy

Mix with bullion to make 10K, 14K or 18K gold. Roll, stamp or cast. Contains no gold. Casting temperature 1950° Flash temperature 1200°

16-121-1 Yellow	\$11.75 oz
16-121-2 White	\$10.95 oz

Prices fluctuate with the gold market. Please call for current prices.



16-122-12-16



16-106-02-1



16-120-03-2



16-110-3



540.832



540.702



540.829



16-121-11

541.402 -
541.410*



541.423



541.522



541.501



541.505*



540.901



541.252



540.600



541.470



560.901

Battern's® Self Pickling Hard Soldering Flux

Makes hard soldering as easy as soft soldering. Use on gold, silver, platinum and other metals with high melting points. Preserves temper and color of metal and the adhesive qualities of this liquid flux hold solder in place.

541.402	3 oz	\$6.30
541.404	8 oz	\$7.70
541.406	16 oz	\$11.95
541.408	32 oz	\$22.10
541.410*	128 oz (shipping weight 9 lbs.)	\$47.75

Cannot be shipped by air.

Griffith Solder Flux

541.423	for Soft Solder 4 oz	\$9.05
541.513	Self-Pickling for Hard Solder 16 oz	\$11.60

Magic Cast Boric Acid Powder

Use as an anti-oxidizer during soldering or in making flux. 16 oz. *Cannot be shipped by air.*

541.522		\$9.95
---------	--	--------

Prip's Flux

Excellent flux for soldering jewelry. Fluoride-free. Also used for fire coat protection. Prevents formation of fire scale. Four sizes.

541.501	4 oz	\$5.85
541.503*	16 oz	\$11.95
541.505*	1 Gallon	\$50.75

Cannot be shipped by air.

Blue Flux-1®

Gas corrective flux for soldering and annealing precious metals for jewelers. Use as you would standard alcohol based flux. Concentrated slurry form of flux comes in a gallon jug. Simply fill with alcohol before use. Before alcohol is added flux can be safely and inexpensively stored and transported. *Cannot be shipped by air.*

540.901		\$12.25
---------	--	---------

Borax

Prepared borax for making flux for soldering jewelry. Dissolves easily when rubbed on borax slate. 4 oz. cone.

541.252		\$9.75
---------	--	--------

Solder Prints™ makes solder joints appear

Simply apply liquid Solder Prints to any area of jewelry where you suspect there are solder joints. Joints will appear as a darker line if present. Remove any joint discoloration by polishing. Safe on gold and silver alloys. Spreads easily with a brush or plastic applicator. 1/5 oz. bottle. *Cannot be shipped by air.*

540.600		\$13.25
---------	--	---------

PRO-CRAFT® Yellow Ochre

When this powder is mixed with water or alcohol, it can be used to prevent the flow of solder to unwanted areas, such as a previously soldered joint or the moving parts of a catch. 1/2 lb.

541.470		\$12.25
---------	--	---------

OKAI Dispensable Flux Syringe

Concentrated brazing flux for use on gold, silver and most non-precious metals. Tends to stay in place where it is applied, allowing excellent control over flux placement. Use very little - keeps metal clean. Also holds solder chips in a joint. 2 dwt

560.901		\$4.25 ea 6@ \$3.75 ea
---------	--	------------------------

Electric Pickling

Pickling is the immersion of metals in an acid solution, for the purpose of removing surface fire scale and oxides caused by heating, annealing, casting, soldering, etc. Sulfuric acid is sometimes used, but substitutes are shown. The pickle solution works better if heated to a temperature of approximately 125° F.

Little Dipper Pickle Pot

American made by Rival® with a stoneware bowl. They call it a crock pot, but it's the best and most economical pickle pot available. It's 16 ounce capacity makes it an ideal size for jewelry items. Keeps the solution at an even temperature and prevents it from boiling away. 210°F maximum heat. One Year Warranty.

450.300 **\$27.50**



Electric Pickler

Automatically keeps solution at the right temperature and prevents it from boiling away. Plastic basket is included for holding articles in solution. 115 Volt.

Number	Capacity	Diameter	Height	Price
451.306*	12 oz.	5"	5¾"	\$156.00

Replacement Baskets

No.	Capacity	Price
451.312	1½ quart	\$72.00
451.314	1 pint	\$26.05
451.315	12 oz.	\$24.80



Griffith Pickle Safe

Dry granular acid pickling compound. Safer than sulfuric acid for cleaning and pickling non-ferrous metals. 2.5 lbs.

451.136 **\$11.05**

Cannot be shipped by air.



451.136

Sparex Pickle

Dry granular acid compound specially made for pickling, the cleaning and removing of surface oxidation and scale from copper and silver. Non-flammable and non-explosive.

450.127 2½ lbs. makes 1 gallon **\$7.25**

450.128 10oz makes 1 quart **\$4.25**

Cannot be shipped by air.



450.127



450.128

Double Burner Electric Hot Plate

Three ring burner, tubular elements and infinite control switches. Chrome top and white trim. 120 volt AC, 50/60 Hz, with three-prong grounded cord. UL listed. One year warranty. Measures 17" x 8½" x 3¼". 13 Amps, 1400 Watts. Shipping weight 6 lbs.

451.712* **\$94.50**



451.712*

Solder, Cast & Clean with "Magic" Results



540.299



450.125



220.655



540.506



220.668

"Magic Boric" Solder Dip

*No Fluxing - No Alcohol - No Burn Off
Cut Your Soldering Time in Half
Just Dip & Solder*

Built-in Flux cuts your soldering time in half. Just dip and solder gold, silver and platinum. One step soldering - not three. 16 oz.

- Safe, fast, long lasting, non-flammable.
- No alcohol means no flaming up. No burn off, no waiting.

540.299

\$11.95

Cannot be shipped by air.

"Magic Pickle" Compound

Preserves Metal - Cleans Fire Scale

Sodium Bisulfate for pickling Gold and Silver. Add a tablespoon to your pickle pot. Let soak for 5 to 10 minutes. Rinse with water. Use copper tweezers. 10 oz.

450.125

\$9.50

Cannot be shipped by air.

"Magic Green" Concentrate

*Strong - Fast - Ammonia Free
Long Lasting - Will Not Evaporate
Powder Means Lower Shipping Cost*

Ultra-fast space age ultrasonic concentrate.

- Cleans all precious metals, diamonds, precious, semi-precious stones and CZ's. Use 1 oz to gallon of water.
- No Ammonia, fresh scent.
- Removes buffing compound and attacks tripoli instantly.

220.656 10 lbs makes 160 Gallons

\$75.00

220.655 32 oz makes 32 Gallons

\$19.95

Cannot be shipped by air.

"Black Magic" Non-Acid Pickle

*Safe - Fast - Long Lasting
No More Acid on the Bench
Will Not Harm Clothes or Hands*

Non-Acid Pickling Compound. Ready to use. Pour in pickle pot and heat. One gallon.

- No toxic fumes or corrosion on bench. Biodegradable.
- Safely and effectively removes boric acid, flux and copper oxides from gold, silver, copper, most non-ferrous metals.
- Copper tweezers are unnecessary. Use steel tweezers.

540.506

\$29.95

Cannot be shipped by air.

Magic Luster Super Ultrasonic Cleaner Concentrate

Super Fast - Eats Rouge & Tripoli

Industrial strength for gold and silver. Biodegradable, no ammonia. Just add water. 1 gallon concentrate makes 40 gallons of solution.

220.668

\$20.50

PEPETools Digital Pen Plating System

Impulse power makes it easy to plate difficult solutions such as black or blue rhodium.

- Stable voltage. Automatic dual voltage (115V/220V).
- Quick connect/disconnect.

System Includes:

- 1 professional plating pen
- 3 empty plating jars with twist off lids to avoid spills
- 3 double ended X-fine/Bullet Felt Tips
- 1 alligator clip
- 1 Switching Power supply with US and European Plugs
- 1 wire holder

450.505 **\$219.95**

450.505C Replacement Power Cord for Pen Plater **\$8.50**



PEPETools Plating Pens

Replacement Pens for use with any plating machine.

450.385 Pink Gold Base/ Pink **\$49.95**

450.386 Yellow Gold Base/Yellow **\$49.95**

450.387 Rhodium Base/White **\$49.95**

450.388* Black Rhodium Base/Green **\$49.95**

450.380 Felt Tips Set of 3 each Bullet, Chisel, X-Fine **\$3.95**

450.381 Felt Tip Bullet 3 pack **\$1.50/pk of 3**

450.383 Felt Tip X-Fine 3 pack **\$1.50/pk of 3**



450.380
-450.388

Plating Pen "Wizard Pro"

Wizard Pro Rechargeable Plating Pen features LCD display and 12v charger. Comes in nylon zip case with USB connector. Great for touch ups and portable repair work.

450.105 **\$179.95**



450.105

Tripour Disposable Beakers

Cost-effective polypropylene plastic beakers have three dripless pouring spouts and graduated markings. Use with acids, alkalis, and solvents. Temperature safe to 250 degrees. Pack of 25.

450.635 1000ml **\$19.00**

450.636 800ml **\$14.00**

450.635
450.636



Plating Guide

The trusted professionals at Grobet USA cover step-by-step plating procedures in an easy-to-learn technique.

621.01215 **\$6.65**

Pyrex Beakers

Ideal containers for plating solutions. Covers sold separately.

451.640 600 ml **\$15.25**

451.641 1000 ml **\$26.95**

Covers for Beakers

450.644 600 ml **\$7.60**

450.645 1000 ml **\$8.35**

Stainless Steel Beakers

Can be used as the anode needed for electro-stripping and gold plating. Just attach your lead wire to the lip of the beaker.

451.642 600 ml **\$72.00**

451.643* 1200 ml **\$119.00**



621.01215

450.644
450.645

450.640
450.641

451.642
451.643*



450.402 PEN PLATER KIT
450.404 PEN PLATER ONLY



450.389 - 450.648



450.110



450.125



450.692

Disposable Pen for easy, affordable plating

Self Contained - Self Adjusting - No Rectifier Needed - Easy to Use
Our Disposable Pen lets you plate 300 to 350 rings . . . anywhere. The self contained marker size pen is compact, easy to use, and self adjusting. Battery operated - no need for rectifier. Use with pen plating solutions, below. Made in USA.

450.402 Pen Plater Kit w/ any 5 Gold Solutions*	\$279.00
450.404 Pen Plater Only	\$39.95
450.409 Rhodium Pen Plater w/ Rhodium solution	\$79.95

*Kit includes your choice of 5 Gold Solutions Only
(Rhodium and Black Rhodium are not available with Kit 450.402.)

Pen Pals Pen Plating Solutions and Tips

Specially formulated, state-of-the-art pen plating solutions designed to provide quality results. Super Hard solutions give a longer lasting plate and a brighter finish. Use with 450.404 Pen Plater. One ounce in nalgene jar. No hazardous shipping charges. *Cannot be shipped by air.*

450.389 14K Gold	\$49.95
450.390 18K Gold	\$49.95
450.391 18K Green Gold	\$49.95
450.392 24K Gold	\$49.95
450.393 Rose Gold	\$49.95
450.394 Super Hard 14K Gold	\$49.95
450.395 Super Hard 18K Gold	\$49.95
450.396 18K Green Super Hard Gold	\$49.95
450.397 24K Super Hard Gold	\$49.95
450.399 Rhodium	\$45.00
450.399B Black Rhodium	\$56.00
450.648 Black Rhodium 1/2 gram	\$126.00
451.405 Felt Tips, set of five	\$5.25

Magic Pickle Compound

Sodium Bisulfate for pickling Gold and Silver. Preserves metal. Cleans fire scale. Add a table spoon to your pickle pot. Let soak for 5 to 10 minutes. Rinse with water. 10 oz.

450.125	\$9.50
----------------	---------------

Cannot be shipped by air.

KROHN Heavy Duty ElectroCleaner

Ready-to-use solution formulated for electrocleaning. Especially useful for cleaning castings and articles to be plated. The solution removes all grease, finger prints, polishing compounds, etc. Heat to 180°F in a glass container. Connect a stainless steel anode and make the article to be electrocleaned the cathode. One quart.

450.110	\$14.25
----------------	----------------

Cannot be shipped by air.

Krohn TIVACLEAN all purpose Cleaning Concentrate

TIVACLEAN is an all purpose cleaning concentrate used to clean both metal and plastic. Use TIVACLEAN on finished products, when stripping is not necessary. Articles to be plated must be thoroughly cleaned before plating. Use Krohn TIVACLEAN to insure the removal of all polishing rouge, oil, grease, finger prints, etc. Use it hot or cold in ultrasonic cleaning tanks or electrocleaning. 1 lb. Dissolve 8ozs. powder in 1 gallon of water.

450.692	\$9.95
----------------	---------------

Cannot be shipped by air.

PRO-CRAFT® Anodes

The base metal portion of these anodes measures 1/2"W x 2"L in varying thicknesses. Attached to a stainless steel stem which can be bent to hang onto edge of beaker. Platinized Titanium for rhodium electroplating. Stainless steel anode may be used with all gold solutions.

451.592	Copper 6" x 1"	\$8.50
451.597	24K Gold 1" x 1"	\$89.95
451.598	Nickel 6" x 1"	\$13.20
451.600	Platinized Titanium T-Bar 10¼" x 4"	\$79.95
451.601*	Platinized Titanium Mesh 4" x 1" for Rhodium	\$79.95
451.602	Silver 6" x 1/2"	\$98.20
450.604	Stainless Steel use in Electro-Clean Solutions 6x1"	\$7.50

* Special Order. Please allow 5-7 business days for delivery.

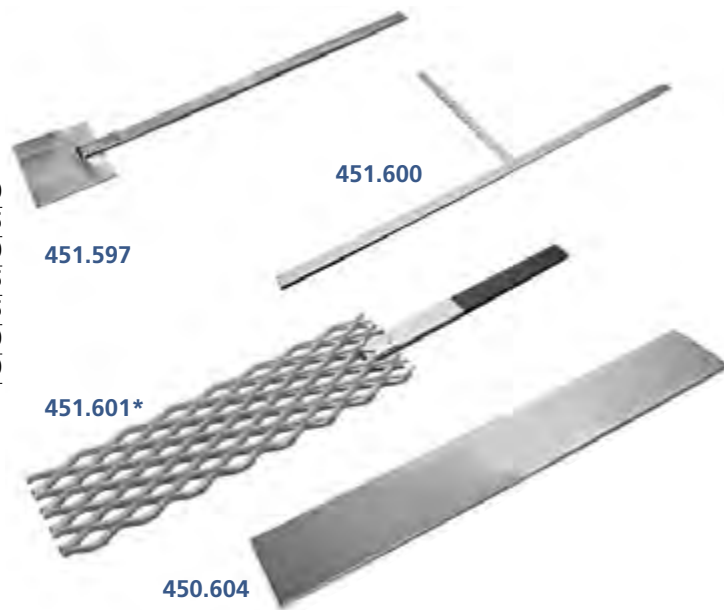

Liver of Sulphur Extended Life Gel

XL Gel is formulated for extended shelf life, versatility and convenience. XL's shelf life is many times that of dry liver of sulphur. Apply patina to silver, copper, bronze, brass, metal leaf and metal clay. May be dissolve in hot water or used in its ready form by brushing it onto objects. Non-flammable, contains no acid. 4 fl. oz. Cannot be shipped by air.

451.690 **\$17.95**

Background Antique for Jewelry

For highlighting or subtle dark background effects. Gives a dark, dull antique finish to class rings, or any other jewelry. Adheres to any metal, dries in minutes. Resistant to wear, needs no lacquer.

Antique Solution**

451.0130	Black	\$15.25
451.0132	Brown	\$21.00

Aul Solvent

Removes background color from high spot surfaces.

451.0135 **\$14.95**

Solution with Aul Solvent**

451.0230	Black	\$20.95
451.0231*	Green	\$15.95
451.0232	Brown	\$28.95
451.0233*	Set of all three colors	\$39.95

**Subject to DOT Federal Regulations. Cannot be shipped by air.



PRO-CRAFT® Immersion Thermometer

For determining solution temperature within range 0-230° F.

451.696 **\$52.55**



SUPERBRITE™ Rhodium Plating Solution

The brightest, whitest, most forgiving formulation ever! SUPERBRITE™ Rhodium Plating Solution Kit from Cohler Enterprises consists of 1/2 gram rhodium bath concentrate and 1/2 pint distilled water. Simply add the water to the concentrate and mix. Plate at room temperature in a variety of plating ranges without burning the pieces or dulling the brightness. Both pen and bath SUPERBRITE™ solutions are equally bright. Jewelers who have been looking for a brighter rhodium now have a complete product line that will give them that "WOW" effect! Small package allows us to ship rhodium plating solution directly to you with No Hazardous Materials Shipping Fee. Cannot be shipped by air. Rhodium price subject to change with market fluctuations.

450.638 **CALL FOR PRICE**

*Rhodium price subject to change with market fluctuations. Please call for current price before ordering: 1-800-487-0408.





Clean Earth™ Gold Plating Solutions

Produce a uniform gold color. Use with stainless steel or pure gold anode. Plate with the solution heated to 140°F at 3 to 4 volts for 30 to 45 seconds. Plating time or solution temperature will affect color.

451.212	14K One Quart	\$175.00
451.213*	14K One Gallon	\$1195.55
451.214*	18K One Quart	\$175.00
451.215*	18K One Gallon	\$1193.40
451.216*	24K One Quart	\$373.60
451.217*	24K One Gallon	\$1193.40

Clean Earth™ Silver Free

Produces a uniform silver plate. Use with a stainless steel or pure silver anode. Plate with solution at room temperature at 1.4 to 1.8 volts for 15 to 90 seconds. The finish will reflect the surface of the underplate; shiny silver over shiny metals and matte silver over a dull surface. One quart.

451.220		\$73.50
----------------	--	----------------

Clean Earth™ Strip-Free

Used to strip gold plating. Use with a stainless steel anode. Reverse plate with the solution heated to 120°F to 150°F at 3 to 6 volts for 30 to 90 seconds. One quart.

451.218		\$33.10
----------------	--	----------------

Clean Earth™ Copper Primer

Pre-plate to cover difficult to plate tin, lead, zinc die-cast metals, etc. An excellent base for nickel plating. Use with a pure copper anode. Plate with solution at 130°F at 1 to 2 volts for 2 to 5 minutes. One quart.

451.206		\$53.10
----------------	--	----------------

Clean Earth Solutions cannot be shipped by air.

Clean Earth™ Plating Solutions

All Clean Earth™ plating solutions are cyanide free. They are ecologically safer than standard plating solutions yet plate uniformly and produce a hard, durable finish. The solutions are easy to use and produce rich colors.

Clean Earth™ Copper Mirror

Air bubble agitation produces superior uniformity and shine for a bright copper finish. Use with a pure copper anode. Plate with solution at room temperature at 2 to 3 volts for 2 to 10 minutes. Electroform at 1 to 1.3 volts for 30 minutes to 5 hours. 1 qt.

451.208		\$47.15
----------------	--	----------------

Clean Earth™ Nickel Mirror

Adds a decorative brilliance and a white mirror shine to dull finishes. Best if used over Copper Mirror. An excellent base for rhodium, gold or silver plating. Use with a pure nickel anode. Plate with solution at 140°F at 2 to 4 volts for 2 to 10 minutes. 1qt.

451.210		\$41.25
----------------	--	----------------

Clean Earth™ Black Free

Use to achieve an antique finish. After article is plated with Black Free, highlights are relieved by polishing. Use with a stainless steel anode. Plate with solution at 120°F at 3-6 volts for 30-90 seconds. One quart.

451.226*		\$47.25
-----------------	--	----------------

Clean Earth™ Electrocleaner

A quick and effective method of cleaning objects prior to plating. The cleaning process uses an electrolytic bath, similar to plating operations. Use with stainless steel anode. Clean with the solution heated from 120°F to 160°F at 2 to 6 volts. 2 lb. makes 8 gallons.

451.202		\$24.95
----------------	--	----------------

Clean Earth™ Activator

This powerful acid is mixed with water to produce a mild solution for etching, brightening and cleaning. Use to clean and activate parts to assure strong metallic bonding throughout the subsequent plating process. Use at room temperature for 30 to 60 seconds. Not used with a rectifier. 2 lb. makes 8 gallons.

451.204		\$24.95
----------------	--	----------------



450.320

Stop-Off Plating Mask Pen

Use the Stop-Off Pen to mask those areas on jewelry you do not want to be plated. Extra fine tip makes it easy to mask off precisely. Mask liquid is readily removed with acetone, nail polish remover, etc. Long lasting and disposable.

450.320		\$9.50
----------------	--	---------------

Simple and easy to use, even beginners will be producing professional work in a short time

Ceramit™ Enameling Set

Low temperature curing, hard enamel. Requires only 200° F (93° C) for one hour and the result is a ceramic-like surface, which resembles kiln fired enamels in both appearance and physical properties.

- Two-part, liquid system, mix catalyst and color in a 2-to-1 proportion.
- Brush on, spray or apply with a spatula or squeeze bottle.
- Cure in ordinary electric kitchen oven, by infra-red lamps or by forced air blowers.
- Hardness of 60-75 on the Sward scale (compared to kiln-fired enamel 65-80, which requires 1500° F.
- Adheres to metals, wood, plastics, ceramics, etc. and can be stoned and polished.
- 30 vibrant colors available which can be mixed to obtain an infinite variety of shades.
- Applies a single coat build up in layers for unusual finishes.
- Set includes sufficient catalyst along with 14 colors in 1/2 oz. bottles: opaque; red, orange, yellow, jade green, turquoise, black, super white, and transparent; red, orange, yellow, green, blue, brown and clear.



451.800

Ceramit™ Enameling Set

451.800 8 oz. **\$99.95**

Ceramit™ Catalyst Refills

451.880 8 oz. **\$16.50**

451.881* 1 pt. **\$38.40**

451.882* 1 qt. **\$56.95**

Ceramic Thinner

451.884* 1 pt. can **\$37.60**

Cannot be shipped by air.

Replacement Ceramit™ Colors

Individual 2oz bottles can be ordered by product numbers listed with colors. See prices by colors.

Opaque Colors

Black	451.801	\$12.10
Pearl	451.802	\$12.10
Super White	451.803	\$12.10
Iridescent Pink	451.805	\$12.10
Chinese Red	451.807	\$12.10
Red	451.809	\$12.10
Violet	451.810*	\$10.75
Brown	451.811	\$12.10
Cocoa	451.812*	\$12.10
Orange	451.813*	\$12.10
Yellow	451.816	\$12.10
Butterfly	451.817*	\$12.10
Olive Green	451.818*	\$12.10
Jade Green	451.819	\$12.10
Green	451.821	\$12.10
Sky Blue	451.823	\$12.10
Turquoise	451.824	\$12.10

Opaque Colors, cont.

Israeli Blue	451.825*	\$12.10
Blue	451.826	\$12.10

Fluorescent Colors

Red	451.861	\$12.10
Green	451.864*	\$12.10
Blue	451.866*	\$12.10

Transparent Colors

Red	451.841*	\$12.10
Violet	451.842*	\$12.10
Brown	451.843*	\$12.10
Orange	451.844*	\$12.10
Yellow	451.845	\$12.10
Green	451.846*	\$12.10
Blue	451.847	\$12.10
Clear	451.848	\$12.10

Ceramit products cannot be shipped by air.

U-NAMEL®



U-NAMEL® UV Cured Enamel System

An easy method of enameling utilizing fast curing ultraviolet sensitive material.

- U-NAMEL® can be inlaid into precious or non-precious metal, glass, plastic, ceramic, enamel or U-NAMEL®.
- Adheres to flat surfaces. Cures in 1-2 minutes.
- Seven easy to mix colors that won't fade.
- Scratch & wear resistant. Won't chip, flake, peel or shrink.
- Can be layered to produce cabochons.
- Easy to drill, grind, polish, carve and sand.
- Can be turned at high speed.
- Non-hazardous, can be shipped by air.

Complete Kit Includes:

- Seven 10cc colors: black, white, red, blue, yellow, green and clear.
- Mixing / Application Tools.
- UV Curing Light (requires 4-AA batteries, not included).
- UV Protective Glasses.

130.910 U-NAMEL® Kit	\$89.95
130.910.BK Replacement Black U-NAMEL® 6 gram Jar	\$16.95
130.911 Replacement Clear 15 gram Jar	\$23.50
130.912 Black Dye Concentrate 3cc Syringe Refill	\$14.95
130.913 Blue Dye Concentrate 3cc Syringe Refill	\$14.95
130.914 White Dye Concentrate 3cc Syringe Refill	\$14.95
130.915 Yellow Dye Concentrate 3cc Syringe Refill	\$14.95
130.916 Red Dye Concentrate 3cc Syringe Refill	\$14.95
130.920 AC Adaptor for UV Light	\$18.50
130.921 UV Curing Light - Battery Operated	\$28.50



210.270

ARBE
Made in USA



210.260

Electric Wax Carving Tools

ARBE Precision Wax Carving Tool

This wax tool from ARBE features:

- "Ultrasensitive" precise rheostat provides accurate temperature control to over 800°F.
- Heavy duty handpiece with removable tip.
- Brushed aluminum cabinet ends.
- Integrated handpiece holder.
- Includes one tip, three styles available.
- Made in USA.

210.270	Carving Tool with one Blue Tip	\$149.95
210.270B	Blue Tip (Round Nose w/ slight bend)	\$12.75
210.270R	Red Tip (Broad Spatula)	\$12.75
210.270Y	Yellow Tip (Bent)	\$12.75

MAX WAX - The Ultimate Cordless Wax Pen Gives You Better Control

Ideal for design work or for everyday bench jobs. Form beads and details, whisk away flares and spray, and repair floaters and accidents. The tip is specially designed to transfer wax to models. Other features and benefits include:

- Instant heat up to 850°F with finger pressure control.
- Battery caps mean no contact problems.
- Powered by one AA battery, included.

210.260	Max Wax Pen w/1 Tip	\$27.50
210.261	Set of 3 Pen Tips	\$14.95

Casting Equipment

NeyCraft Burnout Furnace

Capable of heating to 1000°F (538°C) in 15 minutes. Maximum operating temp. 2012°F (1100°C). Chamber is 9" x 9" x 6½". Energy efficient insulation. Four heavy duty wall heat elements are embedded for safety and even temperature distribution. Temperature and heat rate are set by reliable infinite control system. Chamber temperature is indicated by an accurate dual scale pyrometer. Rugged steel cabinet is welded and coated inside and out with heat resistant enamel. Exterior temperature always within safe limits. Made in USA.

220.127* **\$1100.00**

Centrifugal Casting Machine

Runs quietly on a dual ball bearing race. Can be portable or permanently mounted. Insta-balance mechanism is quick and simple, from the smallest flask up to 4 x 4". No external shield required. Unique rotating safety shell protects the operator from hazard inherent in centrifugal casting. Wind-lock mechanism keeps operator's hands clear of the centrifuge. Includes one each: 2" and 3" sprue base, flask, No.702 crucible and tongs.

220.360* **\$850.00**



220.127*



220.360

PRO-CRAFT® 10 lb. Investment Scale

Accurate, yet economical, scale weighs in 2 oz. increments. Easy to read red and black numerals on 4" dial indicate weight, as well as water/investment ratios. Includes scoop.

211.773	\$31.10
211.772* Replacement Scoop	\$4.20



211.773

211.731*

Investment Scoop

Plastic scoop for handling dry investment. 4¾" x 8½" x 3".

211.731*	\$10.30
-----------------	----------------

Burnout Tray

Neycraft burnout tray has grooves for wax. 4" x 4".

220.100	\$31.95
----------------	----------------

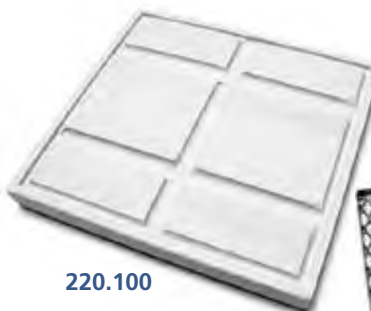

220.100

Wax Drip Trays

Stainless steel trays protect the floor of your burnout oven, while providing proper support for your flasks. They increase the life of heating elements, and are a must when using plasticized wax.

221.119* 12" x 12" x 3/4"	\$65.00
221.11901 7½" x 7½" x 3/4"	\$56.05

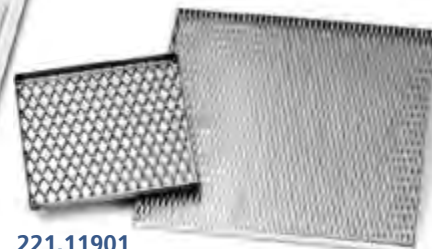

221.11901

221.119*

Borax Flux

Controls oxidation during the melting process. 8 oz. can.

221.820	\$7.75
----------------	---------------



210.725



221.820

R&R Astro-Vest for Platinum

Investment for platinum, steel and other ferrous applications. This phosphate bonded investment is prepared simply by adding water to the investment. 50 lb pail.

210.725	\$114.95
----------------	-----------------

R&R Ultra-Vest - The World's Most Widely Used Jewelry Investment Powder

For the jewelry caster, Ultra-Vest offers smooth, defect-free castings of gold, silver and other non-ferrous alloys. Demanding craftsmen trust the Ransom & Randolph brand. Batch to batch, consistency stands out. Superior quality, exceptional performance, less waste, greater productivity and superior value makes R&R Ultra-Vest the most widely known jewelry investment in the world. R&R is proud to have set the gold standard for jewelry casters. Dedicated to supporting jewelers with continuous quality improvement, research and testing, Ransom & Randolph's production facilities are unmatched in the industry. 50 lb. box. F.O.B. Cincinnati OH

210.720	\$57.25 each	2 @ \$51.50 each
----------------	---------------------	-------------------------



210.720



210.726

R&R Plasticast™ Investment

Plasticast was developed, and is ideally suited for, the investing and burnout of commonly used plastic or wax/plastic pattern materials. The high expansion of these pattern materials requires an equally high expanding, extra high strength investment. Plasticast provides a smoother, cleaner casting surface not obtainable with standard brands of investment. Plasticast is designed for easy removal in water, and provides a superior casting surface with standard injection waxes. 50 lb. box.

210.726	\$82.95
----------------	----------------



220.598

Castaldo® Mold Lock Formers

Stamped brass pieces are used in place of cutting registration locks in rubber molds. Essential when making molds using the powder separation technique. Excellent for silicone rubber and good for Gold Label®, White Label® and No Shrink Pink® as well. A typical mold requires 4-8 locks. Approximately 155 pieces.

220.598 **\$20.50**



210.790

221.625* -
221.630*

7-in-1 Mold Frame Set

Economical, efficient and effective. Save the cost of purchasing seven different frames with this three piece set, and you have the finest mold frames available in seven sizes up to 1 7/8" thick. This truly efficient system comes with all hardware and can adjust itself to these sizes: 1/2" 5/8" 3/4" 2 1/8" 1 1/4" 1 3/8" 1 7/8".

210.790 **\$45.25**

Mold Frames for See-Through Compound

Mold frame sets consist of U-shaped frame, two pieces of sheet glass and two clamps.

No.	Thickness	Width	Height	Price
221.625*	5/8"	2"	3"	\$30.50
221.626*	3/4"	2"	3"	\$31.85
221.627*	1"	2"	3"	\$38.15
221.628*	1 1/4"	2"	3"	\$39.20
221.629*	1 1/2"	2"	3 1/2"	\$42.00
221.630*	2"	2"	3 1/2"	\$47.25



221.580

Sprue Former

Attaches to model in mold frame to form opening in the mold through which the wax is injected. Assures a proper fit on the nozzle of the wax injector.

221.580 **\$2.25**



390.257

390.256

390.258

390.259

Mold Knives

Surgically sharp stainless blades fit into comfortable plastic handle or stainless handle. India.

390.256 Stainless Steel Handle only **\$5.50**
390.257 Plastic Handle only **\$6.25**

Blades:

390.258 #11 Straight **\$3.95/10** **\$26.25/100**
390.259 #12 Curved **\$3.95/10** **\$26.25/100**



221.0505* -
221.0507*

221.877

Adjustable Ingot Molds

The capacity indicated in the table below is the maximum. Each mold can be made smaller by adjusting the sides in a horizontal direction. The C-clamp releases the plates.

No.	Height mm	Length mm	Depth mm	Capacity		Price
				dwt	g	
221.0505*	70	45	4.5	150	233	\$43.95
221.854*	100	45	4.5	200	310	\$51.40
221.0507*	135	70	5.5	500	775	\$58.05

Reversible Ingot Mold

Gives you two ingot molds in one. Make wire sizes 3, 4, 5, and 6 mm in diameter with 130 dwt. capacity flat plates. C-clamp releases the plates.

221.877 **\$52.50**

Castaldo® Jewelry Molding Rubber

Consistent quality, flexibility and total control. Castaldo® pure natural gum rubbers come in two grades; soft and pliable White Label®, the industry standard, and Gold Label®, even softer and more pliable for difficult or delicate wax patterns.

Castaldo® Mold Rubber in Strips

Strips measure 2 7/8" x 18" x 1/8".

220.583	5 lbs. White Label®	\$54.95
220.584	5 lbs. Gold Label®	\$57.25
220.594	5 lbs. No Shrink Pink®	\$73.75
220.58301	1 lb. White Label®	\$11.50
220.58401	1 lb. Gold Label®	\$13.25



220.583 - 220.58401

Mold Rubber in Pre-Cut Sizes

Just open the box and these handy pre-cut sizes are ready to use. Pieces measure 1 7/8" x 2 7/8" x 1/8" and will fit most commonly available mold making frames. 5 lbs.

220.585	White Label®	\$57.25
220.586	Gold Label®	\$59.50
220.587	No Shrink Pink®	\$66.25

220.585 - 220.587



Castaldo® LiquaCast™ Molding Rubber

Stronger, tougher and longer lasting than any other, and less expensive to similar products on the market. Its low viscosity makes it easier to mix, easier to vacuum-debubble and easier to pour. Unlike molds made from other liquid rubber compounds, molds made of LiquaCast can be written on with ordinary pens and markers for easy identification. Two-part One lb. Kit

220.510	\$37.25
----------------	----------------

Cannot be shipped by air.



220.510

Castaldo® Mold Cream™

An easy way to eliminate or reduce mold cutting. No need for surgical knives or messy powder. Creamy lotion is spread on the mold with a fingertip or tool before vulcanizing. After vulcanization the mold opens automatically. Safe, non-toxic and non-hazardous. Use with natural and silicone rubber compounds. 1 oz

220.644	\$10.50
----------------	----------------

Castaldo® Mold Release Spray

Save time, eliminate broken patterns and improve the model with this easy to use product. Safe for all rubber molds. Before injecting wax, spray a small amount on the mold. Material is non-explosive and non-flammable, with no CFC's or VOC's. 6 oz.

220.640	\$16.50
----------------	----------------

Cannot be shipped by air.



220.640

Castaldo Plasto-O-Wax Blue Jewelry Injection Wax

Wax flakes offer the advantages of plastic with the ease and use of wax. Combines the excellent flow and fill characteristics of wax and the stability of plastic. Using wax tools and files is easy and unlike plastic-only pattern materials, it can easily be steam de-waxed. Plasto-O-Wax releases easily from any type of mold to produce patterns with smooth glossy surfaces, crisp detail and minimal shrinkage. Injects at 155-160°F. Extremely flexible with extraordinary memory. Patterns won't break and they have long storage life.

210.461	\$6.50/lb
----------------	------------------



220.644

210.461

FERRIS™ FILE-A-WAX Carving Waxes

Used for making models to be reproduced by the lost wax casting process. They can be sawed, filed or carved. Will stand rough handling and will not soften in your hands. Available in three degrees of hardness and in a variety of shapes.



File-A-Wax Bars

Pk. of 3 - 1/6 lb. Bars
3 3/4" x 1 1/8" Square

Individual 1/2 lb. Bars
3 1/2" Sq. x 1 3/8" Thick

Color	No.	Price	No.	Price
Blue	211.300*	\$16.75	211.305	\$10.50
Green	211.301*	\$17.60	211.306*	\$10.50
Purple	211.302*	\$17.60	211.307*	\$10.50

File-A-Wax Bar Assortment

Introductory kit contains three bars, one of each hardness. Bars are (3 1/2" x 1 1/2" x 1 1/4") and weigh approximately 1/6 lb. each.

211.290 **\$13.45**



File-A-Wax Slabs

Assortments of five square slabs measuring 3 5/8" in thicknesses: 7/8", 1 1/16", 3/8" and two slabs 3/16".

No.	Color	Price
210.380	Blue	\$19.75
210.381	Green	\$20.95
210.382*	Purple	\$20.95

File-A-Wax Slices

Assortments 3 5/8" x 1 1/2" in varying thicknesses. 1/2 lb. assortment thickness from 3/32" to 1/4"; 1 pound from 3/16" to 1".

Color	1/2 lb. Box	Price	Color	1 lb. Box	Price
Blue	211.384	\$17.90	Blue	211.388*	\$22.00
Green	211.385	\$17.90	Green	211.389	\$22.00
Purple	211.386	\$17.90	Purple	211.390	\$20.95

Color	Characteristics	Approx. Melting Point
Green	Cannot be flexed	240°F
Purple	Some flexibility	240°F
Blue	Will bend 90° on 1/8" thickness	240°F



File-A-Wax Ring Tubes

Easy-to-cut ring tubes for designing your own rings. Many rings can be made from each 6" long tube. All holes are 5/8" diameter.

Shape	Style. #	Measurements	Green	Purple	Blue
A	T-875	7/8" OD	210.362	210.358*	210.360
A	T-1062	1 1/16" OD	210.363	210.359*	210.361
B	E-1062	1 1/16" OD	210.366	210.364	210.365
C	T-100	1 1/8" H x 1 5/8" W	210.372	210.374	210.370
C	T-150	1" H x 1" W	210.371	210.392	210.391
C	T-200	1 5/16" H x 1 3/16" W	210.369	210.367*	210.368
C	T-250	1 1/8" H x 1 1/8" W	210.373	210.394	210.393
D	B-875	7/8" OD	210.377	210.379	210.375
D	B-1062	1 1/16" OD	210.378	210.399	210.376*

Above Ring Tube Numbers **\$10.75 each**



Ferris® Wolf Wax™ Ring Tubes

This designer wax was formulated to resemble gold and silver, and it's easy to read (medium tone to show highlights and colors that emphasize the beauty of gemstones). Slightly flexible with medium hardness, these gold & silver-toned waxes can be carved or machined into the finest details, fully polished and will withstand considerable handling. Burns-out cleanly from molds. Melting temperature 240°F.

211.0410	Solid Round	Gold	1 1/16 x 6"	\$11.95
211.0411	Solid Round	Silver	1 1/16 x 6"	\$11.95
211.0414	Round w/Center Hole	Gold	1 1/16 x 6"	\$12.60
211.0415	Round w/Center Hole	Silver	1 1/16 x 6"	\$11.95
211.0412*	Flat-Sided Off-Center Hole	Gold	1 x 1 1/8 x 6"	\$11.95
211.0413	Flat-Sided Off-Center Hole	Silver	1 x 1 1/8 x 6"	\$11.95

Ferris® Wolf Build-Up/Repair Wax™

This durable repair wax makes it easy to blend built-up and repaired sections. To insure thorough bond, melt model where repair wax is to be added. 1 7/16" Sq x 3 5/8".

211.0400	Gold	\$11.50
211.0401	Silver	\$12.10



Modeling Waxes

A selection of waxes used for making models to be reproduced by the lost wax casting process. The waxes can be manipulated easily and worked with a heated spatula. Different types can be joined together to build a model. Measurements are by B & S gauge.

VIGOR® Injection Waxes

For all-purpose applications. Highly fluid when melted, for easy injection and release even with the most intricate molds. Consistently reproduce your molds with perfect results. Melts at 150° F.

Aqua Hi-Production - For medium to large parts. Lowest shrinking of all waxes. 1 lb. slab

211.453F **\$9.90**

Aqua Super-Ject - All purpose, very tough. 1 lb. flakes.

211.454 **\$14.95**

50 lbs. Minimum Order

VIGOR® Utility Wax

Soft, easily shaped red wax adheres to practically any surface. Used for building in and filling in marred surfaces. Often used to fill sprue bases. Sticks size 5" x 3/16" or sheets 3" x 6" x 1/8".

211.517 Box of Sticks **\$20.50**

211.518 Box of Sheets **\$19.50**

VIGOR® Sheet Wax

In varying thickness, either firm or soft. Designs can be traced directly on sheet and cut with scissors or carving tool. 4" Squares

Firm (Green)	Soft (Pink)	Gauge	Price
211.470	211.471	Asst.	\$20.30
211.480*	211.489*	16	\$20.80
211.481*	211.491*	18	\$20.80
211.482*	211.493*	20	\$20.80
211.483*	211.495*	22	\$20.80
211.484*	211.497*	24	\$20.80

3" x 6" Sheets. Last 2 digits indicate gauge.

Firm (Green)	Soft (Pink)	Price
211.0615/16	211.0617/16*	\$33.55
211.0615/18	211.0617/18*	\$33.55
211.0615/20*	211.0617/20*	\$33.55
211.0615/22*	211.0617/22*	\$33.55
211.0615/24*	211.0617/24*	\$33.55
211.0615/26*	211.0617/26*	\$33.55

VIGOR® Cool Setting Wax

Very pliable when heated and shapes easily. Unusually tough and will stand bending without cracking. When cool, it will hold its shape and is easily carved. Sheets measure 6" x 3" x 1/20".

211.450* **\$15.95**

VIGOR® Inlay Wax

For building up wax patterns. Can be carved without chipping or flaking and softened over a flame, in hot water or with a heated tool. Two grades of hardness, in boxes of 18 sticks 4" x 1/4".

211.458* Hard **\$17.85**

211.459 Regular **\$17.85**

VIGOR® Sprue Wax

Ample flexibility and sufficient rigidity make this wax particularly suited for making sprues. Melts at lower temperatures, permitting pattern waxes to be more easily eliminated during burn-out. 6" sticks.

211.510 Gauge 8 **\$15.95**

211.511 Gauge 10 **\$16.80**





PRO-CRAFT® Sand Casting Set

For casting simple metal articles such as jewelry and small sculpture in sand. Preparation of the sand mold is simple and quick and the original pattern or article can be used over and over. The set contains all necessary items (except a melting torch); parting powder, 5 lb. can of sand, crucible, crucible tongs, borax, asbestos-free pad, casting flask (horizontal or vertical fill) measuring 4¾"H x 3"W x 2"D and manganese bronze casting metal. Shipping weight 10 lbs.

221.949*	\$119.75
221.952* Replacement Casting Flask	\$49.95
221.957 Sand only	\$24.45

Sticky Wax in Sticks

Used like an adhesive to weld waxes together. Box contains 12 sticks, 3½" in length.

211.515	\$11.60
----------------	----------------



211.515

VIGOR® Wax Wire Assortment

Pliable blue wax wires can be twisted or bent to desired patterns. The assortment contains gauges 6, 8, 12 and 14 half-round; gauges 10, 14 and 18 round; and gauge 6 half-pear shapes. 4" long.

211.530	\$25.50
----------------	----------------

VIGOR® Round Wax Wire

Pliable, round, blue wax wire. Assortment of gauges 6, 8, 10, 12, 14, 16, 18 and 20.

211.532	\$24.70
----------------	----------------

Measuring Cylinders

Plastic Cylinders for measuring the correct amount of water to mix with investment and determining the amount of metal to be cast by the displacement method.

No.	Capacity	Price
211.740	250 ml	\$22.50
211.74010	1000 ml	\$16.50
211.74011*	3000 ml	\$24.80



211.530
211.532



211.740



211.74010



221.645



211.05600

Porosity Killer

Hammer metal (gold, silver, platinum, etc) into minor porosity holes in castings, eliminating the need for extra filing and filling of holes with solder. Works at high speed in flex-shaft machine. 3/32" shank.

211.05600	\$16.75
------------------	----------------

PRO-CRAFT® Mold Parting Powder

Provides clean mold separation. 1lb. can.

221.645	\$9.45
----------------	---------------

Wax Wire Comparison

Gauge	Inches	Gauge	Inches	Gauge	Inches
6	.162	16	.051	26	.016
8	.129	18	.040	28	.013
10	.102	20	.032	30	.010
12	.081	22	.025		
14	.064	24	.020		

Casting Flasks and Sprue Bases

Handy chart below makes it easy to match the sprue base type you desire with the proper casting flask. All flasks are durable stainless steel. Matching sprue bases assure a leak-proof seal. Button Sprue Base-Fill cup in the center with wax or clay to form the base for sprue. Tree Sprue Base - Perfect for high production operations.

Casting Flasks				Recommended Sprue Bases			
Flask	Price	Diameter	Height	Button	Price	Tree	Price
—	—	—	—	211.776*	\$4.25	—	—
—	—	—	—	211.777*	\$4.55	—	—
211.687	\$7.20	1¾"	1¾"	211.778*	\$4.80	211.825	\$5.80
211.68701	\$11.60	2"	2½"	211.779	\$5.30	211.824	\$3.80
—	—	—	—	211.781	\$4.80	211.826	\$4.20
211.689	\$12.60	2½"	2½"	"	"	"	"
211.690	\$13.25	2½"	3"	"	"	"	"
211.691	\$15.00	2½"	4"	"	"	"	"
211.692*	\$6.25	3"	2¼"	211.782	\$5.25	211.827*	\$5.00
211.693	\$15.55	3"	2½"	"	"	"	"
211.694	\$15.80	3"	3"	"	"	"	"
211.695*	\$19.45	3"	4"	"	"	"	"
211.696*	\$15.80	3½"	2½"	211.783	\$5.65	211.828	\$5.10
211.697*	\$10.50	3½"	2¾"	"	"	"	"
211.69701*	\$10.75	3½"	3"	"	"	"	"
211.698	\$19.95	3½"	4"	"	"	"	"
211.699*	\$25.20	3½"	5"	"	"	"	"
211.69901	\$24.50	4"	4"	211.784	\$8.25	211.829	\$4.95
211.701*	\$28.95	4"	5"	"	"	"	"
211.70201*	\$42.50	5"	7"	"	"	"	"



211.685 -
211.70201*



211.824 -
211.829

211.776 -
211.784*

Stainless Steel Perforated Flasks for Vacuum Casting

Heavy-duty, with machined perforations, help assure a perfect cast since metal is being forced into cavities from all directions.

Flask	Price	Diameter	Height	Sprue Base	Price
211.705*	\$79.95	3¾"	4"	211.882	\$5.10
211.703*	\$55.75	4"	4"	211.829	\$4.95
211.706	\$78.95	4"	5¾"	211.829	\$4.95
211.70401*	\$65.75	4"	8½"	211.829	\$4.95



211.882
211.829



211.708 -
211.711



211.703 -
211.70401

Latex Rubber Sleeves for Perforated Flasks

No more messy masking tape. Place over flask to contain the investment while pouring and also form a collar so that no spilling occurs. Dimensions listed are for the flask that each sleeve will fit. Sleeve should be removed prior to burnout.

No.	Diameter	Height	Price
211.708	3¾"	4"	\$13.00
211.709	4"	5¾"	\$17.70
211.711	4"	7"	\$21.65



211.890

Sprue Base Holder

Holds sprue bases from 3" to 5". Heavy base for stability and adjustable top for varied working angles.

211.890 \$32.25

Universal Sprue Bases

One size fits all flasks except the smallest and largest diameters. Center is type used for tree sprueing. Fits 2½", 3" and 3½" flasks.

211.780 \$4.50



211.780



Rubber Flask Extenders

Slip over the flask to fill casting flasks to the top with investment. Prevents spilling of investment.

No.	For Flask Diam.	Price
211.797*	2½"	\$12.95
211.798*	3"	\$14.50
211.662*	3¾"	\$7.50
211.799*	3½"	\$15.25
211.664*	4"	\$7.50
211.665*	5"	\$8.95



221.791



221.890



571.080



571.060*



571.068



570.052



221.901

221.902

211.905



220.753

PRO-CRAFT® Melting Dish with Wooden Handle

Removable handle makes it easy to melt and pour metals. Wood resists heat. Fused silica dish with clay bond is suitable for melting metals with high melting points, including platinum. Overall 14".

221.791	Dish with handle	\$27.30
221.793	Dish only	\$17.90
221.798	Handle only	\$9.45

Melting Ladle

Made of steel and designed for left or right pouring. Bowl diameter is 3" and handle length is 11 1/2".

221.890		\$28.50
---------	--	---------

Crucible and Flask Tongs

For picking up crucibles and 1 1/2" diameter flasks. 19" length.

571.080		\$19.50
---------	--	---------

Burno Crucible Tongs

10 1/2" length.

571.060*		\$4.50
----------	--	--------

Flask Tongs

For lifting small and large flasks to and from oven. 15" length.

571.068		\$7.95
---------	--	--------

Copper Tongs

Will not contaminate pickling and acid solutions which can cause discoloration.

570.052		\$5.75
---------	--	--------

Carbon Stirring Rods

For stirring gold in crucible while melting.

221.901	9" length with 1/4" diam.	\$7.35
221.902	12" length with 1/2" diam.	\$10.30

Stress-Relieved Quartz Stirring Rod

Superior quality clear quartz rods are annealed and fire polished to eliminate flaking. Ideal for stirring molten metal. Overall length 12" x 3/8" diameter. Melting point 3183°F.

211.905		\$27.85
---------	--	---------

Asbestos-Free Gloves

A must for doing work around burnout ovens, vulcanizers, and when melting gold. Do not attempt to use tongs to lift flasks and crucibles into or out of the furnace without protecting your hands. Durable, yet comfortable, these full length gloves cover your wrists. One size fits all. Always use on both hands.

220.753		\$95.40 pr
---------	--	------------

Melting Crucibles

Made of fused silica with clay bond, for melting temperatures up to 2500°F. Best choice for gold, silver, bronze, etc.

No.	Diameter	Height	Price
221.760	2 ³ / ₈ "	2 ⁷ / ₈ "	\$15.95
221.761*	3 ¹ / ₂ "	3 ¹ / ₂ "	\$21.00
221.762*	4"	4 ¹ / ₂ "	\$24.95



221.760 -
221.762



221.766 -
221.773

Graphite Crucibles

Resistant crucibles, often called black lead, withstand heat up to 3000°F and will tolerate thermal shock.

No.	Size	Height	Top O.D.	Bottom O.D.	Price
221.766*	4/0	3 ¹ / ₈ "	2 ³ / ₈ "	1 ³ / ₄ "	\$33.60
221.767*	1	3 ⁵ / ₈ "	3 ¹ / ₂ "	2 ¹ / ₄ "	\$37.75
221.768*	2	4 ⁹ / ₁₆ "	3 ⁷ / ₈ "	2 ³ / ₄ "	\$43.75
221.769*	3	5 ¹ / ₄ "	4 ¹ / ₄ "	3"	\$52.95
221.770*	4	5 ¹ / ₂ "	4 ³ / ₄ "	3 ¹ / ₈ "	\$55.75
221.771*	6	6 ⁵ / ₈ "	5 ³ / ₈ "	4"	\$69.95
221.772*	8	7"	5 ⁷ / ₈ "	4 ³ / ₈ "	\$79.95
221.773*	10	8 ¹ / ₁₆ "	6 ¹ / ₁₆ "	4 ¹⁵ / ₁₆ "	\$103.95

Shipping Weight 221.772 - 6 lbs., No.221.773 - 9 lbs.



211.760* - 211.764*

Rubber Mixing Bowls

No.	Diameter x Height	Capacity	Price
211.760*	3" x 3"	1/4 pt	\$4.20
211.761*	4 ¹ / ₄ " x 4 ¹ / ₄ "	3/4 pt	\$6.35
211.762*	5" x 5"	1 pt	\$6.85
211.763	6" x 6"	1 ¹ / ₂ qt	\$11.85
211.764*	9" x 9"	1 gal	\$24.45

Ingot Molds for Wire

Each mold contains three sizes. Regular sizes: 19 x 8 x 170 mm, 9 x 9 x 170 mm and 7 x 8 x 170 mm.

221.0510 **\$13.25**

Extra long sizes: 8 x 6 x 245 mm, 6 x 6 x 245 mm, 5 x 6 x 245 mm.

221.0501* **\$30.80**



221.0510

Open Ingot Molds

Forms ingots or bullion of various sizes as shown below.

Shipping weight of No.221.872 is 6 lbs.

No.	Depth mm	Length mm	Width mm	Capacity		Price
				dwt	g	
221.870*	35	90	35	50	78	\$27.50
221.871*	30	120	45	80	124	\$29.80
221.872*	40	155	65	200	310	\$31.90



221.870*
221.871*
221.872*

Cuttlefish Bone

For casting small objects. Press model directly between two pieces of cuttlefish. The soft shell makes a smooth walled mold. Sprues, gates and vents are cut into the wall with a sharp knife. The two halves are held together with binding wire and the molten metal is poured into the cavity. Package contains six pieces.

221.930 **\$25.95**



221.930



221.450

221.452

221.453

221.454



221.470*

221.471



221.783*

221.782

221.781

221.780

221.755 -
221.757

221.793



221.795

220.000



221.815

221.816

PRO-CRAFT® Centrifugal Casting Machine Crucibles

Replacement crucibles for the centrifugal casting machines. Made of fused silica with a clay bond which will last through many meltings. Best choice for metal melting up to 2500°F.

No.	Capacity (oz)	(g)	(dwt)	Price
221.450	2½	77	50	\$14.25
221.452	12	340	250	\$31.35
221.453*	17	482	350	\$35.20
221.454***	12	340	240	\$29.45

**221.454 with slot to fit Vigor and Pro-craft casting machines.

WESGO Brand Crucibles

Suitable for high temperature melting of platinum, chromium, gold alloys, etc.

No.	Type	Capacity in Platinum (oz)	(g)	Price
221.470*	Small A		1 28	\$36.50
221.471	Large A		3 85	\$42.80

Fused Silica Crucibles

Made of clay bonded fused silica for melting temperatures up to 2800°F. Excellent for melting gold and silver. Available in a variety of sizes or as a set of four.

No.	Diameter	Depth	(dwt)	(g)	Price
221.780	1¾"	5/8"	20	48	\$6.75
221.781	2¼"	3/4"	40	96	\$7.95
221.782	3"	1"	100	155	\$8.70
221.783*	4"	1¾"	175	420	\$9.80
221.784*	Set of All 4 Fused Silica Crucibles				\$32.05

Burno Style Crucibles

Protective heat-holding covers make these efficient for melting with a torch. Handy pouring openings. Fused silica with clay bond, for melting up to 2500°F. Best choice for gold, silver, bronze, etc. Use with Tong No.571.060.

No.	Capacity	Price
221.755*	25 dwt.	\$17.95
221.756	50 dwt.	\$19.80
221.757*	100 dwt.	\$23.45

PRO-CRAFT® Melting Dish

Particular style makes it easier to melt with a torch. Made of fused silica with clay bond and suited to high melting temperatures. Handle No.221.798 can be added to make pouring easier.

No.	Type	Capacity oz.	grams	Price
221.793	Straight side	7½	213	\$17.90
221.795	High back	20	567	\$19.30

Crucible Neycraft Centrifugal

Fused silica ceramic crucible designed to fit the Neycraft centrifugal casting machine. Suitable for melting temperatures up to 2500F. 9 oz gold capacity, 6.5 oz 14K gold, 5 oz sterling.

220.000	\$35.25
----------------	----------------

WESGO Melting Dish

For high temperature melting, including metals such as platinum.

No.	Type	Capacity oz.	grams	Price
221.815*	Straight side	8	227	\$36.55
221.816*	High back	10	283	\$40.45

Wax Carving Tools

Wax Detailer Set

A phenomenal tool for filing and shaping wax. Our detailers are so small that they can go where no other tool can go. The points have file-like edges to cut smoothly and quickly. Detail filigree with ease. Clean small, tight corners in wax patterns and enlarge small holes. Stainless steel tips will not rust. Set of fine and extra fine with a comfortable wood handle. 5" long. American made.

210.102 **\$9.95**

Supreme Wax Tools let you carve, not scrape

Revolutionary wax carvers allow the user to actually carve the wax rather than scrape it away. Loops are sharp on one edge. Set includes four shapes, two sizes each. Great for making designs, for smoothing, or to use with wax lathes for making rings. Made of surgical-grade stainless steel with a sure-grip handles.

210.101 **\$24.25**

Wax Carving Set

Sharp Edges. Set of 6.

210.402 * **\$20.95**

Set of Six popular Carvers, Spatula, and Probes

Consists of one each of items 211.114, 211.115, 211.116, 211.141, 211.251 and 211.252.

211.100 **\$13.95**

Six Wax Files

Set of six. Excellent for shaping wax, wood or plastic. Overall length 6". Wide tooth style does not clog as easily as regular style files. India.

330.923 **\$5.25**

Wax File Set

Set of 3 EuroPoint files with non-roll handles.

330.924 **\$13.25**

Wax Tools or Probes with Stainless Steel Needles

Hard chrome plated handles with stainless steel needles.

211.250 Curved 6 1/4" **\$4.25**

211.251* Angled 5 1/2" **\$4.75**

211.252 Straight 5 5/8" **\$4.50**

211.254* Set of all 3 of above **\$11.55**



210.102



210.101



210.402

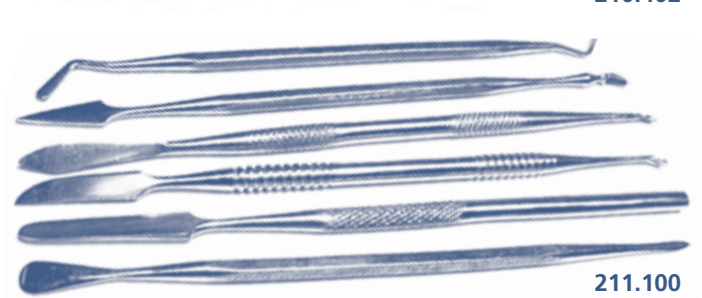

211.100



330.923

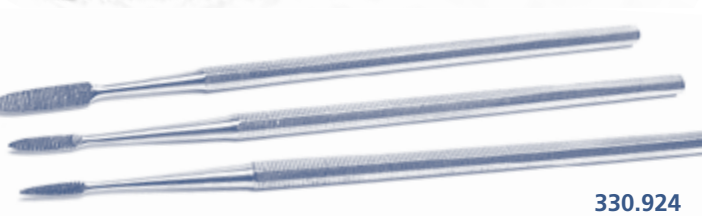

330.924

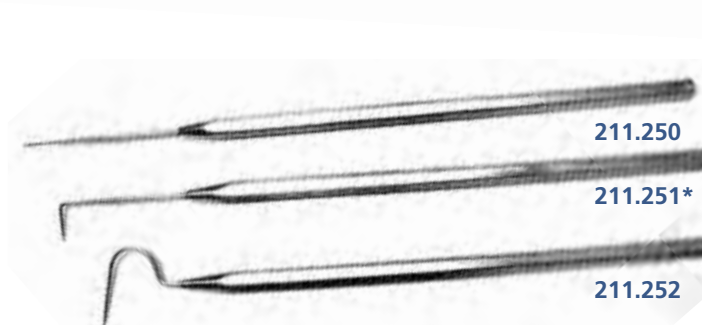

211.250

211.251*

211.252

Stainless Carvers

Overall length approximately 6 1/2".

211.110	Ward #1	\$7.75
211.111*	Ward #2	\$8.15
211.113*	Hollenback #1/2	\$8.15
211.114*	Hollenback #3	\$8.15
211.115*	LeCron #5	\$8.15
211.116*	Roach #6	\$8.15
211.0825/16	Spatula	\$8.80
211.0825/18*	Spatula Vehe #50	\$8.80
211.117*	Norustand Cement	\$8.15
211.150	Norustand Cement #1	\$7.75
211.151*	Norustand Cement #2	\$8.15
211.152*	Norustand Cement #3	\$8.15



540.131



211.02890*

Ceramic Ring Stand

6" ceramic rod on swivel base holds rings, leaving both hands free.

540.131 **\$34.50**

540.132 Replacement Ceramic Rod **\$8.50**

MATT Wax Ring Tube Sizer

Hardwood mandrel is specially machined to incorporate a cutting steel blade to scrape the inner wall of a wax ring, enlarging the ring to the size marked on the mandrel, leaving a smooth and even finish on ring.

211.02890* **\$40.50**

Find more ring mandrels and sizers on pages 203 - 207.

Swiss Made Wax Bur Set

Each bur features coarse, no-clog flutes and is made of tungsten vanadium for years of service. Shanks are 3/32" for quick change handpieces. Excellent for wood and plastic carving as well. Swiss.

190.889 **\$13.25**

Wax Kleen™

Removes scratches, smooths and cleans wax patterns prior to casting. Produces cleaner castings requiring less finishing. Acid-free, water-soluble and 100% organic. Fast - rub on with cloth and let air dry. Ideal for cleaning wax injectors.

211.0806 4 oz. **\$11.10**

211.0807* 8 oz. **\$21.30**

Skip-A-Tooth Saw Blades

Designed for wax cutting. Every other tooth is eliminated to provide smooth cutting. Non-loading. 1 dozen size #1 blades.

491.320 **\$3.75 dz**



190.889



211.0806
211.0807



491.320

Vigor Casting Metals - Inexpensive casting metals that give the appearance of gold and silver. Tarnish resistant and will not discolor when heated. Comes out of investment bright and shiny, reducing the need for stripping or pickling. Can be electroplated and soldered with gold or silver solder.

Columbian Gold - Yellow bronze metal is a bit softer in color than rich gold. Melts and flows just like real gold at about 1800°F. Comes in 1 lb. package.

431.01303/1* **\$43.35**

Silver Mine - White copper-based alloy is very close to the color of sterling, but has the advantage of being considerably harder. Retains a high polish and melts at about 1550°F.

431.01307 2 oz. **\$10.55**

431.01307/1* 1 lb. **\$53.85**

Pewter - Lead-free and melts at about 450°F. An excellent metal for small sculptures. Comes in 1 lb. package.

431.01317* **\$59.95**



Soft Metal in Squares

All are 12" x 12" except nickel silver, which is 6" x 12". Dixgold is popular because it resembles gold in color and copper in workability.

B&S Gauge	16	18	20	22	24	26
Brass	431.400*	431.401*	431.402*	431.403*	----	----
	\$55.95	\$46.75	\$37.10	\$29.95	----	----
Copper	431.420*	431.421*	431.422*	431.423*	431.424*	431.425*
	\$49.95	\$44.45	\$36.30	\$28.15	\$25.75	\$25.75
Dixgold	----	431.441	431.442*	----	----	----
	----	\$51.45	\$40.50	----	----	----
Nickel Silver	431.460*	431.461*	431.462*	----	----	----
	\$49.95	\$40.50	\$34.95	----	----	----

Rolls of metal are available by special order.



Iron Binding Wire - Comes in 8 oz. spools.

No.	Diam.	B&S Gauge	Price	No.	Diam.	B&S Gauge	Price
431.638*	.020"	12	\$10.50	431.644*	.010"	24	\$17.40
431.639*	.018"	14	\$10.50	431.645*	.009"	26	\$19.25
431.640*	.016"	16	\$9.75	431.646*	.008"	28	\$25.00
431.641	.014"	18	\$11.90	431.647*	.007"	30	\$28.95
431.642*	.0125"	20	\$12.40	431.648*	.0065"	32	\$18.95
431.643*	.011"	22	\$17.40				



**431.638 -
431.648**

Casting Alloy

Mixes with bullion to make 10K, 14K or 18K gold. Can be rolled, stamped or cast. Casting temperature 1950°F.

Flash temperature 1200°F.

16-121-1 Yellow **\$11.75 per oz**

16-121-2 White **\$10.95 per oz**



16-121

Steel, Brass and Nickel Silver Wire

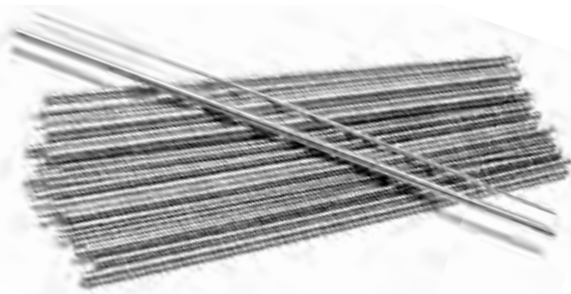

Assorted Brass Wire

6" long in assorted gauges. 23 pieces.

430.500 **\$13.75**

Brass Rivet Wire

6" lengths in assorted sizes from 14 to 21 by B&S gauge. Used to make pins, rivets, hinges, etc. Comes in 1 oz. package.

431.501 **\$4.50**

All Purpose Wire

Nickel Silver wire, 6" long in assorted sizes from 20 to 70 by drill gauge.

431.0609 **\$10.45**

Assorted Steel Wires

6" lengths in assorted sizes from 20 to 70 by drill gauge. Packed in plastic tubes.

431.700 **\$16.50**



Stainless Wire for pins and rivets

Soft tempered stainless steel rivet wire is ideal for making bracelet pins. Assortment has 4 each of 7 sizes .60 thru 1.20mm. 6" long.

430.699 **\$18.25**

6" Stainless Wire individual diameters

430.696 0.83mm **\$8.25 dz**

430.697 0.99mm **\$8.25 dz**

430.698 1.20mm **\$8.25 dz**

Soldering Metals...
see pages 278, 281.

Pliers & Cutters...
see pages 155 - 171.

Wire Cutting Tweezers...
see page 186.



Peerless Round Spring Steel Wire

For making watch parts, loupe springs and many other items requiring spring steel. Tempered and ready for use. Comes in 36" coils, in B&S gauge sizes as noted.

No.	B&S	Price	No.	B&S	Price
430.715	15	\$5.75	430.723	23	\$5.75
430.716	16	\$5.75	430.724	24	\$5.75
431.717	17	\$5.75	430.725	25	\$5.75
430.718	18	\$5.75	430.726	26	\$5.75
430.719	19	\$5.75	430.727	27	\$5.75
430.720	20	\$5.75	430.728	28	\$5.75
430.721	21	\$5.75	430.729	29	\$8.25
430.722	22	\$5.75	430.730	30	\$8.25



Wire & Sheet Gauge

Pocket Wire Gauge measures wire and sheet sizes 34, 32, 30, 28, 26, 24, 22, 20, 18, 16, 14, 12, 10 and 8. Each size is also shown in fractions of millimeters and inches. This is the perfect gauge for bead makers, wire wrappers and jewelers to easily identify wire or sheet gauge. 3 5/16" x 1" with leather sheath.

350.105 **\$12.95**

Lubricant for Drawing

Apply a small amount of lubricant to the wire and the opening. The reduced friction makes drawing much easier and faster. 2 oz. Push-up Container.

191.928 **\$5.25**



Soft Copper Binding Wire

Comes in 4 oz. spools.

No.	B&S Gauge	Roll Length	Price
431.559	14	20.0 ft	\$9.50
431.560	16	32.5 ft	\$9.50
431.561	18	51.0 ft	\$10.50
431.562	20	80.0 ft	\$11.05



Swiss Made Draw Plate

Top quality drawplate with tungsten carbide inserts in a steel baseplate. 39 round holes, sizes 0.26 thru 2.80.

280.025 **\$113.95**



Draw Tongs

Forged steel pliers for pulling wire through drawplates. Jaws are serrated for strong grip on wire. Formed handle aids in pulling. 10" long, jaws 1 1/4" x 7/8".

570.058 **\$28.75**



280.195



PEPETools Rolling Mill

Full Combination Rolling Mill requires minimal effort from you. Plate steel (not cast metal) construction allows for better geometry, closer tolerances.

- Roller hardness 60-62 Rockwell. Carbon tool steel rollers are capable of producing metal foil as thin as .001".
- 4:1 gear ratio transfers force from the handle to the rolls with minimal effort from the operator.
- Roller diameter: 42.6mm, width: 90mm. Maximum opening: 0-4mm
- Flat area: 38mm. Square wire: 1.5, 2.0, 3.0, 4.0 and 5.0mm.
- Ring Shank (half round): 2.5x1, 3x1.25, 4x1.5mm.
- Dimensions: 10"L x 4¾"W x 10¼"H (not including handle).
- Shipping Weight: 34lbs., F.O.B. Cincinnati, Ohio

280.195

\$549.95

Cordless Electric Quick Coiler

Stop that laborious cranking and try the comfortable pistol grip Quick Coiler. Each mandrel has the universal hexagonal fitting for quick and easy changes. Set includes drill/screwdriver with plug-in charger, eight mandrels, screwdriver bits and a wooden storage box.

430.010

\$65.95



1.0, 2.0, 2.5, 3.0, 4.0, 5.0, 6.0 and 8.0mm

430.010

Make ear wires in seconds with the Easy Ear Wire™

Make your own ear wires as you need them, for less than half the usual cost. Easy to use, fully automatic and hand operated, the Easy Ear Wire™ maker creates ear wires from a straight piece of wire in seconds. Your customers will appreciate that even your ear wires are now hand made by you. Instructions included.

370.000

\$27.50



370.000

Bead Buddy 1-Step Earwire Maker

Create earwire with one squeeze of the handle. For 20, 22, and 24 gauge wire. Cut wire two inches length and straighten the wire. Open the handles fully and insert the wire, resting it against the snapper. Place your thumb on the 'teardrop' shape in the center and press down the handle slowly. Loosen your hand on the tool and reach in, lifting the wire from the tool.

360.212

\$19.95



360.212



370.870

Wire Bending Jig

Create round and square shapes in wire easily with this handy jig. Four removable pins may be arranged for bending unlimited shapes. Includes screws to mount to your bench. 4¾" x 1".

370.870

\$10.50



460.412

Coil Cutting Pliers

This unique tool holds wire coils so that they can be efficiently cut into jump rings. Made of stainless steel, the Coil Cutting Pliers feature a jaw which firmly but gently grasps coils ranging from 4.5 to 9.0mm (outside diameter). The jaws feature slits that allow the user, with a jeweler's saw and a 2/0 sawblade, to quickly cut multiple jump rings. 7" Pliers are box-jointed with comfort grips.

460.412

\$28.75

This valuable guide lets any collector make on-the-spot judgements about identification, age, quality and value.

620.030



Complete Price Guide to Watches

By Shugart, Engle, Gilbert. The most reliable and convenient guide available. This annual book is a miniature encyclopedia with over 1,224 pages, over 10,300 watches listed with current values, and more than 7,800 illustrations. The professional standard for watch collectors and dealers. Updated yearly.

620.030.37 **\$29.95**

An updated Price Guide is published each year. Ask about the most recent edition.

Dimensions of American Balance Staffs

Cas-Ker Exclusive! Julian Smith has compiled this list of Dimensions of American Balance Staffs. Covers Chelsea, Columbus, Elgin, Hamilton, Hampden, Howard, Ingersoll, Illinois, Mount Vernon, New England, New York Standard, Rockford, Seth Thomas, South Bend, and US Watch Co., and Waltham. 15 pages 8 1/2 x 11" soft cover.

620.507 **\$15.50**

Illustrated Manual of American Watch Movements

This manual was first published in 1952 by E. & J. Swigart Co. The soft cover book has over 200 pages (8 1/2 x 11") illustrated with Hamilton, Waltham, Illinois, Elgin, South Bend, and Bulova pocket and wrist watch movements and parts. One of the most useful books on American made pocket and wrist watches, it was written for watch-makers, but is also very useful for students and hobbyists. An essential book for anyone working on American movements as it lists the factory part numbers of each part so that you can know exactly what you are looking for.

620.020 **\$26.95**

Bergeon Essentials Mini Catalog

Handy condensed catalog from the famous Swiss tool manufacturer is packed with all their essential products. 6" x 8.5", 563 pages.

640.BERG **\$5.50**

Cas-Ker Case Parts Catalog

A Cas-Ker exclusive, with over 68,000 case number listings for Bulova, Citizen, and Hattori case numbers. The catalog lists case number with corresponding crystal, crown and stem in 295 pages. An invaluable tool for any watchmaker.

900.101 **\$15.70 Value**

Free with any order shipped UPS

Cas-Ker Watch Movement Catalog

80 pages feature over 500 different movement models and lists dimensions, dial feet position, hand size, and the correct stem and battery for each. Prices, illustrations and Interchangeability list are also included.

900.110 **Free on Request**



620.507



620.020



640.BERG



900.101



900.110

Do you have all our latest product catalogs?

WATCH MATERIAL ASSORTMENTS | WATCH CRYSTALS | GENERIC PARTS FOR RLX | WATCH MOVEMENTS | POCKET WATCH PARTS | WATCHBANDS & STRAPS | BULK WATCH PARTS | CLOCK MOVEMENTS | JEWELER'S FINDINGS | PACKAGING

Our mini-catalogs can be downloaded FREE from our website at casker.com, or call 1-800-487-0408 to request your copy with your next order.

Wristwatches - A Handbook and Price Guide

Revised 4th Edition by Gisbert L. Brunner & Christian Pfeiffer-Belli. This classic pocket guide is designed for the collector, with a historical survey, a description of how mechanical wristwatches work, and a glossary. Newly updated prices for various watches are included, along with a chapter on fakes, knock-offs, and hybrids. Preservation, care, and repair of the watch rounds out the volume, making it an excellent reference. 7" x 10" Soft Cover, 192 Pages, 480 Illustrations and photos .

620.476 **\$36.50**



620.476

Electrical Test Values for Quartz Watches

This book by Jordan P. Ficklin, CW21, is intended to be a practical reference book for those familiar with testing procedures for quartz watches. You will find all the useful electrical values for more than a thousand quartz calibers from most of the modern quartz manufacturers. These values can be used in determining movement condition and for troubleshooting problems in quartz movements. 56 pages, soft bound.

620.502 **\$31.50**

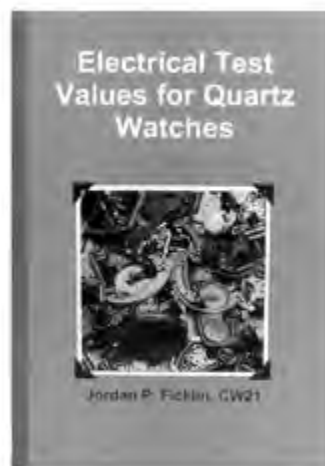

620.502

An invaluable reference for today's watchmaker

Rolex® Wristwatches - An Unauthorized History

Second edition by James M. Dowling & Jeffrey P. Hess. The watches produced by Rolex over the last 90 years are celebrated in this lavishly illustrated classic. The authors have captured the watches' beauty in color photography and present the most thorough and extensive history written of the company. Info for collectors and newly revised market values make this a truly useful volume. 9" x 12", Hard Cover, 392 photos, 320 Pages.

620.477 **\$129.95**

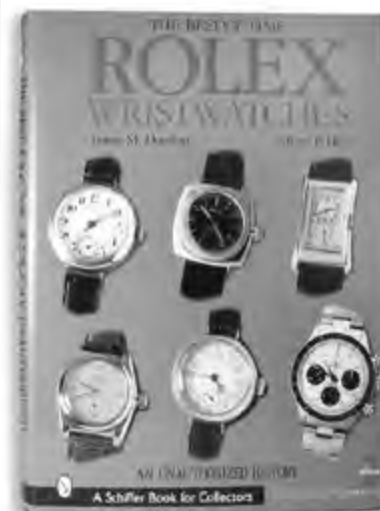

620.477

"Servicing the Modern Pocket Watch" DVD Video

A production from the American Watchmakers-Clockmakers Institute. The video features the complete assembly and disassembly of the UT6497 mechanical movement that is used in many pocket watches in production today. Approximately one hour.

630.011 **\$41.95**



630.011

Practical Watch Repairing

By Donald de Carle, FBHI. Contains 550 illustrations describing the theories and processes of repairing and adjusting the modern watch precisely and with meticulous detail. Hard cover, 299 pages.

621.224 **\$22.05**



621.224

Practical Clock Repairing

By Donald de Carle, FBHI. Deals with the usual faults likely to develop in each type of movement in general use, from grandfather to alarm clocks. All tools and equipment are described and illustrated, along with information on proper use. 400 illustrations. Hard cover, 240 pages.

621.225 **\$52.50**



621.225



620.170



620.171

Soldering Made Simple Book for the home market

Joe Silvera demonstrates with detailed photos and instructions how to make professional quality jewelry right at your kitchen table . . . all with a hand-held butane torch. Learn about the tools and materials you will need for a home setup as well as fundamental soldering techniques. Start the projects that Joe explains in step by step detail. A must have for anyone learning to solder. 111 pages, soft cover.

620.171 \$22.95

Soldering Made Simple DVD Video Workshop

Learn to solder using master craftsman Joe Silvera's professional techniques, an easy-to-use butane torch and a simple home setup. Learn about tools, flux and other materials as well as safety, fueling and lighting your torch. Soldering jump rings, melting sterling silver into a ball, sweat-soldering, forging wire, soldering near beads and using a third hand are demonstrated in this 92 minute video. NTSC DVD for Mac, PC and DVD players.

620.170 \$20.95



621.451*

621.452



Jewelry Making

By Murray Bovin. Revised and enlarged edition. Clear text, with useful photographs and diagrams of fundamental processes and techniques such as enameling, plating and etching. Includes sections on the three types of casting, stones used for jewelry and methods of setting stones. 288 pages.

621.451* Soft Cover \$37.05
621.452 Hard Cover \$36.50

The Jeweler's Bench Reference

By Harold O'Connor. A wealth of information on findings, processes, techniques and materials for the novice or intermediate craftsman. Expert information on jewelry making techniques. Soft cover, 68 pages.

621.460 \$17.50

Jeweler's Resource By Bruce Knuth

A Reference of Gems, Metals, Formulas, and Terminology for Jewelers. A unique and practical tool for the bench jeweler and student, as well as the retail jeweler. Easy to follow text and illustrations including: a listing of gems and gem properties, a list of birthstones, diagrams of more than 40 gem cutting styles, legal standards of jewelry marketing, ring size gauges and sizes, measurement conversion tables and more. Soft cover, 112 pages.

621.443A \$28.35

GROBET USA® Plating Guide

Complete booklet on plating precious metals. Soft cover, 21 pages. This manual provides a description of some of the more common plating processes and explains how these processes can be carried out using comparatively simple equipment. No knowledge of chemistry will be required. It is assumed that prepared electroplating salts or solutions will be used.

621.01215 \$6.65



621.01215

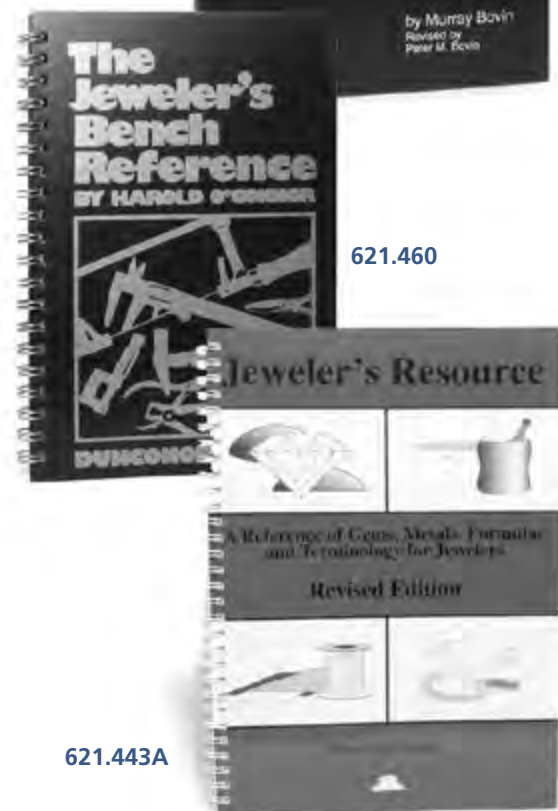

621.460

621.443A

Find great **FREE** resources at casker.com!
 Download Cas-Ker's product catalogs, reference tables,
 fascinating vintage supply catalogs, and more.

Gem & Jewelry Pocket Guide By Renee Newman GG

A traveler's guide to buying diamonds, colored gems, pearls, gold and platinum jewelry. Know what to look for when buying gems and what questions to ask jewelers. The Gem & Jewelry Pocket Guide offers tips on quality evaluation, fake and lab-grown gems, customs regulations, gem treatments, and geographic sources. Soft cover, 156 pages.

621.405 **\$17.85**

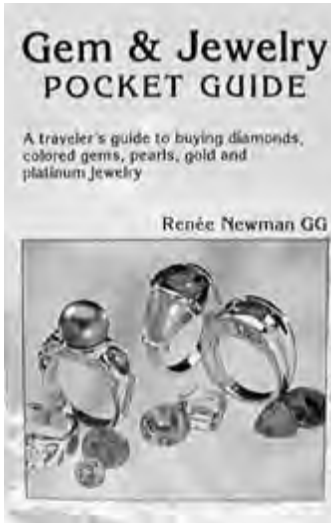

621.405

Jewelry & Gems: The Buying Guide

By Antoinette L. Matlins and A.C. Bonanno. With over 100 illustrations, it's a thorough, comprehensive, easy to understand layman's course in gem and jewelry buying. Valuable price charts, money-saving tips, a "how-to-know-what-you're-buying" book. Covers diamonds, pearls, precious and other popular gems. Soft cover, 213 pages.

621.411* **\$27.60**



621.411*

How to Repair Jewelry By Phelps - a professional jewelry repairman. Step by step instructions show how to fix chains, replace lost parts, rebuild prongs, remove and reset gemstones, solder without removing gems, size rings and much more. Also tells how to remodel old pieces. Color and B&W. 29 pages.

620.837 **\$9.25**



620.837

Jewelry Making for Beginners

Soukup. An easy to learn method for fabricating soldered jewelry pieces. All steps are clearly shown with photos and detailed text. Learn jewelry crafting with little investment of tools and no previous knowledge. 49 pages.

620.839 **\$4.95**



620.839

You Made It . . . Now Sell It!!!

The Ultimate Guide To Selling Your Handmade Jewelry by Susie Bradford Edwards. Everything you need to know before you make, sell or consign your jewelry to anyone. A source of expert guidance to help you enter today's hot and growing jewelry industry. Covers the opportunities and the risks to be found by making and selling your unique creations. Soft cover, 178 pages.

620.204 **\$21.95**



620.204

The Complete Metalsmith By Tim McCreight

Illustrated handbook describing everything from metals and their properties to tools and how to use them. Soft cover, 150 pages.

621.500* **\$22.50**



620.500

Gold, Platinum, Palladium, Silver & Other Jewelry Metals ~ How to Test, Select & Care for Them

by Renee Newman GG. Offers concise, practical details on precious metals. It also covers alternative jewelry metals such as copper, bronze, brass, stainless steel, titanium, Damascus steel and niobium. High quality color photos show how these metals are creatively used in jewelry. Besides providing a historical perspective and interesting facts about the metals, this book discusses jewelry manufacturing methods, plating and responsible mining and business practices. Soft bound, 136 pages.

620.205 **\$20.95**

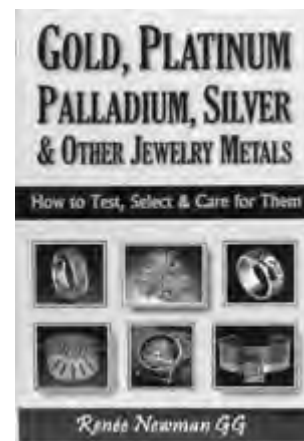

620.205

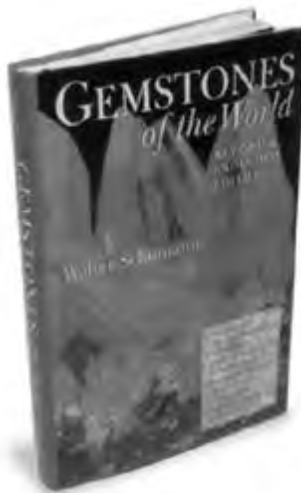

621.417*

Gemstones of the World By Walter Schumann

Authoritative reference work, with color photos of more than 1400 specimens, many shown before and after cutting. Technical data on gemstone properties, formation and structure of gems and cutting. Hard cover, 256 pages.

621.417*

\$35.45

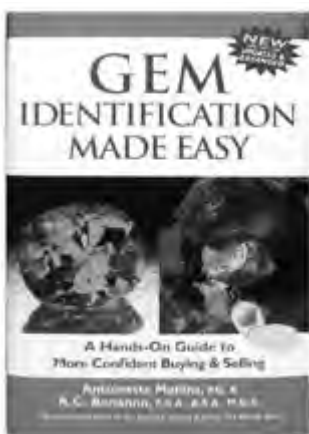

Gem Identification Made Easy

By Antoinette L. Matlins and A.C. Bonanno

A non-technical guide to diamond and gem identification using pocket, portable and laboratory instruments. Separate real gems from imitations. Hard cover, 270 pages.

621.412

\$51.00

Diamond Setting The Professional Approach

Robert R. Wooding describes the tools supplies and steps necessary for pin-point, prong (both round and fancy cut), bezel, channel, fishtail and bead settings. Hard cover, 178 pages.

621.450

\$29.95

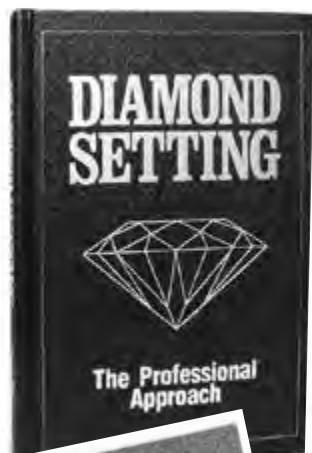

621.450

621.412

The Diamond Setting Manual

By Robert R. Wooding. Discussions and illustrations describe how diamonds are set in specific settings. Advance your skills with the diamond setting procedures and techniques detailed in this book.

621.447

\$62.50



621.447

Bead Setting Diamonds with Pavé Applications

By Robert R. Wooding. Detailed, well-illustrated instructions will assist the apprentice as well as the expert. Tools, bead setting procedures, applications and pavé setting. Hard cover, 192 pages.

621.449

\$38.15



621.449

Step-by-Step Bead Stringing By Ruth F. Poris

Describes basic tools, supplies and findings for bead stringing and describes in detail the techniques necessary to string multiple strands, endless strands and plain strands. Soft cover, 45 pages.

621.463

\$11.85



621.463

How to Thread a Bead Necklace

From Griffin, producer of high quality bead cord, this is one of the best instruction booklets on the market. It is filled with detailed illustrations and explanations. 32 pages.

630.192

\$6.50



630.192

The Encyclopedia of Beading Techniques

This book provides detailed, step-by-step instructions for a variety of techniques, all illustrated with more than 400 diagrams and photographs. Readers will learn both traditional and contemporary bead crafts, such as bead weaving, stringing, wirework, and strand-knotting. Practical projects reveal how to add detail, texture, color, and originality to garments and accessories. Hardcover, 160 pages.

630.013

\$30.75



630.013



620.000

The Best Little Beading Book

By Wendy Simpson Conner. A resource rich with thousands of illustrations. Includes step-by-step instructions for hundreds of projects, plus picture glossaries showing the differences between bead shapes and sizes, pliers, needles, stringing media and more. Chapters include: designing and constructing jewelry, making beads with polymer clay, fused glass, etc., Starting a jewelry making business, creating a portfolio, and lots more! Softbound, 274 pages.

620.000

\$31.75

Cas-Ker Jeweler's Bench

Our solid wood bench is well designed, extremely strong and reinforced, and it has a professional appearance for in-store use.

- Solid all wood top and all wood legs. No pressboard and no particle board.
- Full skirt and guard rails.
- Three utility drawers and a lined catch drawer.
- Pull-out tray with two shelves.
- Two arm rests and mandrel holes.
- Heavy duty and economically priced.
- Dimensions 39"H x 39"W x 19-1/2"D. Easily assembled.
- Bench ships via UPS Freight F.O.B. Cincinnati. Additional shipping charges apply.

131.071

\$349.00

130.302 Replacement Wood Pin for Bench 7" x 2³/₄" **\$4.25**



131.071

Hardwood Watchmaker's Bench

The watchmaker's workbench just got better - now available in gorgeous and durable hardwood!

- Organize your tools in 15 handy drawers.
- Catch bench sweeps in the 19" wide catch tray.
- Full-length sides and back.
- Sturdy and attractive enough for storefront use.
- Measures 39-1/4" x 21-1/2" x 39"
- Ships via UPS Freight F.O.B. Cincinnati. Additional shipping charges apply.

131.073

\$499.00



130.073

Maple Watchmaker's Workbench

Solid maple bench with maple veneer side and back skirts is suitable for storefront use. An ideal bench for jewelers, engravers, hobbyists, craftsmen and technicians as well as watchmakers.

- Eye level work area with large cushioned arm rests let you work with less fatigue.
- 8 side drawers and 2 wide center drawers.
- Dimensions 38"H x 48"W x 26"D.
- Weight 200 lbs.
- No assembly required.
- Made in USA.
- Ships via UPS Freight F.O.B. Cincinnati. Additional shipping charges apply.

130.048 Please call for price -1.800.487.0408 **\$1895.00**



130.048



130.051

Portable Mini Workbench sits on a tabletop

Mini Tabletop Bench features four drawers (one with lock and key), steel pan to catch filings, bench pin and a pull-out arm rest. Solid wood construction with guard rails and laminate top. The bench measures 20" x 16" x 10" high and weighs 25 lbs.

130.051

\$87.95



130.056

Watchmaker's Mini Workbench

Made for small spaces, this compact, portable tabletop workbench measures 20"W x 16"D x 10"H. The unit features eight small side drawers, one lockable center drawer and a center pull-out shelf. Side and back railing prevents items from rolling off. Solid wood with laminate top.

130.056

\$109.00



130.058

Solid wood ShelfMate keeps tools in easy reach

Give yourself more workspace with our bench top tool holder. Store pliers, shears and other tools so they're always within easy reach. Easy assembly. Burs, files, gauges . . . ShelfMate is ready to use and saves you time. Solid wood construction.

Measures 35"L x 7"W x 17"H.

130.058

\$54.45

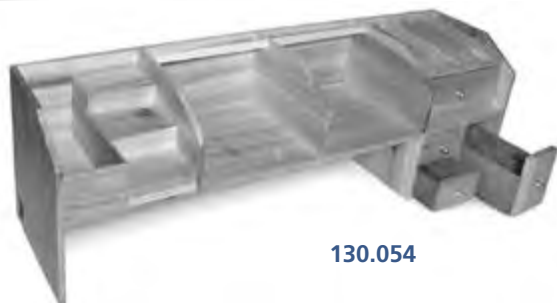

130.054

Deluxe Benchtop Organizer

Deluxe unit is made of solid hardwood and features two large bins, one deep bin, three 36 hole bur/drill holding blocks, six tool slots, and four drawers. Ready to use - no assembly required. Measures: 33 $\frac{3}{4}$ " L x 6 $\frac{1}{2}$ " D x 8 $\frac{1}{4}$ " H. 3/4" Slot in the back fits over standard bench trim to keep the unit in place.

130.054

\$62.95



130.052

Benchtop Organizer

Get your tools in order with a benchtop organizer. Wood grain laminate unit features four large bins that will keep any number of items close at hand. Ready to use - no assembly required.

Measures: 33 $\frac{3}{4}$ " L x 6 $\frac{1}{2}$ " D x 8 $\frac{1}{2}$ " H. 3/4" Slot in the back fits over standard bench trim to keep unit in place.

130.052

\$52.50



131.376

Wooden Pliers Rack with Drawer

Has slots for seven pliers, shelf for miscellaneous small tools and a handy storage drawer. With varnished natural finish. Measures 6" x 5" x 7 $\frac{1}{2}$ ". India.

131.376

\$27.30

Find more plier stands and organizers on page 170. Bench Pins & Vises are on page 250 - 251.

Grobet USA™ Three-Bulb Bench Lamp

Three fluorescent bulbs provide ample illumination on your workshop or desktop. The innovative design allows you to raise, lower or tilt, directing the light source quickly and efficiently onto your work.

- Floating-arm design requires only a slight touch to adjust.
- Energy-saving, compact lamp clamps to your bench or table.
- Three T5, 14W Fluorescent Bulbs.
- Electronic Ballast 220-240V AC.
- Arm 36"L, Head 24"L x 4½"W.

131.110

\$79.95



131.110

Dazor 2-Tube Floating-Arm Bench Lamp

Mirror finish reflector provides 30% more light output. Push, pull, tilt or swivel the 43" arm for soft, glareless lighting exactly where you need it. Rugged all-metal construction with dove gray baked enamel finish. Universal base allows horizontal or vertical mounting. Cool white bulbs included.

130.133 Lamp with 2 Tubes

\$249.00

130.136 On/Off Switch

\$20.50

130.137 Light Socket

\$19.50

130.017 Ballast for 130.133

\$26.75

130.154 Lamp with 3 Tubes

\$279.00

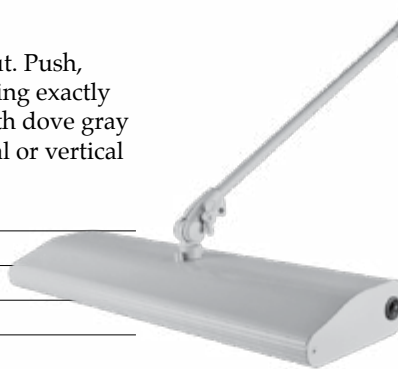

130.133
130.154

Dazor All-Purpose Illuminated Circline Magnifier

Provides even, uniform, shadow-free light under the magnifying lens with a 22 watt circline fluorescent bulb (included). Enhances color contrasts without competing shadows. 5-inch crown optical glass lens produces sharp images over a wide viewing area. Magnification power of 3-diopters (.75X). The Dazor "floating-arm" stays in place yet lets you position the light with a touch of your finger. Baked enamel finish, metal construction with adjustable clamp-on base.

130.102

\$299.00



130.102

ARBE 55 Watt Jeweler's Task Lamp

Simply designed to be the best task lamp for bench jewelers and diamond setters. Lightweight silver finish extruded aluminum body construction with fully positional articulating arm.

- 55 Watt European style bulb rated @ 6500K. Fluorescent light diffuser enables balanced light distribution and added protection.
- Dual mounting configuration standard.
- Made in USA.

130.135

\$154.95

Compact fluorescent tube for ARBE Task Lamp 130.135.

LUMILUX® Cool Daylight, 4-pin base. OSAM DULUX L 55 Watt/865 2G11.

130.135.B

\$29.95



130.135

Classic Dazor Desk Lamp

Provides abundant light over a large work area.

The 33" adjustable "floating-arm" is easily positioned with a touch of the finger. Rugged construction has no exposed wires or springs. Weighted base measures 9¾" x 6½" x 2". Comes with 2 daylight fluorescent tubes. 5 year warranty. Black. Additional shipping charges apply. Cannot be shipped via air.

130.118

\$242.50



130.118

Light color temperatures are measured in degrees Kelvin (K). Lower color temperatures (3,000K-4,000K) create reddish, warm light. Higher color temperatures (5,000K-6,000K) create bluish, cool light.

130.115



LED Lamp

Better directional lighting, produces less glare, directionality allows for precision lighting with no wasted light. Sleek and contemporary task lamp frame incorporates the newest LED lighting technology.

- 144 LED bulbs provide 3200 lumen output
- Dimmable
- 6000-6500K perfect for diamond grading
- 110V-230V
- 80 watt equivalent, only consumes 30 watts

130.115

\$199.95



131.116

LED Table Top Inspection Lamp

Bright LED lights reduces eyestrain with a pure and cool light and 1 3/4x magnification. Features a movable arm and a flip cover over the magnifier for when not in use. No-tip weighted base.

131.116

\$75.00



130.125



Cool-White Flexible Lamp with 5X Magnifier

- 5X magnification for easy work with small parts and detailed projects.
- 3/4" lens, 6 1/2" lens diameter.
- Cool-white light renders colors perfectly to the user's eyes and reduces eye fatigue.
- Flexible gooseneck lets you adjust the lamp to various positions.
- Heavy metal non-slip base for stability.
- Excellent for jewelry, bead stringing, watchmaking and hobbies.

130.125

\$38.50



131.128

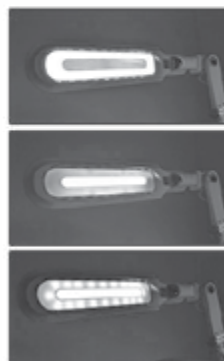

LED Lamp with Double Bench Clamp

This stylish 600 lumen LED lamp is a perfect fit for your workbench.

- Adjustable color temperature: Soft white, Bright white, Daylight
- Full range dimmer
- Dimensions: 20"L x 6"W x 22"H
- 10 watts
- Touch switch
- Comes with both bench clamp and base stand

131.127 Black

\$99.00

131.128 Silver

\$99.00

BAUSCH & LOMB Single Lens Loupes

Feather-light frames with soft black interior surfaces. Lenses are carefully ground and polished from the best optical glass.

Number	Power	Working Distance	Price
290.130	10X	1.0"	\$16.95
290.131	7X	1.5"	\$16.95
290.132	5X	2.0"	\$16.95
290.133	4X	2.5"	\$16.95

BERGEON Plastic Loupes

Swiss made loupes in three magnifications. At this price you can keep a set of all three to adapt to individual jobs. Bergeon 4422.

290.442	4.0X	2.5"	\$11.95
290.443	3.3X	3.0"	\$11.95
290.444	2.8X	3.5"	\$11.95

10X Triple Aplanatic

Best possible optical correction for no distortion or color blurring. Recommended for critical inspection. Working distance 1", 10X.

290.075			\$59.95
----------------	--	--	----------------

Single Lens Loupes

Ground, polished lenses in lightweight black plastic frame. India.

290.620	7.0X	1.5"	\$3.25
290.623	3.3X	3.0"	\$3.25
290.621	5.0X	2.0"	\$3.25
290.625	2.5X	4.0"	\$3.25
290.622	4.0X	2.5"	\$3.25

PEER® Double Lens Loupe

Provides two magnifications. Front lens screws off when not needed. Working distance 1.5" and 2.5", power 5X and 12X.

291.580			\$14.50
----------------	--	--	----------------

Swiss ASCO Loupes

ASCO is the standard brand for the Swiss watchmaking industry. Available in five different powers and focal distances.

290.911	10.0X	1.0"	\$25.95
290.912	6.5X	1.5"	\$22.95
290.913	5.0X	2.0"	\$22.95
290.914	4.0X	2.5"	\$22.95
290.918	3.0X	3.5"	\$18.50

ASCO Aplanatic Loupes

Top of the line Swiss watchmakers' loupes with blue tinted lenses that minimize the effects spherical aberration. Good for inspecting pivots - blue cancels out red in the light spectrum of jewels. Good for viewing diamonds.

290.915	10X	1.00"	\$107.95
290.919	12X	1.00"	\$112.00
290.916	20X	0.25"	\$119.95

ASCO Aplanatic & Achromatic Loupes

Swiss watchmakers' loupes with blue tinted lenses that minimize the effects of spherical and chromatic aberration. Good for inspecting pivots - blue cancels out red in the light spectrum of jewels. Good for viewing diamonds.

290.905	10X	1.00"	\$219.00
290.906	12X	1.00"	\$279.00
290.907	20X	0.25"	\$259.00



290.130



290.442



290.620



290.075



291.580



290.911



290.915



290.906



BERGEON

Bergeon 4x Watchmaker's Loupe

These loupes are made from a durable and lightweight synthetic and fitted with a metal rim. Magnification of 4x. Opening on the side prevents misting of the glass. Swiss made.

640.2611-TB	White	\$16.75
640.2611-TN	Black	\$16.75



ZEISS

290.705

ZEISS Optical Quality Folding Pocket Loupe

This small, convenient size, high-performance loupe from Carl Zeiss is a very powerful visual aid. The aplanatic-achromatic design of the lens system provides a field of view which is practically free of distortion and chromatic aberrations right into the peripheral zones. 10X with anti-reflective coating.

13mm diameter, 22mm field of view, 40dpt refractive power.

290.705	\$119.00
----------------	-----------------



291.608



Grobet LED Illuminated 20x Jeweler's Loupe

Stainless steel. 20x-21mm magnification.

291.608	\$6.95
----------------	---------------

Bausch & Lomb



290.242 - 290.244

B&L Pocket Coddingtons

Though only a single lens magnifier, it's special construction, with a grooved diaphragm around its circumference, gives a good, distortion-free definition of the object being viewed.

No.	Power	Working Distance	Price
290.242	10X	1.00"	\$44.50
290.243	14X	0.75"	\$48.80
290.244	20X	0.25"	\$53.95



290.260 - 290.263

B&L Pocket Hastings

A triplet lens system for correcting spherical and chromatic aberrations. Eliminates color degradation and puts every part of the wide field of view in sharp focus. One of the most highly corrected magnifiers available.

No.	Power	Working Distance	Price
290.260	7X	1.50"	\$46.95
290.261	10X	1.00"	\$71.60
290.262	14X	0.75"	\$84.40
290.263	20X	0.50"	\$84.40

Cas-Ker Hastings 10X Triplets

18mm folding oval loupes feature three individual lenses bonded together to form a compound lens resulting in very clear, distinct magnified image with no distortion or color aberration. Available in three finishes. Leather case included with each.

290.800	Chrome Loupe	\$10.95
290.801	Black Loupe	\$10.95
290.802	Gold Loupe	\$10.95
Three or more assorted		@ \$9.95 ea



290.800 - 290.802

290.041

NEW! Eschenbach Eyeloupes

Since 1903, Eschenbach has introduced novel and award-winning magnification solutions. Eschenbach German-made eye loupes with air hole to prevent condensation, available in 3x through 15x.

290.041	3x	\$19.95
290.042	5x	\$21.50
290.043	7x	\$22.50
290.044	10x	\$24.95
290.045	15x	\$33.95
Eschenbach German-made 10x folding magnifier. 23mm diameter.		
290.046	10x	\$49.95



290.046

Doublet Magnifier

Spaced doublet lenses provide distortion-free viewing. 10X.

290.660 \$11.50



290.660



290.664

290.654

20X Chrome Loupes

Folding loupes feature polished chrome finish, split ring for chain and leather case.

290.664	21mm - 20X Hexagon	\$15.50
290.654	18mm - 20X Round	\$14.25

21mm "Diamond Cut" 10X Triplets

Attractive, functional loupes have diamond cut impressions for a better grip. 10X lens is a triplet for good depth of field and minimal glare. Available in three finishes. Leather case included with each. 21.5mm

290.883	Black Loupe	\$15.95
290.884	Gold Loupe	\$15.95
290.885	Chrome Loupe	\$15.95



290.883 - 290.885

18mm "Diamond Cut" 10X Triplets

Attractive, functional loupes have diamond cut impressions for a better grip. 10X lens is a triplet for good depth of field and minimal glare. Available in three finishes. Leather case included with each.

290.880	Black Loupe	\$13.50
290.881	Gold Loupe	\$13.50
290.882	Chrome Loupe	\$13.50

290.880 - 290.882

10" is the approximate closest distance the human eye can comfortably focus on an object. Eyeloupes and magnifiers enable your eye to focus closer.

290.643



10X Loupe & Case

Small economical loupe folds to fit in your pocket. 10X lens. Leather case included. India.

290.643 **\$10.50**

290.024G



GemOro Rubber Grip

10X, 18mm, folding loupe features rubber grip. Gold finish. Precision Japanese lens. Includes leather case.

290.024G **\$11.50**

290.032G



GemOro Hexagon Rubber Grip

10X, 21mm, folding loupes feature rubber grips. Available in three finishes, including marble colors. Precision Japanese lenses. Leather case.

290.032BL Black/Rubber **\$20.95**

290.032G Gold/Rubber **\$19.25**

290.030BL



GemOro Hexagon

10X, 21mm, folding loupes with black lens housing and contrasting cover. Available chrome, gold, and blue. Japanese lenses. Leather case.

290.030BL Black/Black **\$20.50**

290.030C Chrome/Black **\$20.50**

290.020BLU



GemOro VIP LITE LOUPE® in Black, Pink & Blue

A prestigious loupe for the discriminating diamond professional. 10X Hastings triplet magnification and full 18mm viewable lens. Superior polished optical glass lens, achromatic, color corrected, aplanatic and distortion-free. Light weight ABS frame with stainless steel accent panels. Leatherette carrying case.

290.020BLK Black **\$20.50**

290.020P Pink **\$20.50**

290.020BLU Blue **\$20.50**



291.665



Vigor 10X Loupes

Folding loupes are each supplied with a leather case. 18mm lens, 10X. In 3 finishes.

291.665 Chrome **\$16.05**

291.666 Black **\$16.05**

291.667 Gold **\$16.05**

Ultra-Light Eyeglass Loupes for maximum comfort

These Donegan Optical loupes provide precision magnification on most any eyeglass frame. Lenses are high quality optical grade. Very lightweight and tough materials provide superior durability. Four changeable cams are included to fit eyeglass frames from 1/16" to 1/4" temple width. Eyeglass clamp easily converts from right to left temple mounting. 24mm lens diameter. USA.

Single Loupes

No.	Power	Working Distance	Price
290.714	7X	1.5"	\$25.25
290.715	5X	2.0"	\$25.25
290.716	4X	2.5"	\$25.25
290.717	3X	3.5"	\$25.25

Double Loupes

No.	Power	Working Distance	Price
290.718	5X, 7X	2.0" & 1.5"	\$30.75
290.719	4X, 7X	2.5" & 1.5"	\$30.75



290.714 -
290.717

290.718 -
290.719

Bausch & Lomb Spectacle Loupes

These quality loupes fit snugly on either wire or plastic eyeglass frames. Lens swings up when not in use.

B&L Single Lens Spectacle Loupes

No.	Power	Working Distance	Price
290.182	4X	2.5"	\$34.50



290.180 -
290.182



Adapters are included with B&L Spectacle Loupes for use with side shield safety glasses.

B&L Illuminated Pocket Coddington

A standard Coddington mounted on a handle which houses two penlite batteries (not included). Light shines through lens to illuminate object being viewed. Working distance 1", 10X.

290.268	\$49.65
----------------	----------------



290.268

Clip-on Spectacle Loupes

These clip on to your lens and flip up easily when not in use. 10X loupe may be used as a 5X by unscrewing the front lens. Black plastic frame. Coated tips won't scratch glasses.

290.200	10X Clip-on Loupe	\$14.95
290.201	5X Clip-on Loupe	\$13.50



290.200



290.651

Loupe with LED Light

Features attached LED light and three interchangeable lenses, 5X, 10X and 15X. Light adjusts to illuminate directly on an object and may be removed when not needed. Uses 3 button cells, included. Works best with a wire holder such as 290.546.

290.651

\$13.50



290.163

BERGEON Loupe Holder

Keeps your loupe firmly in place for extended wearing. Spring steel adjusts to fit any plastic loupe. Swiss. (Loupe not included)

290.163

\$40.95



290.546

BERGEON Wire Loupe Holder

Stainless steel spring holds any eyelooupe. Lightweight and comfortable. (Loupe not included) Bergeon 5461.

290.546

\$6.50



290.799
290.804

Rope Chain keeps your loupe close at hand

Rope chains are 30" long and have a large lobster claw clasp and a hook for your eyelooupe. Available in goldtone and silvertone (loupe not included).

290.799 Goldtone

\$5.50

290.804 Silvertone

\$5.50



290.165
290.166

Extra Long Loupe Chain

38" snake chain with lobster claw clasp and a hook (loupe not included).

290.165 Goldtone

\$6.50

290.166 Silvertone

\$5.95

Double Lens Magnifier

PEER Japanese spaced doublet lenses provide distortion-free viewing. One lens has a 1" working distance and 10X, other has a 1/2" working distance and 15X.

291.662 **\$28.15**



291.662

B&L Pocket Magnifiers

Two or three lenses can be used singly or in combination. Durable lightweight black plastic frames fold into attached case. Working distances from 1/2" to 3 1/2", depending on magnification.

No.	Lenses	Power	Price
290.281	3	5X, 7X, 9X	\$29.50
290.284	1	4X	\$17.95
290.286	2	4X, 5X	\$26.75



290.286

B&L Pocket Magnifier with attached Case

Lens is 2" diameter, 2X power, with working distance of 5" for reading and inspecting.

290.282 **\$19.75**

290.282



PEER® Pocket Magnifier in Leather Case

Economically priced magnifier. 3X power, diameter 1 3/4", working distance 3 1/2".

291.684 **\$16.30**



291.684

PEER® 10X Linen Tester

Not just for textiles, it can be used anywhere. 10X magnification, 1" working distance, 9/16" lens diameter and 1/2" square field. Folds flat.

291.570 **\$37.25**



291.570

Magnifier folds flat, travels easily

This magnifier has a large 75mm diameter glass lens with 5X power. Black plastic frame features inch and centimeter rules molded into the base. Approx. 4" square. Ideal for reading maps or any kind of small print or inspecting small objects.

290.309 **\$8.75**



290.309

290.308



Magnifying Thumb Attachment

5X magnifier fully adjustable to fit almost any finger and thumb.

290.308 **\$5.25**

Magnifying Scissors

Add 5X magnifying power to your favorite small scissors, or use the included scissors.

530.206 **\$6.50**



530.206

Tweezers with built-in Magnifier

Stainless steel non-magnetic 00 pattern Tweezers with strong points for a variety of uses at the bench. Plastic magnifier adjusts to focus on tips. 5" long overall.

570.012 **\$8.50**



570.012

291.915



Pull-out Lighted Magnifier

This pocket size magnifier features 2 lenses, a main 21mm lens offering 30X magnification and secondary 12mm lens with 60X magnification. Also features an LED light as well as a UV light for currency detection or fluorescents in stones. LED light comes on automatically when opened. Measures only 2½" x 1½" closed. Three LR113 batteries included.

291.915

\$11.05

291.910



30X Magnifier toggles between LED and UV Lights

This magnifier measures only 4" long and features a 30mm 30X lens magnification lens. It also features a toggle switch to go between LED and UV light, and an on/off switch for illumination.

- Two CR2016 batteries included.
- Comes with a small protective pouch.

291.910

\$10.50



Grobet Hand Held Magnifier with LED Light

- 40X Magnification
- Dual lens optics
- 21mm Lens Diameter
- Two LED lights
- On/Off switch
- Batteries not included

291.917

\$12.95

291.917

290.362

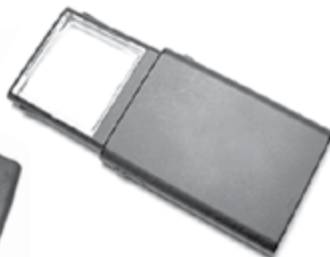

B&L Lighted Magnifier

Perfect for pocket, briefcase, purse. Stores in its own case. Push button to release, push again to turn on lamp. Batteries included. 2X, 2" lens.

290.362

\$10.50

290.360



B&L Packette Magnifier

The hard plastic cover snaps open, clicks shut and acts as the handle. Just slightly larger than a pack of matches. 2" Working Distance, 5X Power, Aspheric Lens

290.360

\$9.95

290.307



B&L Mini-Lite Magnifier

Handy 3½/2X magnifier with thumb-switch illumination for low-light subjects. Viewing area is 1¼" x 1¼". Durable black case measures 4¾" x 1½". Includes two AAA batteries and the bulb is replaceable.

290.307

\$11.75

Emerald Filter

A most valuable aid in distinguishing genuine emeralds from the pastes and doublets which resemble them. Filter combination is primarily intended for emeralds, but is also useful in identifying synthetic blue spinel, cobalt-glass sapphire imitations, natural and synthetic ruby. The most successful filter of its kind.

290.013**\$41.95**

290.013

10X LED LightLoupe®

If you are looking for a really handy tool for viewing diamonds, gems and jewelry under super bright LED illumination, our 10X LED LightLoupe is a dream come true and a must buy for those who want the best tools of the trade. This portable gemological tool uses a high quality 10X, 21mm magnifier lens with a built-in LED light source. Includes a carrying case, batteries and screwdriver.

290.035**\$9.95**

290.035

Magnetic Flexible Light

Versa-Light is a super bright LED light which clamps to a flexible arm with a magnetic base. One light - so many uses! Ideal for use on polishing machines, drill press, bench accessories. The strong magnetic base stays secure on metal surfaces for hands-free illumination. Zoom in to pinpoint light onto small items and zoom out for a wider view.

- Push button switch has three settings: High Beam, Low Beam and Flash.
- 8½" Flexible Arm adjusts to aim light exactly where you need it.
- Sturdy Clip holds light in place.
- Heavy-duty 1½" Magnetic Base.
- 1 x 2000 Light Zoom.
- Includes 3-AAA batteries.

130.388**\$26.95**

130.388

iView Handheld LED Illuminated Magnifier

This magnifier has many uses: professional jewelry inspection and selling tool, diamond and gemstone fluorescence detection, low-vision reader, counterfeit bill and credit card identification and circuit board QC.

- Dual 5X & high 10X magnification.
- Crisp 55mm and 20mm optical quality lens.
- 8 Super bright white natural daylight LED's and 1 UV LED.
- Ergonomic high-tech design. 7½" long, 3¾" diameter.
- Includes 3 AAA batteries & protective carrying case.

290.315**\$20.95**

290.315



290.652



Detachable 10X Lighted Magnifier with Maglite

The best illumination yet for viewing stones and other small objects. Attached directly to the maglite is a 10X color corrected compound triplet magnifier made of a high impact nylon composite with rubber eyepiece. The magnifier features a diffuser and one-way reflector so that the viewer's eye is directly above the light giving the best possible view of diamonds, gems, etc., where accurate viewing is necessary.

290.652

\$46.95



291.650

PEER® Measuring Magnifier with Flashlight

Spaced doublet lens gives good definition of object being viewed. Removable inch and millimeter scales are viewed through lens for making accurate measurements. Light shines through lens to illuminate object. Operates on standard C-cell batteries (not included). Lens diameter 1 1/4", working distance 1 1/2" and power 7X. Overall length 6 3/4".

291.650

\$32.95



291.695

PEER® Pocket Scope

This microscope has a decimal inch scale inscribed on the lens. Only 4 1/2" long and 7/16" in diameter.

No.	Power	Length	Divisions	Price
291.695	40X	.070"	.001"	\$35.95

131.166

Penlight

Rugged, clear-coat, aluminum flashlight is designed for years of dependable service. Includes 2-AAA batteries and storage tube.

131.166

\$9.45

Did you know?
You can
FAX
your order!
1-800-487-5848

Call or fax by 3:00PM
Your Local Time
(Mon-Thurs)
for Overnight Delivery
1-800-487-0408 P
1-800-487-5848 F



291.916

Magnifier with Interchangeable Lenses

Three interchangeable lenses give you 2.5X, 5X, or 16X magnification. Two LED lights. Grobet.

291.916

\$15.95

B&L Rectangular Reader

Scientifically designed, lightweight, 2X aspheric lens assures edge-to-edge clarity. The 2" x 4" lens is mounted in the ergonomically designed handle which conforms to the shape of the hand.

290.300 **\$15.25**



290.300

B&L Folding Illuminated Magnifier

Built-in light powered by two AAA batteries, included. Handle swings open for use. 2" x 4", 2X power aspheric lens for clarity. Includes soft carrying case.

290.301 **\$36.50**



290.301

Flex-A-Mag

Ideal for workbench, desktop, or table. 5X power magnifying lens on a flexible-neck and a sturdy plastic base for hands-free viewing.

291.712 **\$39.20**



291.712

3.3X Magnifier on Stand

Heavy base prevents movement and multi-position swivel clamp permits adjustment for best viewing. 3.3X magnification.

291.71010* **\$17.50**

291.71011* Replacement Glass **\$6.95**



291.71010*

Magnifier Lamps *page 314*

OptiVisor Professional Series Set

Complete OptiVisor Set includes Headband, Six Lenses, OptiLoupe and VisorLight . . . all packed into an impact resistant secure storage case. Dial adjusting headband fits any size. Well made magnifier made of light, durable material. Fits over eyeglasses. Adjustable pivot assembly on visor can be set to desired tension to stay in place when tilted. Six different Lens Plates with ground, polished prismatic lenses for wide angle viewing. OptiLoupe for close-up inspections. Laser Spot Xenon VisorLight puts direct light on your work surface (requires two AA batteries, not included).



Set includes safe storage box.



290.724

290.724 Complete OptiVisor Set **\$265.00**

290.480 OptiLoupe fits on either side, adds 2½X **\$12.95**

290.372 VisorLIGHT Xenon Laser Beam 6000 candle power **\$28.95**

290.374 Replacement Bulb **\$7.95**

290.550 Replacement Sweatband for OptiVISOR **\$14.25**



290.372



290.480



290.562

Headband Magnifier puts light where you need it

LED Lighted Head Visor Magnifier features four different power lenses. Perfect for crafts, hobbies, repairs, reading and all hands-free observation. Lenses that quickly snap in and out of the visor.

- Four interchangeable lenses: 1.5X, 2.0X, 2.5X and 3.0X.
- Lenses have a hardened surface treatment and flip up for normal viewing.
- One size fits all fully adjustable head strap. Lightweight and comfortable.
- Removable LED lamp can be used as a free standing light source.
- Magnetic lamp base can be attached to metal surfaces.
- Light adjusts to aim directly on work. Requires 3-AAA batteries, not included.

290.562

\$35.25



291.561

Headband Magnifier has dual lights, four powers

Four magnifications built in. No additional lenses to buy. Glare proof design. With the use of a flip down inner lens and the auxiliary loupe, a range of magnifications from 1³/₄" to 4³/₄" is possible, 10" to 3" working distance. Lights on both sides (requires 2-AAA batteries not included.)

291.561 Magnifier with lights

\$58.80

291.560* Magnifier without lights

\$45.95

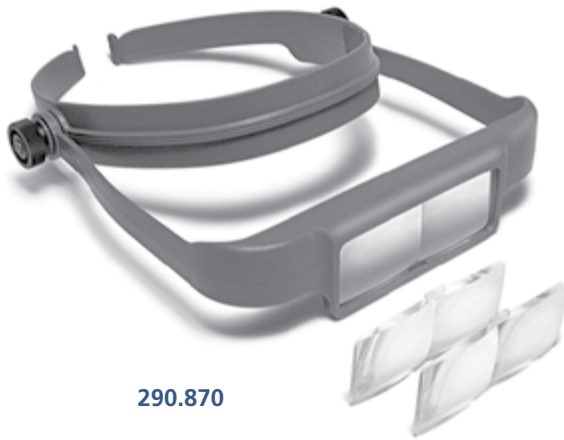

290.870

OptiSIGHT™ Visor

This Donegan Optical visor provides lightweight magnification and conforms to a perfect fit. Easy to use and loaded with features:

- Supplied with three different lens plates: 1.75X at 14" viewing distance, 2X at 10" and 2.5X at 8".
- Lightweight, durable, impact-resistant.
- Visor can be worn over prescription or safety glasses.
- Brings work closer into focus, reducing eye strain and fatigue.
- Optical grade acrylic lenses. Visor design shields out glare.
- Made in USA. Available in six different colors.

290.870.2 Grey

\$32.95

290.870.3 Red

\$32.95

290.870.11 Green

\$32.95

290.870.12 Purple

\$32.95

290.870.13 Blue

\$32.95

290.870.14 Beige

\$32.95



290.563

Magnifier With LED Light

- Comfortable lightweight frame with adjustable 2-bulb LED light
- Five interchangeable acrylic lenses: 1X, 1.5X, 2X, 2.5X and 3.5X
- Comfortable elastic headband for extended use and secure fit
- Includes storage case for lenses
- Uses three LR1130 batteries (included)

290.563

\$14.95

Clip-On Telesight Magnifiers

Acrylic coated lenses can be replaced with your prescription by your optical provider. Lightweight, optical quality frames clip to your eyeglass frames or to the included frame. Flip up when not in use.

No.	Style	Working Distance	Power	Price
290.740*	23	14"	1 ³ / ₄ X	\$33.95
290.742*	25	9"	2 ¹ / ₄ X	\$33.95
290.743*	26	7"	2 ¹ / ₂ X	\$33.95

Full Frame Telesight Magnifiers

Optically ground prismatic lenses designed for normal convergence to prevent eye strain. Front lenses flip up when not in use. Your own prescription lenses can be used in full frame.

No.	Style	Working Distance	Power	Price
290.752	33	14"	1 ³ / ₄ X	\$33.95
290.753	34	11"	2X	\$33.95
290.754	35	9"	2 ¹ / ₄ X	\$33.95
290.75401*	36	7"	2 ¹ / ₂ X	\$33.95
290.75402*	38	5"	3X	\$33.95

Half Frame Telesight Magnifiers

For those who do not wear glasses. High quality prismatic lenses in lightweight frames attached to half-eyeglass frames. Front lenses flip up when not in use.

No.	Style	Working Distance	Power	Price
290.760	43	14"	1 ³ / ₄ X	\$33.95
290.761	44	11"	2X	\$33.95
290.762	45	9"	2 ¹ / ₄ X	\$33.95
290.763	46	7"	2 ¹ / ₂ X	\$33.95
290.764	48	5"	3X	\$33.95

Clip-On Opticaid Magnifiers

Clip on to any eyeglass frame to leave hands free. Optically designed plastic lenses enable you to see tiny details, without distortion, using both eyes. Lightweight, comfortable and adjustable. Comes with carrying pouch.

No.	Style	Working Distance	Power	Price
291.774	2	20"	1 ¹ / ₂ X	\$31.55
291.770	3	14"	1 ³ / ₄ X	\$29.95
291.771	5	8"	2 ¹ / ₄ X	\$31.55
291.772	7	6"	2 ³ / ₄ X	\$31.55
291.773	10	4"	3 ¹ / ₂ X	\$44.25

Clamp-on Eyeglass Magnifier

An excellent value for eyeglass wearers. 2.5X. Lightweight, comfortable and excellent quality optics. The hinged lens plate and supporting arm are freely adjustable for viewing without eye strain. Spring clip fits practically all spectacle frames. Swiss made.

290.731 **\$28.50**

Flip-up Eyeglass Magnifiers

Magnifier clips to practically any eyeglasses and flips up for normal viewing. Add 2.0, 2.5 or 3.0X magnification to your spectacles. Lightweight and comfortable. Protective case included.

290.1000	2.0X	\$13.75
290.1001	2.5X	\$13.75
290.1002	3.0X	\$13.75

**290.740* -
290.743***



**290.752 -
290.75402***



**290.760 -
290.764**



**291.770 -
291.774**



290.731



**290.1000 -
290.1002**



290.470 - 290.475



Donegan Optical

OptiVISOR lets you enjoy clear magnification in complete comfort

Dial adjusting headband fits any head size. Well made magnifier made of light, durable material. Fits over eyeglasses. Adjustable pivot assembly on visor can be set to desired tension so it will stay in place when tilted. Lenses are ground, polished prismatic type.

OptiVISOR

Cas-Ker Number	Mfr. No.	Power	Working Distance	Price
290.470	DA-2	1 ¹ / ₂ X	20"	\$54.95
290.471	DA-3	1 ³ / ₄ X	14"	\$54.95
290.472	DA-4	2X	10"	\$54.95
290.473	DA-5	2 ¹ / ₂ X	8"	\$54.95
290.474	DA-7	2 ³ / ₄ X	6"	\$54.95
290.475	DA-10	3 ¹ / ₂ X	4"	\$54.95

Lens Only

Lens Number	Mfr. No.	Power	Working Distance	Price
290.485	LP-2	1 ¹ / ₂ X	20"	\$32.00
290.486	LP-3	1 ³ / ₄ X	14"	\$32.00
290.487	LP-4	2X	10"	\$32.00
290.488	LP-5	2 ¹ / ₂ X	8"	\$32.00
290.489	LP-7	2 ³ / ₄ X	6"	\$33.95
290.490	LP-10	3 ¹ / ₂ X	4"	\$33.95



291.568

Grobet 2-LED Headband Magnifier

Illuminating headlamp with attachable magnifier. Comes with 11 different magnification sizes and a storage box. Dial adjusting headband fits any size. Well made magnifier made of light, durable material. Fits over eyeglasses.

291.568 **\$19.95**

Grobet 2-LED Headband Magnifier

The 2-piece adjusting band makes this headlamp easy to wear and adjust quickly.

291.569 **\$21.95**



291.569

Grobet HD Digital Microscope

Easy to use HDMI Digital Microscope with 1080p video output. Top quality image sensor and corresponding glass microscopic lens for stunning full HD images. Can be used with a PC or TV with included HDMI cable or save images on a Micro-SD card (not included).



- 3 Mega Pixels
- Manual focus from 10mm to 500mm
- 10x to 220x magnification
- 8 LED adjustable light source

291.905 **\$239.00**

Cas-Ker Stereo Gemscope

Our Stereo Gemscope is an outstanding value, offering you professional capabilities at a great low price. It incorporates the finest high resolution optics for crisp imaging and excellent depth of field, and upper and lower halogen illumination for the best possible viewing. Our scope is quality built to provide years of service. An invaluable tool for buying and selling gems.

- 10X and 30X stereo magnification with turret style quick-change and precision rack and pinion focusing.
 - Darkfield attachment displays minor flaws in diamonds.
 - Professional Darkfield/Brightfield illumination controlled by a shutter.
 - Lower light width is controlled by an adjustable iris.
 - Widefield 10X eyepieces with rubber eyecups.
 - 45° inclined binocular body and 360° rotating head allows clerk and customer counter use.
 - Extremely durable for increased stability.
- Integral solid post prevents vibration.
 ● Smooth operating and easy to use.
 ● Includes gemstone holder and dust cover.
 ● Warranty: Five year mechanical and Three year electrical (including bulbs).

290.221

\$309.95



10X Eyepieces with Rubber Eyecups

360° Rotating Head

1X & 3X Turret Objective

290.221

Accessories for Cas-Ker Stereo Gemscope 290.221

Gemstone holder

290.230 \$58.50



Rubber Eyecups

290.227 \$11.50 pr



Darkfield attachment

290.228 \$85.95



10X Eyepieces

290.226 \$54.95 pr



Turret Locking Screw

290.229 \$3.25



Halogen Bulb

290.225 \$8.95



Digital LCD Portable Microscope

See between 10x - 220x magnification with this high definition digital microscope.

With the ability to capture both images and video, this microscope is perfect for jewelry craftsmen and appraisers. The 3.5" HD display has a 3-megapixel image and can support TV output. Use the rechargeable 3.7v lithium battery and the unit is small enough for traveling, measuring only 5.9" x 4.1" x 9". Comes with an SD card for storing images and videos, or use the included USB connector.

291.900
\$259.00



291.875

Grobet Gemological Microscope with 20X & 40X magnification

Grobet's microscope offers professional capabilities at an affordable price.

- 20X and 40X stereo magnification with precision rack and pinion focusing.
- Built-in light and darkfield illumination.
- View set and unset stones.
- Equipped with pillar stands and top and bottom lights.
- 10X eyepieces with rubber eyecups.
- 45° inclined binocular body and 360° rotating head allows clerk and customer counter use.
- Includes stage clips, gemstone holder and dust cover.

291.875

\$299.95



290.202

GemOro Elite 1030 Scope for Watch Service Technicians

Ideal for watchmakers, this scope has a flat work surface to accommodate watches of all sizes. The frosted plate allows lower light through and the opaque black/white plate may be used when only upper light is needed.

- Superior Japanese quality optics with 10X & 30X magnification.
- Includes a frosted glass viewing plate and an acrylic black/white reversible viewing plate.
- 3 lighting positions (upper, lower and combined.)
- 360° rotating head.
- Comes with a small parts holder, eye guards and dust cover.
- Internationally adaptable 100V-240V multi-voltage, automatically adjusts to each country's specific power.
- 5-year mechanical warranty and a 2-year electrical warranty included.

290.202

\$279.95



Universal Scope Dustcover

290.224

\$28.50



Darkfield for Meiji Scope

290.999F*

\$109.95

Bulbs for GemOro, Southern Precision and Meiji



Incident-transmit top bulb for Meiji.

290.233 \$26.50



Meiji Lower transmitted MA561.

290.901 \$18.50



for GemOro Elite Precision.

290.232 \$7.95



for Gemoro Elite 745 Zoomscope 6V20W.

290.239 \$22.95



Lower Bulb for GemOro II and older GemOro.

290.195 \$6.95

Clear Ultraspec 2000 Safety Glasses

Made with 100% polycarbonate 4-C coating on both sides of lenses, providing anti-fog, anti-static, anti-scratch properties and anti-UV up to 385nm. Clear lenses. OSHA approved and meets CSA Z 94.3 standards.

290.367 **\$8.95**

Clear Wrap-around Safety Glasses

Durable high quality, polycarbonate lens is highly resistant to impact. One-piece lens provides better visibility without obstruction. Soft comfortable nose pad, black plastic frame.

291.011 **\$12.95**

U.S. Safety Glasses - Aspen Style

Comfortable, lightweight with clear glass and polycarbonate sides that shield for increased safety. Will fit over most standard frames. Meet ANSI Z 87.1 requirements.

291.009* **\$11.60**

Safety Goggles

Helps protect eyes while buffing, grinding or doing other jobs with potential eye hazards. Vinyl plastic, ventilated frames with one-piece clear plastic lenses. Fits over eyeglasses.

291.371 **\$7.35**

Infra-Dura 9162 Welding Glasses

Made of propionate material. Fits over virtually all prescription and plano safety glasses. Adjustable fit through inclination mechanism on temple. Shade is 5.0 green.

291.369 **\$28.40**

Safety Glasses protect you while soldering platinum

These glasses have #7 lenses, preferred for soldering platinum. Glasses are black, lightweight plastic, very comfortable with adjustable earpieces and replaceable polycarbonate lenses. Platinum Guild and CE approved.

290.450 **\$11.50**

Cricket 9180 Welding Glasses

Adjustable ratchet hinge frame with polycarbonate green lenses. Frame uses Infra-Dura 3.0 lenses with universal nose bridge. Anti-fog, anti-static, improved scratch resistance, excellent UV absorption, and resists chemicals. Meets ANSI Z 87.1 and CSA Z 94.3 standards. Made in USA.

291.368 **\$28.70**

Disposable Anti-Fog Face Masks

Face mask with wraparound eye shield protects against particles. Inner and outer facings offer a soft protecting barrier while assuring comfort and breathability. Filters particulate matter at 99% efficiency. Pack of 25.

290.375 **\$11.75**

Face Shield

Lightweight plastic provides full face coverage. Pin and hole adjustment bands with cushioned vinyl sweat band.

291.376 **\$34.65**

291.377* Replacement Visor **\$11.10**



291.011



290.367



291.009*



291.371



290.450



291.369



291.368



291.376



290.375



230.250

101.3572
101.3573

Guard-Tex saves your fingers from cuts and abrasions

Self-adhering safety tape is made from surgical grade cotton gauze coated with natural latex rubber. Handle small articles much better than with cots or gloves. Sticks only to itself, not to your skin, yet breathes and actually improves your grip. Easily removed and leaves no gummy residue. Great for jewelers. Green color. Rolls are 90' x 3/4".

230.250

\$6.95/4 Rolls

3M™ Vetrap Finger Protection

Natural latex sticks to itself, not to your skin. It protects skin from burns and abrasions and provides excellent gripping ability for small workpieces. This wrap is light and durable. Individual roll 2" Wide x 5 Yards. Available in 2 colors.

101.3572 Green

\$3.45

101.3573 Blue

\$3.45

Leather Apron resists heat and cuts

Tough, heavy-duty side split cow leather provides superior heat and abrasion protection. Ideal for platinum soldering. Adjustable straps with quick release buckles. D-Rings. Bib style 24" x 30".

170.837

\$48.00

Denim Apron

The perfect shop apron. Constructed of heavy duty 12oz blue denim with grommets and tacked-on ties. Measures 28" x 36". Comes with a convenient 2-part bib pocket.

170.847

\$9.95

Respirator

MSA Advantage protection against a variety of respiratory hazards. Maintenance-free, easy to change filter. Flexible sealing surface to fit facial contours. Storage/disposable bag. Faceplate and cartridges are incinerable. Includes instructions and technical info. Order respirator and cartridges separately.

471.4000* Faceplate only

\$34.50

471.4110* Filter Cartridges

(type H-approval #TC-21C-600)

\$22.95

471.4120* Pair of Chemical Cartridges

(type GMC-approval #TC-23C-1278)

\$36.50

471.4130* Pair of Chem/Filter Cartridges

(GMCH-approval #TC-23C-1283)

\$56.50

Jewelry Shield™ shields sensitive skin from jewelry irritation

Jewelry Shield forms a transparent barrier that prevents annoying skin irritation, itching or ugly discoloration. By brushing transparent solution onto jewelry and metal accessories, you create an invisible shield protecting sensitive allergy-prone skin. Gives your customers unlimited personal choice in jewelry selection. Use on all skin-irritating metals; rings, earrings, bracelets, eye-glasses. Blister packs retail for \$5.99 each.

830.004 12pc Display Unit

\$49.95

830.005 1/2 oz Bottle Blister Pack

\$4.75 ea 12@ \$4.25 ea

Bausch & Lomb Pre-Moistened Tissues keep lenses clean and safe

Sight Savers® combine convenience of individually tissues with special surfactants to clean all glass and plastic lenses.

290.062

\$13.25/100



170.837



170.847



471.4000*



830.004



290.062

Instead-A-Glove Skin Shield

Skin barrier coat protects hands from substances such as solvents, epoxy, silicone, grease, oil, paint, fiberglass, inks, superglue, PVC adhesives, dirt, grime, magic marker, oil-based clay and more! No need to wear hot, sweaty rubber gloves. 100% Biodegradable glycerine based, like fine beauty products. Protects all day until you rinse it off with water. 4 oz., replaces 150 gloves.

220.903 **\$10.95**



220.903



230.007

pr88 Wash-off skin protection in a jar

Protects your hands against grease, oil, paint, varnish, resin, paste, fiberglass, tar, soot, dust, etc. Simply rub on hands before dirty jobs and rinse off with water. Long lasting, non-allergenic, safe and economical. German made. 3.5 oz jar.

230.007 **\$9.95**

Swiss made Nitrile Synthetic Rubber Finger Cots

Copolymer cots for watchmaking, electronics or chemical work.

230.219 Small **\$3.25 dz**

230.221 Medium **\$3.25 dz**

230.222 Large **\$3.25 dz**

Cotton Finger Cots

Soft stretch cotton provides comfortable protection during jewelry and watch finishing operations. Snug fitting - stay on your fingers.

230.218 **\$6.95 dz**

Spit Leather Finger Guards

Full length with superior wrap-around style and elastic comfort back. Maximum protection for all jewelry making operations.

471.526 Open End Finger **\$17.65/10**

471.527 Open End Thumb **\$17.65/10**

471.528 Closed End Finger **\$22.15/10**

471.529 Closed End Thumb **\$22.15/10**

Rubber Finger Cots

Made of soft molded red rubber to provide comfortable protection from oil, dirt and grime. Sold by the dozen.

231.225 Small **\$10.45 dz**

231.226 Medium **\$10.45 dz**

231.227 Large **\$13.05 dz**

231.228 Extra Large **\$9.85 dz**

Latex Gloves keep hands clean and safe

Strong, stretchable latex, disposable hygienic gloves provide fingertip sensitivity and non-slip grip. Go from bench to counter with clean hands. Wear when piercing ears. Ideal for keeping hands clean while polishing.

170.107 Small **\$9.95/50 pr**

170.101 Medium **\$9.95/50 pr**

170.104 Large **\$14.25/50 pr**

Atlas Nitrile Assembly Gloves

Nitrile palm coat for maximum flexibility, outstanding grip and puncture resistance. Snug fit for precise operations requiring maximum dexterity such as small parts handling and light fabrication. Seamless, lightweight nylon liner allows hands to breathe. Protects sensitive parts from contamination.

170.501 Small **\$6.25 pr**

170.502 Medium **\$6.25 pr**

170.500 Large **\$6.25 pr**

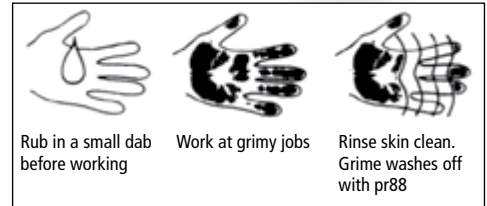

Rub in a small dab before working

Work at grimy jobs

Rinse skin clean. Grime washes off with pr88



230.219 - 230.222



230.218



471.526 - 471.529

231.225 - 231.228



170.107
170.101
170.104

170.501
170.502



150.007

Genuine BERGEON Case protects and organizes your valuable watch parts

Sturdy plastic case contains 23 clear plastic jars with lids for storing a variety of small parts. Each jar has its own compartment so they stay put in the case, offering even more protection. Case measures 10" x 4" x 1" and is made to stack neatly.

Swiss made. Bergeon 6088-D.

150.007

\$32.95 ea 5 @ \$29.50 ea



150.005

Aluminum Parts Case

20 plastic boxes with see-thru lids for small parts storage. Hinged lid case is 6 1/2" x 5 1/4" x 3/4". Boxes are 1 1/16" x 1 1/4" diameter. India.

150.005

\$5.50



150.590

Case stores and protects your parts in eighteen aluminum containers

Our handy storage case keeps your delicate watch parts safe. Hinged lid wooden box measures 13 1/2" x 7 1/2" x 1 1/2". Large aluminum containers have clear glass tops for easy selection and measure 2" in diameter x 7/8" deep.

150.590

\$19.95



150.118

150.119*

Cas-Ker Parts Tins

These are the round metal tins we use to ship your delicate watch part to you. Very sturdy and great for storing parts, too. 1 3/4" diameter x 1/2" deep. Pack of 25.

150.118

\$10.95

Round Metal Boxes

Made of tin. Perfect for storing small stones. Sizes in millimeters.

No.	Diam.	Height	Pack	Price
151.119*	46	18	72	\$89.95
151.127*	57	21	144	\$164.95



151.108



151.112

Screw Top Glass Bottles

Ideal for storing small parts. 18 x 30mm.

151.108

\$17.15 dz

Plastic Bottles with Plastic Tops

Perfect for storing parts. By the dozen.

151.112 12 x 31 mm

\$6.65 dz

151.113 16 x 38 mm

\$5.55 dz

Space-Saving See-Thru Trays

Convenient plastic trays for storing small parts, beads, stones or other small objects. Each tray has a threaded bottom which securely screws to the tray below it allowing access to any tray at any level.

- 150.154** Set of 5 - 2" diameter **\$3.95**
150.155 Set of 7 - 1 1/2" diameter **\$2.95**

Movement Trays

Set of 5 clear stacking trays for material with a round section that will hold up to an 18 size movement plate. USA.

- 150.146** **\$10.50**

Square Boxes

Clear plastic boxes are great for storing parts safely.

- 150.130** 1" x 1" x 3/4" **\$.55**
150.131 1" x 2" x 3/4" **\$.65**
150.132 2" x 2" x 3/4" **\$2.55**

Plastic Boxes with Compartments

For storing abrasives, small parts and mandrels.

No.	Dimensions	Sections	Price
150.135	4 1/2 x 2 3/4 x 1 1/8"	4	\$5.25
150.136	4 3/8 x 2 5/8 x 1"	6	\$4.50
150.137	8 1/4 x 4 1/4 x 1 1/4"	12	\$8.50
150.139	10 3/4 x 6 3/8 x 1 3/4"	18	\$14.25
150.140	8 1/4 x 4 1/8 x 1 1/4"	18	\$8.95

Large Hinged Lid Storage Box

Great for organizing and storing large watch parts, findings, beads, etc. Clear acrylic box measures 13" x 8 3/4" x 2 1/4", with 24 compartments measuring 2 1/8" x 2 1/8" x 2" Deep. Hinged lid.

- 150.050** **\$23.95**

Round Plastic Dispenser Trays

Attached clear tops revolve to give access to the part you need. Ideal for watch parts, screws, findings and stones. Parts will not spill or mix. Available in two diameters. Large has removable top.

- 150.610** 7 3/4" 20 Compartment **\$8.50**
150.611 3 1/4" 12 Compartment **\$3.95**

39 Drawer Multi-Purpose Storage Cabinet

Heavy-duty plastic cabinet is perfect for organizing watch batteries, small parts, burs, drills, etc. Combination see-thru drawers for maximum versatility and easy identification of contents. Drawer stops prevent accidental spills. Cabinet measures 14 3/8" W x 17 7/8" H x 6 1/4" D. 30 Small removable drawers measure 2 1/8" W x 1 7/16" H x 5 1/4" D. Large drawers measure 4 3/8" W x 2 1/4" H x 5 1/4" D. Can be mounted on a wall.

- 810.224** **\$35.00**

This cabinet is included with our Energizer Master Battery Kit #810.220.

810.224



150.155

150.154

150.146



150.130-150.132



150.140



150.050



150.610

150.611

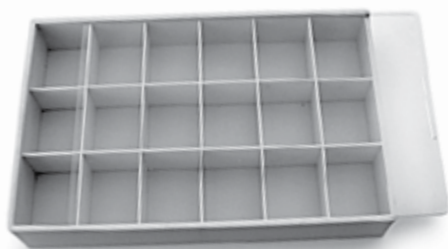

150.004

Sliding Lid Compartment Box

Perfect for anything you want to store. There is nothing like it in the industry

- Sliding lid opens and closes smoothly, and cannot flip open if dropped.
- Front edge of each compartment is rounded so beads, stones or findings can be retrieved easily.
- Overall size is 6³/₄" x 10¹/₂".
- 18 compartments, each measures 2" x 1⁵/₈" x 1¹/₂" deep.

150.004 **\$8.75**

150.055



Parts Storage Box has 18 compartments

Handy box measures 7⁵/₈" x 3³/₄" x 1³/₁₆", with 18 compartments measuring 1¹/₈" x 1" x ⁵/₁₆". Sturdy plastic with clear sliding lid.

150.055 **\$7.25**



640.6759.2

BERGEON Dust Cover protects parts on your bench

Clear plexiglass dust cover is very durable, transparent and nicely finished. 3¹/₂" x 8³/₄" x 1³/₄" (90 x 225 x 43mm).

640.6759.2 **\$103.95**



230.255

BERGEON Covered Parts Tray

Unbreakable, non-flammable plastic tray 4" diameter with dust cover for storing small parts. Clear plastic cover keeps parts safe and dust-free.

640.30097.BC Bergeon 30097-BC **\$25.95**

150.270 Economy Model **\$3.95**



640.30097.BC

Casing Cushion with Cover

This watch cushion has a clear acrylic protective dust cover. Base is 3⁵/₈" diameter, 2³/₈" high with cover. Swiss made.

230.255 **\$46.50**

BERGEON Casing Cushion

Non-slip, non-marring material on both sides of cushion protects watches when opening and closing cases, changing batteries, etc. Large 80mm diameter. Clean with soapy water. 9/16" high.

640.5393 **\$83.95**



640.5393

Watch Cushion

Handy cushion protects watch crystal and case when snapping on backs. Padded vinyl cushion in steel rim. 1/2" high.

640.5394 3" Bergeon **\$39.95**

590.680 3" diameter economy **\$23.50**

590.683 2" diameter economy **\$6.50**



590.680

Bergeon Case Cushion 5395

High quality gel forms to different case geometries to ensure watch cases remain stable and without scratches. Swiss made.

640.5395.55 55mm **\$39.95**

640.5395.75 75mm **\$42.95**



640.5395

Triangular Parts Tray

3" wide tray for holding a variety of small parts, stones, etc. Sturdy trays are self-nesting for easy storage. India.

150.153 Plastic **\$4.25 dz**

150.478 Aluminum **\$5.20 dz**



150.478



590.276

Movement Rests

11 plastic rings for round movements 7¹/₂ to 22¹/₂ ligne. India.

590.276 **\$4.95**

Stackable Watch Tray with 6 or 10 Compartments

Store and organize watch parts safely in this stackable plastic tray. Available with 6 or 10 compartments for small parts, findings, gems and more. The 6-compartment tray with pegs and holes has one long section for a watch with a bracelet or strap. Base is solid color with a see-thru lid and measures 9½" x 4¾" x 3/4". Trays stack neatly with each other.

150.272 6-Comp. Tray w/Lid **\$11.50 ea 5@\$9.95 10@\$9.25**

150.274 6-Compartment Tray only for Locking Lid **\$5.95**

150.273 10-Comp. Tray w/Locking Lid **\$11.50 ea 5@\$9.95 10@\$9.25**

Plain Lid will not fit on the 6-Compartment Tray with pegs.



150.272 6-Compartment Tray with Locking Lid

150.274 6-Compartment Tray only

Locking Lid and Stackable Tray

Six compartment tray with two holes and clear plastic lid with two holes that accept locking keys and fit both trays. Lid measures 9½" x 4¾" x 3/4".

150.271 **\$4.95**

Locking keys sold separately.



150.271 Locking Lid



One lid locks two trays using the 150.116 Key.



150.273 10-Compartment Tray with Lid
Available with Locking Lid or Plain Lid with no holes.

Keys for Locking Lid

Key only to lock clear plastic lid No.150.271 onto our trays No.150.272 & No.150.273. Two sizes; one for a single tray and one for locking two stacked trays and one lid. Price Each.

150.115 for One Tray **\$2.95**

150.116 for Two Trays **\$2.95**



150.115

150.116

Stackable Job Trays

Easy way to organize your work. Self-nesting for uniform stacking. Includes removable partition. 6" x 9" x 1½".

151.600* Yellow **\$2.95**

151.601 White **\$3.95**

151.602 Red **\$3.95**

151.603 Green **\$3.95**

151.604* Blue **\$2.95**

151.605* Ivory **\$2.95**

151.608 Black **\$3.95**

151.612* Brown **\$2.95**

151.613* Purple **\$2.95**

151.614* Burgundy **\$2.95**

151.609 Tray Tags/Pen (pk/100) **\$33.40**



151.600 - 151.614

*Special Order - Please allow 5-7 business days for delivery.



130.374

Cas-Ker Soft Work Pad

Cushioned mat keeps parts and tools on your bench and provides a soft surface for delicate parts. Light green color is easy on the eyes. Measures 13³/₄" x 9⁷/₈" x 1/16".

130.374

\$10.95



130.360

BERGEON Soft Work Pad with Adhesive Back

The adhesive backing keeps this pad in place on your benchtop. Light green rubber cushions parts and tools. Measures 13³/₄" x 9⁷/₈" x 1/16". Bergeon 2746.

130.360

\$53.95



130.371

Softy® Work Mat

Cushioned surface is Ideal for quartz watch repair and replacing cells. 11 x 14" white with non-slip backing. Anti-static, free from contamination. Protects delicate assemblies and depresses to give a sure grip on parts.

130.371

\$11.50

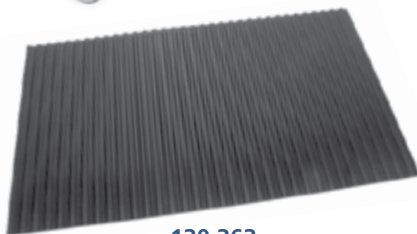

130.363

Rubber Bench Mats keeps small parts on your bench

Swiss made flexible rubber mats have ridges for keeping small parts from rolling around, and helps you separate and organize parts on your bench. Two sizes available.

130.363 Large 12" x 7"

\$27.95

130.364 Small 6¹/₄" x 4"

\$19.95



640.7808

BERGEON Anti-skid Bench Mat

Slightly soft and flexible this mat is ideal for assembly, casing and control in optimal conditions thanks to a better color contrast. The bottom is anti-skid so you don't have to stick the mat on your workbench and lets you choose a color adapted to your work. 320 x 240 x 2mm.

640.7808.1 Green

\$36.75

640.7808.2 Black

\$36.75

640.7808.3 White

\$36.75

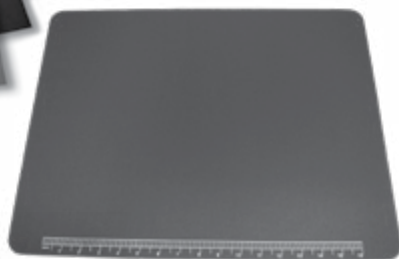

380.350

Blue Padded Work Mat

Padded work mat features a non-slip backing and 16" ruler markings on the bottom. Generous 20" x 15" work mat accommodates larger tools and accessories, while the bright blue backing makes it easy to keep small parts in sight. Perfect for jewelry makers, especially those working with wire.

380.350

\$8.95

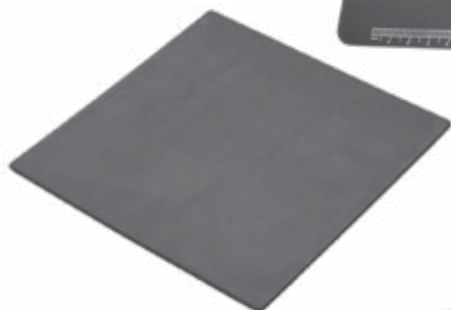

130.365

Heavy Duty Rubber Work Mat

Handy for hammering, filing and other uses. 1/4" thick non-slip surface is heat resistant and durable; prevents scratches on precious metals. Helps to deaden sound of hammering at the bench and its large 12" x 12" surface is great for various size projects.

130.365

\$19.95



131.0183

White Enamelled Bench Plate

Baked white enamel finish on masonite won't chip or peel. Edge is grooved so small parts will not roll off. Ideal for watch and jewelry repair. 16" x 9".

131.0183

\$14.20

Repair Tags

A staple item of any jewelry business. All of these tags are durable and will take writing, without smearing or smudging. Strung with quality cord. Imprinting is available on some tags.

Printed Tags with Claim Checks

Tags feature tear-off claim checks Both parts are numbered clearly. White Tags measure 2⁷/₈" x 2³/₈" Sold in boxes of 1000.

Number	Claim Numbers	Number	Claim Numbers	Per 1000
611.251	0001 to 1000	611.256	5001 to 6000	\$59.70
611.252	1001 to 2000	611.257	6001 to 7000	\$59.70
611.253	2001 to 3000	611.258	7001 to 8000	\$59.70
611.254	3001 to 4000	611.259	8001 to 9000	\$59.70
611.255	4001 to 5000	611.260	9001 to 10000	\$59.70



**611.251 -
611.260**

Printed Tags

Available in white only, no imprinting available. 2³/₄" x 1". Sold in boxes of 1000.

611.300 **\$38.75/1000**



611.300

Plain White Tags

Available with round corners, no imprinting available. 2³/₄" x 7/8". Sold in boxes of 1000.

611.193 **\$52.00/1000**



611.193

Watch and Jewelry Repair Record Book

Room for 2000 entries. Wide spaces to record all information of a repair: name, address, record number, dates, complete description of article, repairs and charges. Each line is a complete transaction. Records should be kept for three years. Hard cover, 142 pages.

621.01135 **\$25.15**



621.01135

Also see page 231 for sorting pads, appraisal forms, & more.

Watchmaker's Bench Tray

This tray keeps your small tools and parts organized and safe on your watchmaker's bench. Various sized compartments accommodate a number of items. Blue color makes it easy to see small parts. Soft plastic feet keep the tray from sliding around. 10⁷/₈" x 9³/₈" x 1/2". Swiss made.

150.001 **\$56.00**



150.001

Slim Watchmaker's Tray fits most benches

This smaller tray keeps your tools and parts safe in your watchmaker's bench. Six various sized compartments accommodate a number of items. Blue color is easy on the eyes and makes it easy to see small tools. Non-slip feet keep the tray from sliding around. 10³/₈" x 6³/₈" x 9/16". Swiss made.

150.008 **\$41.95**



150.008



Poly Zip Bags

Thousands of uses; customer orders, stones, parts, findings, displays, etc. 2 or 4 mil thick bags provide tight seal. Available completely clear or with white label block which will accept ball point pen or marker for identification.

Plain Poly Zip Bags - 2 mil thick

Size	Number for 100 Bags	Per 100	Number for 1000 Bags	Per 1000
1 x 1"			610.119.02	\$6.50
2 x 2"	610.120.01	\$1.40	610.120.02	\$8.40
2 x 3"	610.121.01	\$1.70	610.121.02	\$10.20
3 x 4"	610.122.01	\$2.15	610.122.02	\$12.90
3 x 5"	610.123.01	\$2.65	610.123.02	\$15.90
4 x 6"	610.125.01	\$3.75	610.125.02	\$22.50

Super Zip Bags - 4 mil thick

2 x 3"	610.135.01	\$2.10	610.135.02	\$14.70
3 x 4"	610.136.01	\$2.65	610.136.02	\$18.55
3 x 5"	610.137.01	\$2.80	610.137.02	\$19.60
9 x 12"	610.140.01	\$15.00	610.140.02	\$103.25
13 x 18"	610.141.01	\$24.95	610.141.02	\$174.65

Zip Bags w/White Block - 2 mil thick

2 x 2"	610.130.01	\$1.35	610.130.02	\$9.45
2 x 3"	610.131.01	\$1.90	610.131.02	\$13.30
3 x 4"	610.132.01	\$2.50	610.132.02	\$17.50
3 x 5"	610.133.01	\$4.00	610.133.02	\$28.00



640.7982



640.715

Protective Film

Anti-static transparent PVC film for packaging watches, jewelry and other luxury items. Effectively protects valuable items from scratches, fingerprints, dust, etc. Guarantees new or repaired items will remain clean. Handy roll lets you cut the length you need. 50mm (2") Wide x 50 meters (54 yards) long.

640.715 **\$23.50**

High quality, economical clear static vinyl wraps protect both finish and crystal from scratching during handling and shipping. Available Round and three Rectangle sizes.

630.300 Round 1 1/4"	\$99.00/1000
630.301 Rectangle 2" x 3"	\$68.00/500
630.302 Rectangle 2" x 5"	\$39.75/250
630.303 Rectangle 1 1/2" x 3"	\$59.95/500
630.304 Rectangle 3" x 5"	\$46.50/250

Round vinyl sheets protect watch components when working with hands, bezels or case backs. Strong and flexible. 5 sheets per pack. Bergeon.

640.7982.60 60mm diameter	\$14.95
640.7982.85 85mm diameter	\$14.95



630.300 -
630.304

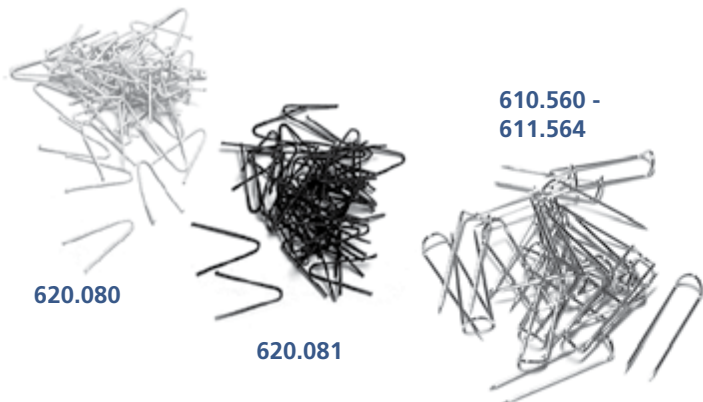

620.080

620.081

610.560 -
611.564

Twisty Wires

Paper covered wires hold jewelry on pads. 1 1/2" long. Priced 200 or 1000 of a color.

620.080 White	\$3.50/200	\$11.00/1000
620.081 Black	\$3.50/200	\$11.00/1000

Jewelry Pins

Pins have long sharp points for pinning all types of jewelry to pads, trays, easels, etc. Boxes of 1000 or 100.

610.560 White 1000	\$11.95
610.563 Yellow 1000	\$11.95
611.561 White 100	\$6.30
611.564 Yellow 100	\$6.30

Envelopes to Keep All Your Repair Jobs in Order

Triple Duty Repair Envelopes

Each numbered envelope has two numbered detachable stubs; one for the customer and the other for filing. Standard kraft paper. Envelope measures 5³/₄" x 3¹/₈" and is packed 1,000 to a box. Box weight 8 lbs.

Number	Series	Price per 1000
611.15101	0001 to 1000	\$47.50
611.15201	1001 to 2000	\$47.50
611.15301	2001 to 3000	\$47.50
611.15401	3001 to 4000	\$47.50
611.15501	4001 to 5000	\$47.50
611.15601	5001 to 6000	\$47.50
611.15701	6001 to 7000	\$47.50
611.15801	7001 to 8000	\$47.50
611.15901	8001 to 9000	\$47.50
611.16001	9001 to 10000	\$47.50

Blank Job & Coin Envelopes

Very handy and can be rubber stamped with your name and address. Identifies your work when you send samples or orders to your supplier and helps prevent misdirected orders. With gummed flaps.

No.	Size - Inch	Description	Box	Price
611.112	2 ³ / ₄ x 1 ³ / ₄	#00 White	1000	\$79.95
611.113*	4 ¹ / ₄ x 2 ¹ / ₂	#3 Kraft	500	\$25.80
611.0131	4 ¹ / ₂ x 3	#4 Kraft	500	\$27.35
610.114	5 ¹ / ₂ x 3 ³ / ₈	#5 Kraft	500	\$16.30
610.115	5 ¹ / ₂ x 3 ³ / ₈	#5 White	500	\$18.95
611.110*	1 ¹ / ₂ x 1	White Woven	1000	\$164.50
611.111*	1 ¹ / ₂ x 1	White Waxed	1000	\$129.50

Jewelry/Watch Repair Envelope

Works for both jewelry and watch repair. Back side lists birthstones and appropriate gifts for each wedding anniversary. There is a box at the bottom of the envelope for your name. Teal on white. 500 per box.

610.173 \$26.25 /500

Box for Repair Envelopes

Classic black box holds hundreds of job envelopes, coin size or numbered triple-duty type. Covered in heavy textured vinyl and measures 14³/₄" x 4" x 4". Envelopes not included.

610.165 \$11.50

Acrylic Envelope Box keeps your repair jobs organized

Toss out that cardboard box and get your repair jobs in order. Four section box measures 10³/₄" x 3¹/₂" x 3¹/₂". Makes a good impression when brought to your customer counter. Envelopes not included.

610.168 \$14.25



610.114
610.115

611.15101 -
611.16001



610.173



610.165



610.168



630.178

630.185

630.172

White String Tags

Strong white paperboard with red string. Shown actual size. 1000 per box. Made in U.S.A.

630.172, 630.178, 630.185 **\$23.25/1000**



601.060

601.065

601.075

Economy White String Tags

White paper with red strings. Tags shown are actual size. Made in India. Sold in boxes of 1000.

601.060	5/8" x 1/4"	Writing Area	\$8.50/1000
601.065	1/2" x 5/16"	Writing Area	\$8.95/1000
601.075	5/8" x 3/8"	Writing Area	\$8.95/1000



630.907

630.917GW

Gold Plastic String Tags

Versatile Arch Crown gold plastic tags are easy to use. Keep merchandise clean from messy glue residue. Ultrasonic-proof when used with a permanent marker. 5/8" x 3/8". Boxes of 1000

630.907 **\$65.95/1000**

Gold Tag Stock String Tags

Arch Crown parchment/paper tags are gold on one side with matching gold strings. 7/8" x 7/16". Boxes of 1000

630.917GW **\$54.45/1000**

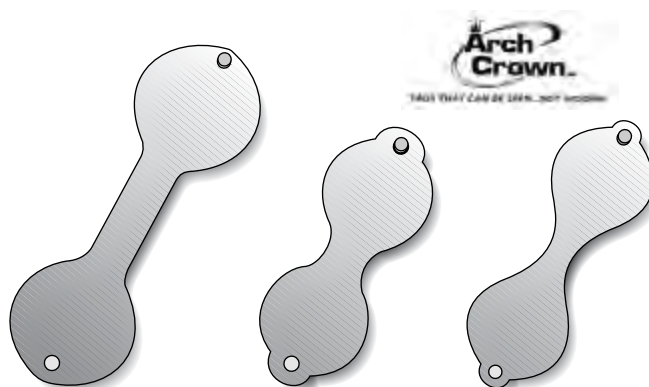

630.721

630.702

630.720

Arch Crown Tags

Easy to use plastic button-fast tags enhance your jewelry value. Close by hand or with pen barrel. Arch Crown tags are unsurpassed for cut and clarity.

- Gold and Silver tags can be used with Permascribe or Permanent Ink.
- New Gold and New Silver "uncoated" tags are smudge proof with no coating to rub off, and can be used in ultrasonic cleaning solutions. No more scribing, just use a permanent marking pen.

Tag Number	Color	per 1000
630.721W	White	\$64.95
630.721F	Frosted	\$62.75
630.721CS	Silver	\$62.75
630.721CG	Gold	\$62.75
630.721NG	New Gold Uncoated	\$69.95
630.721NS	New Silver Uncoated	\$62.75
630.702W	White	\$64.75
630.702F	Frosted	\$64.75
630.702NS	New Silver Uncoated	\$65.00
630.702CG	Gold	\$61.95
630.702NG	New Gold Uncoated	\$61.95
630.720W	White	\$64.95
630.910	Eyelets for Arch Crown Tags	\$19.75



630.710B Black Permanent Fine Marking Pen for all tags **\$6.50**

630.710R Red Permanent Fine Marking Pen for all tags **\$6.50**

630.711 Permascribe Stylus etcher for gold & silver tags **\$10.95**

Shark-Skin™ Jewelry Repair and Identification Tags

- Self-stick, needs no moistening. Adhesive free center bar.
- Retains shape and color in ultrasonics, ionic cleaners or under steam pressure.
- Rings can be tried on without removing tag.
- Free marking pen included.



Package of 1,000		
No.	Color	Price
601.701	White	\$8.15
601.702	Blue	\$8.15
601.703	Yellow	\$8.15
601.704	Silver	\$8.15
601.708	Gold	\$8.15

Package of 1,000		
No.	Color	Price
601.710	White	\$9.80
601.712	Yellow	\$13.10

Package of 500		
No.	Color	Price
601.705	White	\$5.95
601.706	Blue	\$5.20
601.707	Yellow	\$7.50

Packages of 500		
No.	Color	Price
601.715	White	\$8.15
601.716	Blue	\$8.15
601.717	Yellow	\$8.75

Packages of 500		
No.	Color	Price
601.720	White	\$8.90
601.722	Yellow	\$10.35

Shark Skin Pen

(included with each set).

601.700 \$2.75



Tags for Computer Printing



610.720
-611.765

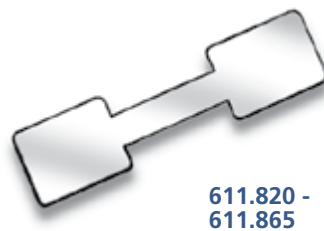

611.820 -
611.865

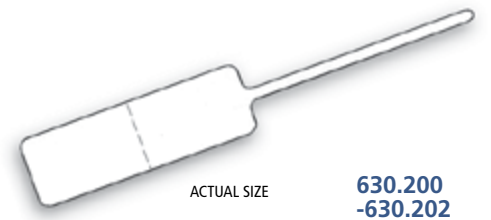

ACTUAL SIZE
630.200
-630.202

SHARK-SKIN™ Tags for Dot Matrix Printers

Primarily used for dot matrix printers; however, suitable for typewriters or hand marking. Mounted three across on flat, pin-feed, fan-folded sheets. Waterproof and safe for ultrasonics, with adhesive-free center section. Free marking pen No.601.700 in each package.

Color	Pk/1,000	Price	Pk/10,000	Price
White	610.720	\$14.50	611.725*	\$119.00
Blue	611.730*	\$20.50	611.735*	\$129.95
Gold	611.750	\$18.75	611.755*	\$119.00
Silver	611.760*	\$19.50	611.765*	\$129.00
601.700	Shark Skin Marking Pen			\$2.75

Mylar Tags for Dot Matrix Printers

Stronger and smoother for a cleaner print. Mounted three across on flat, pin-feed, fan-folded sheets. Waterproof and safe for ultrasonics. Free marking pen No.601.718 in each package.

Color	Pk/1,000	Price	Pk/10,000	Price
White	611.820	\$29.25	611.825*	\$189.95
Blue	611.830*	\$26.95	611.835*	\$177.50
Yellow	611.840*	\$26.95	611.845*	\$177.50
Gold	611.850*	\$32.95	611.855*	\$195.00
Silver	611.860*	\$32.95	611.865*	\$189.95
601.718*	Special marking pen			\$2.75

Computer String Tags

Labels for dot matrix pin-feed printers are ideal for rings, chains and all types of jewelry. Simply thread through item and stick ends together. Loops are adjustable and have no adhesive to touch jewelry. Made of tough Tyvek®, labels are 2 across on flat, fan-folded sheets.

Number	Price per 1000 tags
630.200	Gold \$25.95
630.201	Silver \$25.95
630.202	White \$25.95

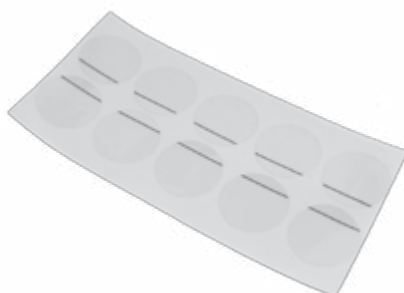

Self-Stick Labels with Red Line for Watch Case Backs

630.021	10mm	\$2.95/100	630.028	24mm	\$4.25/100
630.022	12mm	\$2.95/100	630.029	26mm	\$4.25/100
630.023	14mm	\$2.95/100	630.030	28mm	\$4.25/100
630.024	16mm	\$2.95/100	630.031	30mm	\$5.50/100
630.025	18mm	\$2.95/100	630.032	32mm	\$5.50/100
630.026	20mm	\$3.50/100	630.033	34mm	\$5.50/100
630.027	22mm	\$3.50/100			

BAGS, BOWS & TISSUE

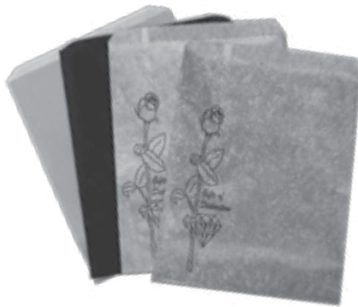

Paper Bags

Size	Pink	Per 1000	Black	Per 1000	Silver	Per 1000	Gold	Per 1000
4 x 6	-	-	-	-	611.173	\$89.00	611.174	\$81.15
5 x 7	-	-	-	-	611.177	\$84.70	611.178	\$66.10
6 x 9	610.160	\$7.50	610.190	\$7.50	611.179.1	\$7.25	611.180.1	\$7.25
8 x 11½	610.161	\$9.95	610.191	\$9.95	611.181.1	\$10.95	611.182.1	\$11.25
12 x 15	610.162	\$15.95	610.192	\$19.50	-	-	-	-

Drawstring Pouches

Genuine suedine pouches are ideal for charms, necklaces, etc. Packed by 10.

Royal Gray		Per 10	Per 100
670.900.2	2¾" x 3¾"	\$4.25	\$38.25
670.901.2	3¼" x 4½"	\$5.50	\$49.95

Black		Per 10	Per 100
670.900.1	2¾" x 3¾"	\$4.25	\$38.25
670.901.1	3¼" x 4½"	\$5.50	\$49.50
670.902.1	4¼" x 5¾"	\$5.95	\$53.50

Red		Per 10	Per 100
670.901.3	3¼" x 4½"	\$5.50	\$49.95



Mini Foil Gift Bags

Metallic foil gift bags in assorted colors have matching gift cards. 3" x 2½"

610.810 **\$31.50/100**



820.001 - 820.024



820.025



610.230- 610.235

Gift Bows

2" Bows have 16 loops of 3/8" ribbon. 300 per pack.

820.020 Silver	\$34.50
820.001 White	\$34.50
820.013 Red	\$34.50
820.024 Assortment	\$48.95

Fuchsia Bow

Stick-on Star Bow, 2¾" diameter. Box / 200.

820.002 **\$20.95**

Iridescent White Bows

Stick-on bows go with any paper for any occasion. 1¼" diameter. Box of 100.

820.025 **\$27.25**



Curling Ribbon

Red, Green or White ribbon is perfect for jewelry gifts. 3/16" wide x 500 yards.

610.240 Red	\$4.95
610.241 Green	\$4.95
610.242 White	\$4.95

Berwick

Splendorette® Ribbon

Polypropylene Flat Ribbon measures 3/4" wide. Price per spool.

610.220 White	250yds	\$10.50
610.221 Red	250yds	\$10.50
610.222 Silver	250yds	\$10.50
610.223 Pink	250yds	\$10.50
610.224 Green	250yds	\$10.50

Berwick Bow Magic™ Pull Bows

Perfect for jewelry boxes and simple to use. 1¾" diameter with 18" of banding ribbon. Priced per box of 100 bows, one color.

610.230 White	\$24.95
610.234 Gold Metallic	\$32.50
610.235 Silver Metallic	\$36.75



610.092



611.051

Tissue Cutter

Spring cutting bar mounted on wood base. For 7¾" wide jeweler's tissue and gift wrap.

610.092 **\$11.25**

Anti-Tarnish Tissue

For wrapping silverware, jewelry and other gifts. Made of the finest quality white bleached tissue, which will not tarnish the merchandise. Comes in rolls or flat reams.

Silver	Description	Shipping Weight	Price
611.051	7¾" roll	3 lbs	\$18.90
611.052	20" roll	7 lbs	\$39.95
611.053	20" x 30" ream	8 lbs	\$40.75

The Perfect Gift Wrap for Every Occasion

Ideal gift wrap for jewelry and related items. Rolls are 7³/₈" wide x 150' long (except 610.3022). Patterns shown actual size. Prices per roll.



White on White Stripe
610.2020 **\$21.95**



Silver Foil w/White Stripe
611.075 **\$23.10**



White Polka Dots on Pearl background
610.3106 **\$21.95**

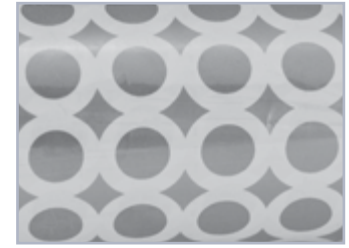

Gold and Silver Dots
610.6348 **\$21.95**

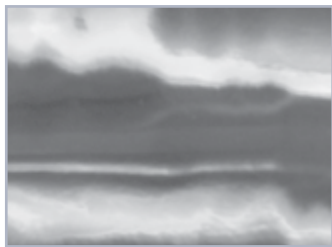

Rainbow Hologram Silver Foil
611.097 **\$23.10**

Note: Tends to curl and has a pronounced line every 20" - an unavoidable part of the manufacturing process.

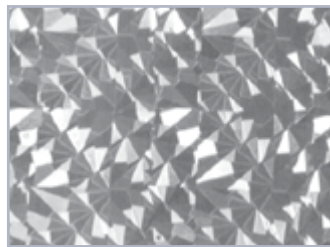

Cracked Ice Hologram Silver Foil
611.095 **\$23.10**



City Lights Hologram Silver Foil.
611.096 **\$23.10**

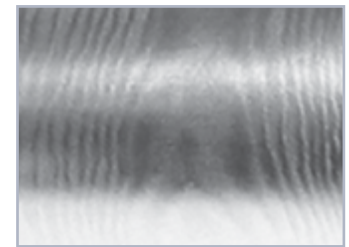

610.9010 Silver Foil **\$27.50**
610.9106 Gold **\$39.95**
610.9107 Red Foil **\$38.50**
610.9108 Green **\$21.00**



Gold snowflakes on blue
610.4169 **\$18.95**

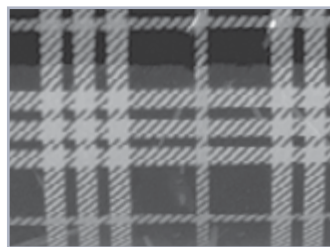

Green and Red plaid
610.5710 **\$21.95**



Silver Metallic Holly and Red Berries on White
610.4508 **\$36.50**

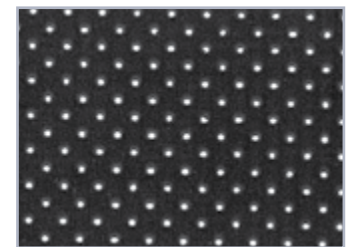

Red with White Dots
610.3896 **\$20.95**

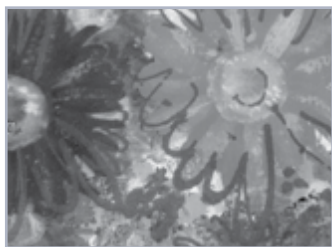

Gilded Daisies, jewel tone with gold accents
610.6037 **\$19.95**

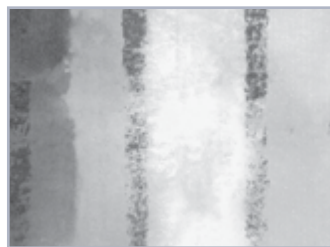

Rainbow Water Color Stripe with gold accents
610.7095 **\$20.95**



Purple Foil with Red & Silver Stars
610.098 **\$9.50**

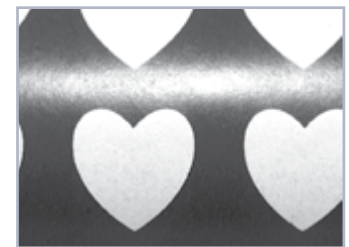

Valentine Hearts, Red and White
610.1260 **\$17.50**

See our gift wrap in color at casker.com

Cotton Filled Cardboard Boxes in Sizes for a Variety of Gifts



Tropical Print Boxes

100 cotton filled boxes, tropical floral print lid and base. Filled with non-tarnishing jeweler's fiber.

670.000.F	2 ⁷ / ₈ " x 1 ⁵ / ₈ " x 1 ³ / ₁₆ "	\$36.95
670.001.F	3" x 2 ¹ / ₈ " x 1"	\$39.95
670.002.F	3 ¹ / ₂ " x 3 ¹ / ₂ " x 7 ⁸ / ₈ "	\$52.00
670.003.F	5 ⁷ / ₁₆ " x 3 ¹ / ₂ " x 1"	\$63.00
670.004.F	3" x 2 ¹ / ₈ " x 1"	\$59.95
670.004.F	8" x 2" x 7 ⁸ / ₈ "	\$59.95
670.007.F	7" x 5" x 1 ¹ / ₄ "	\$79.95

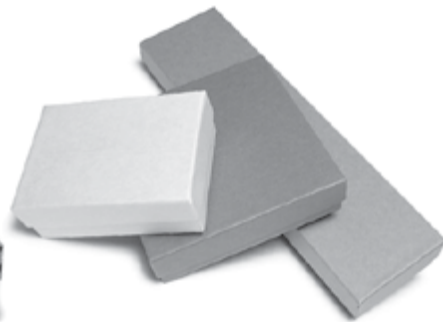

Kraft Covered in Colors

Individual sizes priced per 100. Minimum order 100 of a number.

Pink		Per 100
670.001.9	3 x 2 ¹ / ₈ x 1"	\$33.50
670.002.9	3 ¹ / ₂ x 3 ¹ / ₂ x 7 ⁸ / ₈ "	\$36.95
670.004.9	8 x 2 x 7 ⁸ / ₈ "	\$42.95
Purple		Per 100
670.000.12	2 ¹ / ₂ x 1 ¹ / ₂ x 7 ⁸ / ₈ "	\$27.75
670.001.12	3 x 2 ¹ / ₈ x 1"	\$33.50
670.002.12	3 ¹ / ₂ x 3 ¹ / ₂ x 7 ⁸ / ₈ "	\$36.95
670.004.12	8 x 2 x 7 ⁸ / ₈ "	\$42.95
Green		Per 100
670.001.11	3 x 2 ¹ / ₈ x 1"	\$33.50
670.002.11	3 ¹ / ₂ x 3 ¹ / ₂ x 7 ⁸ / ₈ "	\$36.95
670.004.11	8 x 2 x 7 ⁸ / ₈ "	\$42.95
Light Green		Per 100
670.001.10	3 x 2 ¹ / ₈ x 1"	\$33.50
670.002.10	3 ¹ / ₂ x 3 ¹ / ₂ x 7 ⁸ / ₈ "	\$36.95
Light Blue		Per 100
670.001.13	3 x 2 ¹ / ₈ x 1"	\$33.50
670.002.13	3 ¹ / ₂ x 3 ¹ / ₂ x 7 ⁸ / ₈ "	\$36.95
670.004.13	8 x 2 x 7 ⁸ / ₈ "	\$42.95

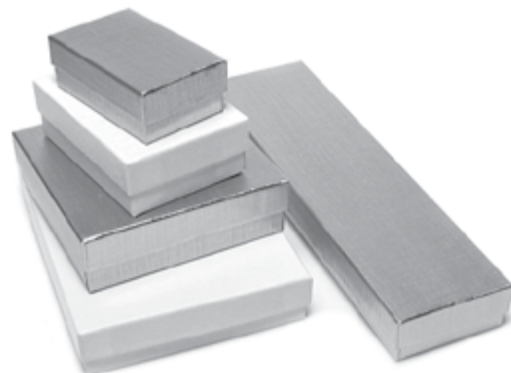

White Swirl and Gold Foil

Jeweler's assortments of 78 white or gold cardboard boxes include 6 different sizes.

670.005.4	White Asst	\$33.95
670.005.5	Gold Asst	\$41.95

Individual sizes priced per 100. Minimum order 100 of a number.

White Swirl		Per 100
670.010.1	2 x 1 ¹ / ₂ x 5 ⁸ / ₈ "	\$31.95
670.000.4	2 ¹ / ₂ x 1 ¹ / ₂ x 7 ⁸ / ₈ "	\$27.95
670.001.4	3 ¹ / ₁₆ x 2 ¹ / ₈ x 1"	\$31.50
670.002.4	3 ¹ / ₂ x 3 ¹ / ₂ x 1"	\$37.75
670.009.1	3 ¹ / ₂ x 3 ¹ / ₂ x 1 ⁷ / ₈ "	\$43.50
670.003.4	5 ¹ / ₄ x 3 ³ / ₄ x 7 ⁸ / ₈ "	\$44.50
670.007.4	7 x 5 x 7 ⁸ / ₈ "	\$59.95
670.004.4	8 x 2 x 7 ⁸ / ₈ "	\$40.95
Gold Foil		Per 100
670.000.5	2 ¹ / ₂ x 1 ¹ / ₂ x 7 ⁸ / ₈ "	\$31.50
670.001.5	3 ¹ / ₁₆ x 2 ¹ / ₈ x 1"	\$32.50
670.002.5	3 ¹ / ₂ x 3 ¹ / ₂ x 1"	\$41.95
670.003.5	5 ¹ / ₄ x 3 ³ / ₄ x 7 ⁸ / ₈ "	\$47.75
670.004.5	8 x 2 x 7 ⁸ / ₈ "	\$45.75



670.006.5

Foil Ring Boxes

Cardboard boxes covered with gold foil have a black flock pad. 1³/₄" x 1⁵/₈"H.

Per 100

670.006.5	\$41.00
------------------	----------------

Silver Hammer-Texture Wrapped Paper Boxes

Black ribbon
Black inserts
Hinged lids

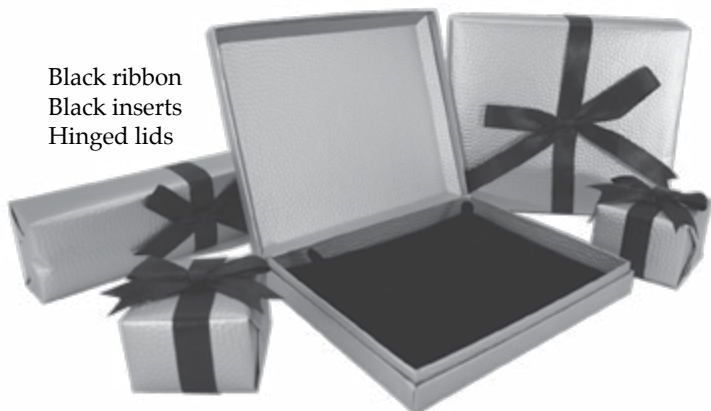

670.830	Ring 2-1/8" x 2-1/8" x 1-1/2"	\$1.95 each Buy 12 or more at just \$1.75 each!
670.831	Watch 4" x 4" x 3"	\$4.50 each Buy 12 or more at just \$4.00 each!
670.832	Earring 2-1/8" x 2-1/8" x 1-1/2"	\$1.95 each Buy 12 or more at just \$1.75 each!
670.833	Bracelet 8" x 1-3/4" x 1-1/4"	\$3.50 each Buy 12 or more at just \$3.00 each!
670.834	Pendant 3-3/8" x 3-3/8" x 1-1/4"	\$2.50 each Buy 12 or more at just \$2.20 each!
670.835	Necklace 6-1/8" x 5-1/8" x 1-1/4"	\$5.25 each Buy 12 or more at just \$4.75 each!

Sophisticated leatherette packaging for the finest gifts.



Leatherette Bracelet
 2¹/₈ x 8⁵/₈ x 1"
 670.803.1 Black
 670.803.3 Red
\$40.95 dz



Leatherette Ring Box
 2 x 1³/₄ x 1¹/₂"
 670.800.1 Black
 670.800.3 Red
\$18.95 dz



Leatherette Earring Box
 2¹/₂ x 2³/₈ x 1"
 670.802.1 Black
 670.802.3 Red
\$24.95 dz



Leatherette Pendant Box
 2⁷/₈ x 4 x 1¹/₈"
 670.801.1 Black
 670.801.3 Red
\$34.95 dz

Red or black leatherette boxes have gold trim, satin lining, and come in their own packers.

Delight your customers at every moment of jewelry buying! Wrap up each sale with elegant and affordable packaging from Cas-Ker.

JEWELRY BOXES | BAGS | POUCHES | RIBBONS & BOWS | GIFT WRAP | TISSUE

10% discount on six dozen or more assorted boxes.

Classy Leatherette Boxes

A great value in elegant packaging. White-on-white boxes look and feel like soft leather. All come in their own packers.



Leatherette Pendant Box
 670.542.4 **\$29.95 dz**



Leatherette Ring Box
 670.540.4 **\$20.95 dz**



Leatherette Earring Box
 670.541.4 **\$24.95 dz**

Leatherette Bracelet or Watch Box
 670.543.4 **\$37.50 dz**



Versatile & Economical Nylon Flock

All have matching inserts and their own packers



Pendant Box

2³/₈ x 3 x 1¹/₄".

- 670.304.1 Black
- 670.304.2 Gray
- 670.304.3 Red
- 670.304.16 Plum

\$16.75 dz



Pearl/Necklace Box

6³/₄ x 4¹/₄ x 1³/₄".

- 670.305.1 Black

\$41.95 dz



Bracelet/Watch

3¹/₂ x 3¹/₂ x 2"

- 670.306.1 Black

\$2.10 dz

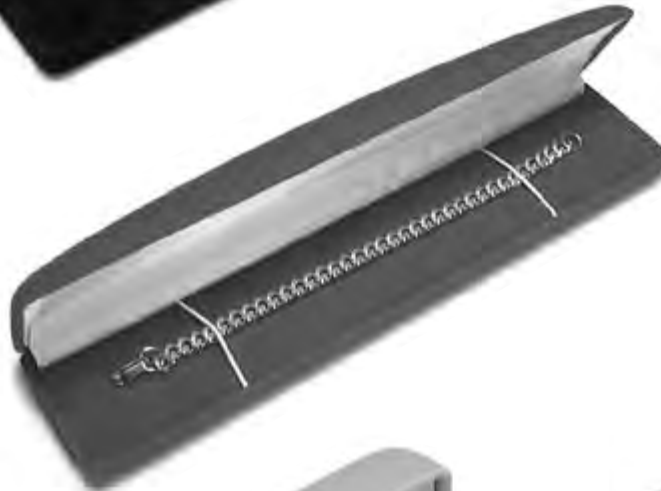

Bracelet/Watch Box

9³/₈ x 2¹/₄ x 1¹/₄".

- 670.307.1 Black
- 670.307.2 Gray
- 670.307.3 Red

\$21.00 dz



Earring or Pendant

2 x 2¹/₄ x 1¹/₄".

- 670.303.1 Black
- 670.303.2 Gray
- 670.303.3 Red
- 670.303.16 Plum

\$14.75 dz



Ring Box

1³/₄ x 1⁷/₈ x 1¹/₂".

- 670.300.1 Black
- 670.300.2 Gray
- 670.300.3 Red
- 670.300.16 Plum

\$13.50 dz



Large or Double Ring Box

2 x 2¹/₄ x 1³/₈".

- 670.301.1 Black
- 670.301.2 Gray
- 670.301.3 Red

\$15.25 dz

Round Ring

2¹/₈ x 2 x 1¹/₂".

- 670.302.1 Black
- 670.302.2 Gray
- 670.302.16 Plum

\$14.75 dz



10% discount
on six dozen or more assorted boxes

Classic Velvet Packaging

Metal shell boxes are covered in velvet and lined with petal velvet and satin puffs. Available in Black or Red. All have white outside packers.



Velvet Earring Box
2 3/8 x 2 x 1 3/8"
670.402.1 Black
670.402.3 Red
\$19.95 dz



Velvet Ring Box
1 3/4 x 1 7/8 x 1 1/2"
670.400.1 Black
670.400.3 Red
\$19.95 dz



Velvet Double Ring
2 3/8 x 2 x 1 3/8"
670.401.1 Black
670.401.3 Red
\$22.95 dz



Velvet Pendant Box
2 3/4 x 3 1/2 x 1 1/4"
670.403.1 Black
670.403.3 Red
\$25.95 dz



Velvet T-Shape Earring Box
2 1/4 x 3 x 1 1/4"
670.405.1 Black
670.405.3 Red
\$25.95 dz

10% discount
on six dozen or more
assorted boxes



Velvet Bracelet Box
8 x 2 x 1 1/8"
670.404.1 Black
670.404.3 Red
\$40.95 dz

Earring Pads & Tabs



Puff Pads in Gray, White and Black

Puff Pads, no imprint or holes, measure 1 3/4" x 1 1/2".

- 610.601** Gray Pad
- 610.607** White Pad
- 610.606** Black Pad
- \$3.95 dz 6dz@\$3.50dz 12dz@\$3.25dz**

Puff Pad. Earring center punches. No imprint.

- 610.600** Gray Earring Pad
- 610.605** White Earring Pad
- 610.602** Black Earring Pad
- \$3.95 dz 6dz@\$3.50dz 12dz@\$3.25dz**

Puff Pad. Earring center punches. "14KT. GOLD" imprint.

- 610.603** Gray 14K Earring Pad
- 610.609** White 14K Earring Pad
- 610.608** Black 14K Earring Pad
- \$3.95 dz 6dz@\$3.50dz 12dz@\$3.25dz**

Earring Hang Tabs

Clear plastic tabs allow you to hang almost any item as if it were an earring. Simply reveal the adhesive strip, attach to back of puff pad and hang on display. 1" x 1 1/2".

610.611

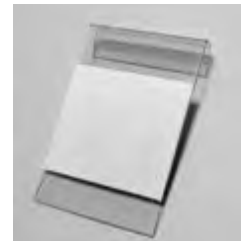

\$5.25/100

Sparkling Crystal Clear Boxes

Clear Boxes have Black Velvet Pads and Outer Boxes.



Ring Box
17/8 x 17/8 x 17/8"
670.201 **\$11.95 dz**



Ring Box
11/4 x 11/4 x 13/4"
670.200 **\$8.75 dz**



Single or Double Ring Box
23/8 x 15/8 x 13/4"
670.202 **\$12.75 dz**



Earring/Tie Tac Box
17/8 x 17/8 x 2"
670.203 **\$6.50 dz**



Necklace or Pearl Box
61/4 x 31/4 x 11/2"
670.206 **\$22.95 dz**



Bracelet or Watch Box
9 x 2 x 11/8"
670.208 **\$19.50 dz**



Pendant Box
23/4 x 31/2 x 11/8"
670.205 **\$14.25 dz**

Charming Petite Hat Boxes



670.506

Round Petite Hat Boxes

Paper covered ring boxes in assorted colors with ribbons. All Round 17/8" x 13/8".
670.506 **\$5.25 dz** **4 dz @ \$4.75 dz**



670.606

Assorted Petite Boxes

Colorful paper ring boxes have matching bows. Assorted Shapes, 13/4" x 11/2".
670.606 **\$5.75 dz** **4 dz @ \$5.25 dz**



670.706

Petite Ring Hat Boxes Assorted

Brightly colored plastic ring boxes with bows and foam ring inserts. Assorted shapes, 17/8" x 13/8". Price per dozen. Case of 4 dozen \$16.80.
670.706 **\$4.95 dz** **4 dz @ \$4.50 dz**

Novelty & Seasonal Favorites



Ball Ornament Boxes

Silver Ring ball ornaments are perfect for holiday gifts. 2 1/4" diameter.

670.102.8 \$19.50 dz



Drum Ornament Ring Box

Gold Drum Ring Box measures 1 3/4" x 2".

670.504.5 \$10.95 dz



Bell Ornament Earring Box

3 1/8" tall with a 2 1/4" diameter.

670.100.5 Gold \$10.95 dz
670.100.8 Silver \$9.95 dz



Crystal Clear Ornament Ring Box

Black velvet pad. Outer box included. 2 1/4" diameter.

670.210 \$7.95 dz



Red Heart Ring Box

Red nylon flock gift box has matching insert and measures 2" x 1 3/4".

670.502.3 \$11.75 dz



Red Boot Ring Box

Red and white flocked boot has a gold string to hang on the tree. 1 3/4 x 2 1/2".

670.104.3 \$14.95 dz



Praying Angel Ring Box

White flocked angel ring box also makes a great display. 3 1/4" tall.

670.600 \$8.95 dz



Rosebud Ring Boxes in Red or Pink

This charming ring box is available with or without a stem. Bud is flock with white inside and green leaves. Measures 1 3/4" in diameter, 10 1/2" long overall with stem.

670.507.3 Red/With Stem \$2.50 dz
670.508.3 Red/No Stem \$13.50 dz
670.507.9 Pink/With Stem \$2.50 dz
670.508.9 Pink/No Stem \$13.50 dz

Create a stunning new jewelry display instantly with an elegant showcase set.



White faux leather displays trimmed in solid wood with a deep glossy finish.

610.570

White Leatherette and Rosewood Showcase Set

A tray or stand for every type of jewelry in this luxurious 25 piece jewelry display. White faux leather with rosewood finish trim. Four Ring Stands, Ring Tray, Ring Stick, Ring Ramp, Pendant Tray, two Pendant Stands, T-Bar, Bracelet Tray, Bust Stand, Neckform, Earring Tray and Stand, two Earring Trees, 5-piece Base and 2-piece Platform. Overall: 40"W X 18"D X 16"H.

610.570

\$279.00



610.587



610.475



610.588



610.014



610.566



610.474



610.476

White Leatherette and Rosewood Necklace Bust

Show off your pendants and chains on soft white faux leather and glossy rosewood. Bust measures 5½"H x 6¾"W x 4¾"D.

610.587

\$12.50

White Leatherette and Rosewood Necklace Bust

10"H x 7½"W x 4"D large bust.

610.475

\$21.95

White Leatherette and Rosewood Pendant Display

Displays 3 to 5 pendants. 8½"L x 4½"W x 1¾"H. Top section lifts off to contain neckchains.

610.566

\$16.95

White Leatherette and Rosewood Earring Tree

2½" x 3" x 4½" drop style holds one pair of earrings.

610.588

\$8.50

White Leatherette and Rosewood Earring Tree

4¼" tall whale tail earring tree holds two pairs of earrings.

610.014

\$6.50

White Leatherette and Rosewood Bracelet Display

8"L x 1⅞"W x 1¾"H. A wire on the end of the stand holds bracelet.

610.476

\$9.50

White Leatherette and Rosewood Ring Display

Displays 5 rings. 8½"L x 4½"W x 1¾"H. Top section lifts off.

610.574

\$15.95

Enhance your jewelry with classic Black Velvet.



Necklace Cone
610.004 \$9.50



Necklace Easel
610.010 \$26.95



Bracelet Ramp
610.006 \$17.75



Pendant Display
610.003 \$8.50



Earring/Pendant Display
610.007 \$8.50



Drop Earring Display
610.009 \$9.50



Stud Earring Display
610.059 \$15.25



3-Pendant Display
610.008 \$14.95



Small Pendant Bust
610.055 \$22.95



5-Ring Display
610.054 \$19.50



36-Ring Display
610.005 \$7.50



610.041 -
610.043



610.038 -
610.039

Large Necklace Bust

3 colors; Black and Gray are Velvet, Rose is Shadow Suede.
8¹/₄"H x 6¹/₂"W.

610.041	Desert Rose	\$46.95
610.042	Black	\$46.95
610.043	Gray	\$46.95

Small Necklace Bust

Measures 6¹/₂"W x 4"H. Available in Black or Gray Velvet.

610.038	Black	\$34.95
610.039	Gray	\$34.95



610.049



610.044
610.045

Bracelet Display

Black velvet bar measures 8" long x 5¹/₄" wide x 2³/₄" high.

610.049		\$25.50
---------	--	---------

Bangle Tray

Measures 8¹/₄" x 4³/₄". Outer case is black Choose black or gray interior.

610.044	Black	\$32.95
610.045	Gray	\$32.95



610.017
610.018

Bracelet Display

Measures 2¹/₈" x 8". Available Black or Gray Velvet.

610.017	Black	\$9.95
610.018	Gray	\$9.95

Watch Display Tray

Classic display tray has 12 black velvet holders for displaying and storing wristwatches. Measures 14³/₄" x 8¹/₄" x 1³/₈" Deep. Sturdy wood tray covered with textured vinyl.

610.155		\$67.95
---------	--	---------



610.155

Watch/Bracelet Display Pillow

Black Velvet pillow is a simple but elegant way to display a bracelet or watch. Measures 3" x 3".

610.001		\$2.10 ea 12 @ \$1.90 ea
---------	--	--------------------------



610.001



610.060
610.065

Bracelet/Watch Stand

Measures 3"H x 3¹/₄"W with a 2" square base. Available in Black and Gray Velvet.

610.060	Black	\$14.95
610.065	Gray	\$14.95

Necklace Display

Black velvet covered metal easel measures 7"W x 8½"H.

610.087 **\$14.50**

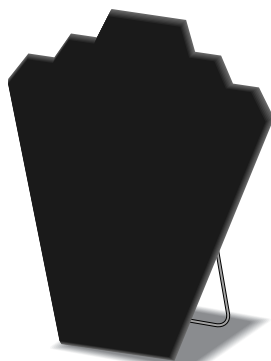

610.087

Necklace Displays

Black velvet-like covered heavy chipboard. The look and feel of velvet without the high cost. Easel back.

610.578 13½" x 7½" **\$11.50**

610.579 8½" x 6½" **\$10.25**

610.580 6" x 4½" **\$5.75**



610.578 - 610.580



610.582

Chain Display

Black velvet with 15 hooks for neckchains. Easel back. 15" x 12".

610.582 **\$19.95**

Chain Board

Black flock on cardboard easel display measures 12¾"H x 11¾"W.

610.095 **\$7.25**



610.015

Earring Tree

Easel display measures 9"H x 6½"W. Holds 6 pair. Black flock on cardboard.

610.015 **\$4.25**

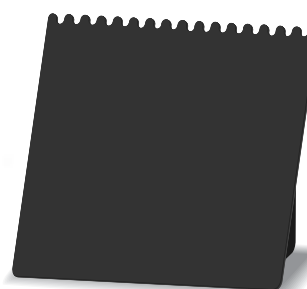

610.095

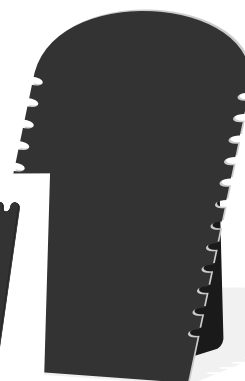

610.016

Chain or Pendant Easel

Measures 13¾"H x 7½"W. Holds 12 necklaces. Black flock on cardboard.

610.016 **\$4.50**

Linon Necklace Easel

Natural linen easel for necklaces. 9½" x 3¾" x 11"H.

610.593 **\$10.50**



610.593

Linon Pad for Display Tray

Natural linen pad fits trays like our #610.537 on page 359. 14½" x 7½".

610.592 **\$4.25**



610.592

Linon Earring/Pendant Display

Natural linen stand for a pair of earrings or a pendant. 2¾" x 1½" x 3".

610.591 **\$4.25**



610.591

Linon Ring Display

Natural linen tray with slots for 18 rings. 8" x 4½" x 1¼".

610.594 **\$11.50**



610.594

Linon Ring Display

Natural linen stand for 5 rings. 5¼" x 3¾".

610.156 **\$23.75**



610.156

Attractive Displays Help You Sell More

Earring Tree

Soft covered display measures 8³/₂"H x 8³/₄"W x 4¹/₂"D. Holds 12 pair. Available in 3 colors: Black or Gray Velvet, and Desert Rose Shadow Suede.

610.020	Black	\$41.95
610.021	Gray	\$41.95
610.022	Rose	\$41.95

Large Drop Earring Display

Ideal for larger drop earrings. Measures 3³/₄"H x 2"W x 2"D. Available in 3 colors; Black and Gray are Velvet, Desert Rose is Shadow Suede.

610.026	Black	\$10.50
610.027	Gray	\$10.50
610.028	Rose	\$10.50



610.020 -
610.022



610.026 -
610.028



610.013



610.575



610.574



610.700

Plexiglass Earring Display

Translucent plexiglass stand has brass hooks to hold 12 pairs of earrings or charms. 7⁵/₈" wide x 4¹/₂" high x 2¹/₈" deep.

610.700	\$6.50
----------------	---------------

Velvet Earring Tree Stands

This stand is a simply elegant way to display earrings, and it's easy to set up anywhere. Black velvet.

610.013	\$4.75
----------------	---------------

Velvet Necklace T-Bar

Elegant Black Velvet T-bar shows off gold chain, pearls and all types of necklaces. Measures 12" x 12¹/₂".

610.575	\$43.95
----------------	----------------

Velvet Bracelet T-Bar

Handsome black velvet T-bar is perfect for displaying all types of bracelets. Enhances pearls, gold and silver. 8" wide x 5¹/₄" high. Matches our necklace T-bar 610.575.

610.574	\$12.95
----------------	----------------

Earring Display Case

Classic case has 18 black velvet die-cut inserts for displaying and storing earrings. Measures 14³/₄" x 8¹/₄" x 1¹/₂". Sturdy wood case covered with textured vinyl. Hinged lid with snap closures.

610.153	\$46.75
----------------	----------------



610.153

Black Display Hand

Small relaxed plastic hand is the perfect way to display rings, pearl strands, gold chains, etc. Measures 7½" long.

610.313 **\$9.75**



610.313

Magnifying Mirror

Classic mirror ideal for use in your store and at home. It's a regular mirror on one side; flip it over and it's a 2X magnifying mirror on the other. Frame swivels at any angle. Chrome plated stand. 7½" diameter.

610.666 **\$18.75**



610.666

610.668

Large Oval Mirror

This beautiful, rimless mirror with beveled edges stands 18" high. Mirror features a chrome stand, 10½" wide by 14¾" tall. This is an excellent quality rimless mirror which works perfectly on any countertop. Can tilt back a full 45° for viewing of earrings, necklaces, etc.

610.668 **\$46.25**

Folding Mirror

Elegant black faux leather folding mirror adjusts to multiple positions and folds flat for easy storage and transport. 8" x 12" x ¾".

610.667 **\$15.95**

610.667



Bracelet Buddy gives you an extra hand to fasten awkward chains

An extra hand for chain-type bracelets that are impossible to close without someone's help. Gently holds one end of the bracelet securely in place while you fasten the clasp with your free hand. Lightweight polymer silver or gold plated, 7" long. A great add-on sales item for tennis and chain bracelets.

830.007 Gold Tone **\$6.50 ea 12 @ \$5.75 ea**

830.008 Silver Tone **\$6.50 ea 12 @ \$5.75 ea**

830.007

830.008





610.502 -
610.518

Basic Black Ring Trays and Cases

Classic black ring trays and cases gets you results in sales. The black velvet of the trays and cases in this popular line proves that effective displays need not be expensive. The line include trays and cases for 12, 24, 36 and 72 rings. Cases are wood, covered in textured black vinyl, with simply designed metal latches. Slotted black foam under the velvet inserts holds rings firmly in place. Covers are lined in black satin. Trays have decorative gold tooling around the edges.

No.	Type	Price Each
610.502	12 Ring Tray	\$9.95
610.504	24 Ring Tray	\$12.95
610.506	36 Ring Tray	\$18.95
610.508	72 Ring Tray	\$25.95
610.512	12 Ring Case	\$16.95
610.514	24 Ring Case	\$24.95
610.516	36 Ring Case	\$29.95
610.518	72 Ring Case	\$39.50

610.023 -
610.025



Oval Ring Display

Oval display measures 5¼" x 4" x ¾". Displays 7 rings. 3 colors; Black and Gray are Velvet, Rose is Shadow Suede.

610.023	Black	\$26.95
610.024	Gray	\$26.95
610.025	Rose	\$26.95

610.012



Velvet Ring Display

This elegant black velvet display holds 12 rings in satin lined slots. 6" x 3" x 1"

610.586		\$19.95
---------	--	---------

610.586

Velvet Ring Stand

This stand is a simply elegant way to display a ring, and it's easy to set up anywhere. Black velvet.

610.012		\$3.50
---------	--	--------



610.100



610.106



610.107

Sold Plugs

Oval plugs stamped "SOLD" or blank fill spaces in ring trays.

610.100	Black Blank	\$3.75 dz
610.106	Black with Gold "Sold"	\$3.75 dz
610.107	White with Black "Sold"	\$3.75 dz

Vertical Bracelet Display Pole

Black Velvet display is ideal for displaying stretch bracelets. 13" High, 2¼" diameter pole.

610.595		\$11.50
---------	--	---------

Velcro Tray Pad

Black pad has a loop surface for holding items with Velcro hook side. 7½" x 14" fits our standard trays 610.537 and 610.553.

610.530	7½" x 14"	\$6.50
610.531	6¾" x 7¾"	\$4.95



610.595



610.530

610.531

Covered Utility Tray

Black tray has padded lid with snaps.
Standard 14 $\frac{3}{4}$ " x 8 $\frac{1}{4}$ ". Prices per tray (each).

610.558 1" Deep **\$21.95** 25 @ **\$19.75** 50 @ **\$17.50**

610.559 1 $\frac{1}{2}$ " Deep **\$24.95** 25 @ **\$22.50** 50 @ **\$19.95**

Open Utility Tray

Black open utility tray. Standard size 14 $\frac{3}{4}$ " x 8 $\frac{1}{4}$ ".
Use with any 14 $\frac{1}{4}$ " insert on this page.

610.537 1" Deep **\$5.75**

610.553 1 $\frac{1}{2}$ " Deep **\$6.95**

Tray with Pendant Pads

Black tray with 24 pads for pendants. Standard size
14 $\frac{3}{4}$ " x 8 $\frac{1}{4}$ ". Pads measure 2 $\frac{1}{8}$ " x 1 $\frac{3}{4}$ ".

610.032 Black Velvet **\$59.95**

610.033 Gray Velvet **\$56.95**

610.034 Desert Rose Shadow Suede **\$56.95**

Velcro Tray Pads

Black Velcro pad for sticking items with velcro hook
side. Standard fits 610.537 & 610.553 trays. Two sizes.

610.530 Standard Size Pad 7 $\frac{1}{2}$ " x 14" **\$6.50**

610.531 Half Pad 7 $\frac{3}{4}$ " x 6 $\frac{3}{4}$ " **\$4.95**

Velvet Tray Pads

Black velvet tray pad measures 7 $\frac{3}{4}$ " x 14 $\frac{1}{4}$ ".

610.538 **\$4.95 ea** 25 @ **\$4.50ea** 50 @ **\$3.95ea**

Velour Foam Ring Pad

Black velour foam pads are die cut for 72 rings. 7 $\frac{3}{4}$ " x
14 $\frac{1}{4}$ " fits standard tray. Straight or staggered rows.

610.554 Straight Rows **\$3.25**

610.555 Staggered Rows **\$4.25**

Black Plastic Tray Inserts

Inserts measure 7 $\frac{1}{2}$ " x 14 $\frac{1}{4}$ " overall to fit black trays.

610.154 15 Compartments 2 $\frac{3}{4}$ " x 2 $\frac{1}{2}$ " **\$10.95**

610.048 36 Compartments 1 $\frac{1}{4}$ " x 1 $\frac{1}{4}$ " **\$11.95**

Deluxe Black Velvet Tray Insert

Velvet covered heavy board material. 8 Compartments
3 $\frac{1}{4}$ " x 3 $\frac{1}{2}$ ". Overall 7 $\frac{1}{2}$ " x 14 $\frac{1}{4}$ ", to fit black trays.

610.152 **\$32.95**

Watch/Bracelet Tray Pad

Tray pad has 12 spaces for watches or bracelets.
7 $\frac{3}{4}$ " x 14 $\frac{1}{4}$ " overall to fit black trays.

610.029 Black Velvet **\$32.95**

610.030 Gray Velvet **\$32.95**

610.031 Rose Shadow Suede. **\$32.95**

24 Space Tray Pad

24 spaces 2" x 1 $\frac{3}{4}$ " for jewelry. 7 $\frac{3}{4}$ " x 14 $\frac{1}{4}$ " x $\frac{1}{2}$ " overall
to fit black trays.

610.035 Desert Rose Shadow Suede **\$37.95**

610.036 Black Velvet **\$37.95**

610.037 Gray Velvet **\$37.95**

Foam Tray Liner Sheet

Great double-sided black velvet-like surface. Lay in full
sized display trays to protect gem stones or beads. Can
be cut or folded to protect jewelry or trimmed to fit odd
sized trays. Standard tray size, 14 $\frac{1}{8}$ " x 7 $\frac{7}{8}$ ".

610.543 **\$9.95 dz**



610.537
610.553



610.558
610.559

610.032 - 610.034



610.538

610.554
610.555



610.154

610.048



610.152

610.029
610.030
610.031

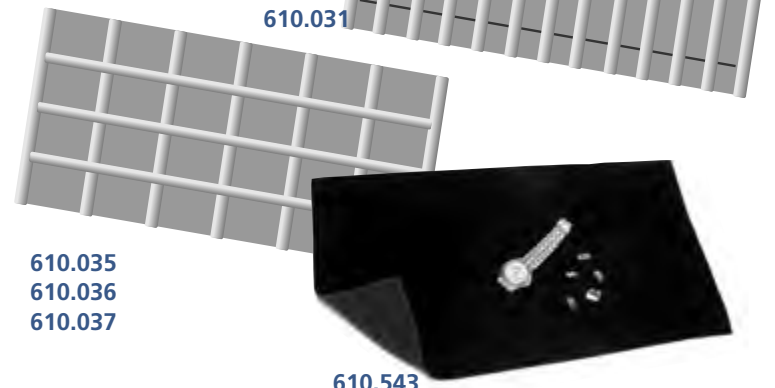

610.035
610.036
610.037

610.543

DISPLAY FOLDERS & BOXES

Necklace Folder

Ideal for presentation, storage and protection of jewelry, especially for travel. Black leatherette outside with black satin lining. 5¹/₂" x 6³/₄".

610.584 **\$4.75 ea 6 @ \$4.25 ea**



610.584



610.585

Large Gray Necklace Box

Enhance your necklace displays with this leatherette box. Gray with gold trim accents. 6¹/₄" x 9" x 1³/₄".

610.585 **\$7.50 ea 6 @ \$6.75 ea**

Chain Roll

Soft black vinyl roll has 16 removable snaps to hold pearl strands or chains. 26" x 13".

610.576 **\$19.95**



610.576

Necklace Folder provides excellent protection

Vinyl outside, black velvet inside. Includes 16 snap loops and foam insert. Zipped folder 14" x 10" x 1".

790.001 **\$18.25**



790.001

610.061



Tray Insert with Round Spaces

Black flocked insert has fifty 1¹/₄" diameter circular spaces for storing and displaying gems and jewelry. Measures 14³/₄" x 7³/₄" x 3/4" and fits standard trays.

610.061 **\$10.50**

Watch Case

Compact zippered case holds 20 wrist watches. Smooth black vinyl case measures 14" x 10" when closed. Black suedine lined with foam pad for added protection.

790.000 **\$19.95**



790.000

Leatherette Case with Detachable Clear Acrylic Lid

This case displays and protects your treasures and allows viewing through the clear top. Measures 14³/₄" x 8¹/₂" x 1¹/₂". Lid is held in place with magnets and is completely removable.

610.501 **\$11.95**



610.501

Jewelry Carrying Case

Soft bag holds standard 14³/₄" x 8¹/₄" jewelry and ring trays. Durable, light-weight case is made of black water resistant fabric with a top handle and a removable shoulder strap. Measures 18" x 9" x 15" and folds completely flat for easy storage. Zippered front compartment is perfect for documents or necklace folders.

610.099 **\$26.75**



610.099

Portable Storage System

Includes 5 stackable 6¹/₂" x 1¹/₄" donut storage units, each with 5 storage compartments. Made of break and crack resistant translucent plastic. Perfect for beaders.

150.010 **\$8.75**



150.010

White on White Gemstone Case

Contains 50 round 26mm diameter jars for small or melee stones. White plastic tray and clear plastic boxes. Foam pads in tray and boxes are white. Tray is 14³/₄" x 8¹/₄".

610.816 **\$10.95**



610.816

Stackable Stone Case

Contains 50 round boxes for small or melee stones. Black tray and clear boxes are made of high impact plastic. Foam pads in tray and boxes are black. Tray is 14³/₄" x 8¹/₄".

610.800 **\$10.95**



610.800

Gem Jars Display and Protect Loose Stones

Efficient way to display, protect and store loose gemstones. Clear styrene jars are 1³/₈" in diameter and available with Black or White flocked pads.

610.780 Black **\$4.95 dz**

610.781 White **\$4.95 dz**

610.782 Labels, pk of 750, 1" diam.w/ Fine Point Pen **\$4.95**



610.780

610.781

610.782

CUT _____
 CLARITY _____
 PRICE/CARAT _____
 PRICE OF THIS STONE _____
 REGISTRY NO. _____
 WEIGHT _____
 COLOR _____

Cut crystals add sparkle to your displays, and they make great gift items

Get attention and increase traffic with these dazzling display diamonds. Made from mineral glass crystal, these gems really sparkle. Prices are Jewelers' Costs.



Clear Crystal Diamonds

610.315	40mm	\$4.00
610.316	50mm	\$5.50

Blue Crystal Diamonds

610.339	20mm	\$3.25
610.338	40mm	\$4.95

Pink Crystal Diamonds

610.333	20mm	\$3.25
610.332	40mm	\$4.95
610.331	50mm	\$5.95

Yellow Crystal Diamonds

610.336	20mm	\$3.25
610.335	40mm	\$4.95
610.334	50mm	\$5.95



Golf Ball 40mm actual size
610.317 \$6.50

Display crystals attract attention to your jewelry cases, and they make great gift items or sale add-ons!

Get attention and increase sales with seasonal or themed crystal display accent pieces. These crystal pieces and displays bring sparkling light into your product display areas. Prices are Jewelers' Costs.



Snowman
2 1/8" (55mm) High
610.323 \$2.95

Teardrop with hole for hanging
1 1/2" (38mm) High
610.325 \$2.95



Baby Booties
25mm actual size
610.318 \$4.00

Brass Crystal/Egg Stand

Twisted brass wire crafted to enhance display crystals and other objects. Stand measures 1 1/2" wide and 1 1/2" high. Ball not included.

610.328 Wire Stand **\$3.35**



610.328



610.326

Pewter Display Stand

Pewter stand is ideal for 50mm sphere and hen sized eggs.

610.326 Pewter **\$5.50**

Prices are Jewelers' Costs for approved retailers.

Prices are wholesale, for approved retailers only.



Mini Heart Tiara 1 1/2"
39-20 \$6.75



Aladdin Tiara 2"
39-21 \$7.00



Crystal Bloom Tiara 1 1/2"
39-22 \$12.00



Petite Princess Tiara 1 1/2"
39-23 \$7.45



Half Fleur Tiara 1 3/4"
39-24 \$8.00



Heart Waves Tiara 2"
39-25 \$7.95



Bursting Heart Tiara 1 3/4"
39-26 \$11.25



Mini Crystal Tiara 1 1/2"
39-27 \$6.25

WATCH WINDERS, BOXES & DISPLAYS

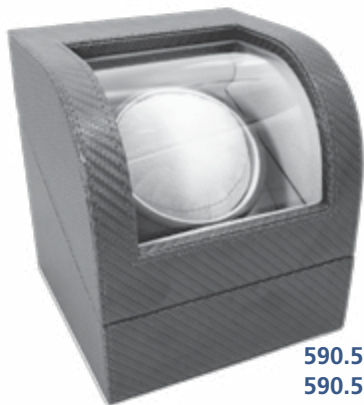

590.550
590.551

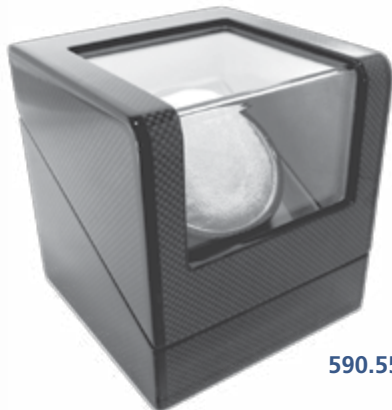

590.553

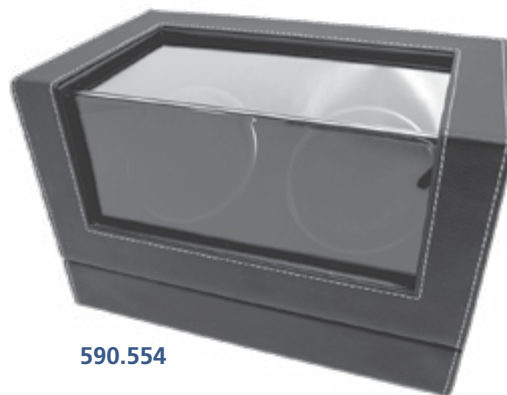

590.554

Classy Watch Winders

Hinged watch winders in beautiful boxes with clear tops. Powered by AC adapter.

590.550	Red checked leather, 6" x 5 3/4" x 5 3/4"	\$79.95
590.551	Bronze checked, 6" x 5 3/4" x 5 3/4"	\$79.95
590.552	Polished Cherry Wood, 5" x 5" x 5"	\$99.95
590.553	Charcoal checked, 6" x 6" x 5 1/2"	\$109.95
590.554	Black leather Dual	\$129.95



670.513

Faux Leather Box For 6 Watches

Classic style black faux leather with stitching and lock with key. Faux suede interior holds six watches on black padded puff holders.

670.513

\$25.75

Three Watch LED Charging Box

High gloss box holds three watches and features LED lights in the lid. Plug in the box and charge your watches with the lid open or closed.

670.512

\$62.95



670.512



790.004

790.005



Six Pillow Watch Tray

Black leather-like oval pillows sit slanted in 8" x 6 3/4" tray to display up to six watches.

790.004

\$16.95

Twelve Pillow Watch Tray

Display up to 12 watches on plump leather-like pillows in this 14" x 9-1/2" watch tray.

790.005

\$24.95



670.521

Luxury Lacquered Wood Watch Box

Beautifully hand crafted solid wood with a deep reddish brown color and multiple layers of clear mirror-like finish. Smooth cream colored plush interior. Holds three watches or bracelets. 8" x 5" x 3 1/2".

670.521

\$54.95

Cylinder Watch Winder

Extremely quiet cylinder winder features a large transparent window dust cover and two winding modes. Lightweight ABS black matte plastic winder is ideal for travel.

- 5-3/4"High x 3-5/8"Diameter.
- 3-Way switch: Standby 2.5 Hour/Off/Standby 6.5 Hour.
- Rotates about 7 cycles/minute.
- Powered by 4-AAA batteries or included 110/120V AC adapter.
- Operates about 4 days on alkaline batteries.

Two Timer Functions:

- 15 minutes counter-clockwise, stop 2 seconds, 15 minutes clockwise, standby 2.5 hours, repeats.
- 15 minutes counter-clockwise, stop 2 seconds, 15 minutes clockwise, standby 6.5 hours, repeats.

590.971 *Suggested Retail \$129.90 - Jeweler's Cost \$64.95*



590.971

Dual Head Automatic Watch Winder

This easy to operate winder for two watches features Clockwise, Auto (Bi-directional) and Counter-Clockwise functions by a simple switch. Price is suggested retail.

- Lightweight plastic case with clear acrylic portal style lenses in hinged door.
- Measures 10" High, Base is 5½" Wide x 6⅝" Deep.
- Adjustable spring loaded holders accommodate large and small watches, and adapters are included to hold extra large watches.
- Quality Japanese motor is extremely quiet.
- Power by AC Adapter (included).

Timer Programs:

- Mode A - Auto rotate for 33 seconds, rest for 12 minutes.
- Mode B - Auto rotate for 10 minutes, rest for 90 minutes.
- Mode C - Auto rotate for 30 minutes, rest for 3 hours.
- Mode D - Auto rotate for 1 hour, rest for 3 hours.

590.965 *Suggested Retail \$207.95 - Jeweler's Cost \$103.95*



590.965



Our selection of watch winders is constantly changing with the latest styles and technologies.

Visit casker.com or subscribe to our mailing list to stay current!



820.202
820.203

Pocket Watch Stand

Highly polished display stand for pocket watch or ornament. Weighted base, 5" tall.

820.200	Chrome	\$16.75
820.201	Brass	\$16.75



820.212

Solid Brass Pocket Watch Stand

Display stand is perfect for the treasured double watch case. Adjusts to fit most sizes.

820.212		\$14.50
---------	--	---------



820.200
820.201

Arched Pocket Watch Stand

Highly polished display stand for pocket watch or ornament. Weighted base, 5" tall.

820.202	Chrome	\$18.75
820.203	Brass	\$18.75



820.603

Lucite Pocket Watch Stand

Displays the smallest woman's watch to largest gentleman's. Takes watches open or closed. Stand is hand fashioned from lucite with high quality craftsmanship. 1 3/4" high.

820.603		\$2.75
---------	--	--------



820.691Y
820.691W

Mirror Base Stand

Brass or nickel finish wire with mirror base. 6 3/4" tall.

820.691Y	Brass	\$5.50 ea	3 @ \$4.95 ea
820.691W	Nickel	\$5.50 ea	3 @ \$4.95 ea



610.089

Translucent Wristwatch Display Stand

Set of 12 translucent nylon stands. Simple and unobtrusive, it bends to fit any wristwatch.

610.089		\$13.25
---------	--	---------



610.066

Display Stand for Balls, Geodes, etc.

Clear acrylic stand will display any number of items, ball ornaments, geodes, paperweights, even hockey pucks. 2 1/2"W x 3 1/4"D x 1 1/4"H (too big for a baseball).

610.066		\$3.95
---------	--	--------

Large Pocket Watch Dome with Wood Base

Available with one or two hooks for watches or ornaments.
Solid wood base. Glass Dome measures 7" x 4".

For One Watch:

500.910.0 Oak
500.911.1 Walnut
500.912.2 Mahogany
500.916.6 Cherry

\$21.95 ea

For Two Watches:

500.950.0 Oak
500.951.1 Walnut
500.952.2 Mahogany
500.956.6 Cherry

\$22.95 ea

500.329 Replacement Glass Dome 7" x 4" **\$9.95**

Small Pocket Watch Dome with Wood Base

Glass dome 4¼" x 3" with solid wood base and brass hook for pocket watch. Available in five hardwoods.

500.900.0 Oak **500.903.3** Hickory
500.901.1 Walnut **500.904.4** Sycamore
500.902.2 Mahogany **500.906.6** Cherry

\$15.95 ea **3 @ \$14.50 ea** **12 @ \$13.50 ea** (3 or 12 assorted)

500.330 Replacement Glass Dome 4¼" x 3" **\$8.75**

Wristwatch Dome with Wood Base

Glass dome 4¼" x 3" with solid walnut base and plastic stand for wristwatch.

500.205 **\$16.75 ea** **3 @ \$15.25 ea**

Glass Domes make great gifts, and are ideal for store display of watches, figurines & ornaments.

400 Day Glass Clock Covers

Crystal clear with no distortions or blemishes.
Smooth edges.

730.302 7"H x 4"D **\$10.95**

730.303 11"H x 5½"D **\$14.25**



500.910.0 -
500.916.6



500.900.0 -
500.906.6



500.205



730.303

We're always adding new products for jewelers and watchmakers. Visit our website or subscribe to our mailing list to stay current on the latest innovations and useful tools and supplies!

Pocket Watch Bows

Round Bows

May be spread to accept case much larger than opening. Sold individually.

\$12.50ea 3@\$12.00ea

Number	Color	Overall Size mm	Watch Size
57-213-11	YGP	13	00
57-213-12	NP	13	00
57-215-11	YGP	15	0
57-215-12	NP	15	0
57-217-11	YGP	17	6
57-217-12	NP	17	6
57-219-11	YGP	19	12
57-219-12	NP	19	12
57-220-11	YGP	20	16
57-220-12	NP	20	16
57-222-11	YGP	22	18
57-222-12	NP	22	18



Oval Bows

\$7.95ea 3@\$7.50ea

Number	Color	Open mm	Overall mm	Watch Size
57-112-11	YGP	6.0	12	00
57-112-12	NP	6.0	12	00
57-114-11	YGP	7.0	14	0
57-114-12	NP	7.0	14	0
57-116-11	YGP	8.0	16	6
57-116-12	NP	8.0	16	6
57-118-11	YGP	9.5	18	12
57-118-12	NP	9.5	18	12
57-120-11	YGP	10.0	20	16
57-120-12	NP	10.0	20	16
57-122-11	YGP	10.0	22	18
57-122-12	NP	10.0	22	18



Symmetrical Bows

\$12.95ea 3@\$11.75ea

Number	Color	Open mm	Overall mm	Watch Size
57-312-11	YGP	4.0	12	00
57-312-12	NP	4.0	12	00
57-314-11	YGP	7.5	14	0
57-314-12	NP	7.5	14	0
57-316-11	YGP	8.5	16	10
57-316-12	NP	8.5	16	10
57-318-11	YGP	9.5	18	12
57-318-12	NP	9.5	18	12
57-320-11	YGP	10.0	20	16
57-320-12	NP	10.0	20	16
57-322-11	YGP	10.0	22	18
57-322-12	NP	10.0	22	18



Measure watch to determine bow millimeter opening



Pocket Watch Chains, Plated Assortment

Our card of Waldemar pocket watch chains includes 9 Yellow and 3 White plated in assorted styles and weights. Each chain is 14" long and has a large 18mm spring ring and swivel. Price per dozen. Sold by the dozen only.

690.004

\$62.95



Pocket Watch Chain

12" Waldemar. Price is keystone.

41-6008-11 Yellow **\$5.95**

41-6008-12 White **\$5.95**



Pocket Watch Chains, Leather

Braided leather pocket watch chains with double loop, 10" long. Black & Brown. Price each.

820.604.1 Black **\$6.25**

820.604.2 Brown **\$6.25**



Pocket Watch Holder

Genuine leather holder protects pocket watch. Snap front and belt loop. Small size 56mm x 70mm. Price is keystone.

680.058 56mm x 70mm Black **\$8.75**

680.059 65mm x 75mm Black **\$9.50**

680.061 56mm x 70mm Brown **\$8.75**

680.062 65mm x 75mm Brown **\$9.50**

680.063 56mm x 70mm Black Eagle **\$9.50**

680.064 65mm x 75mm Black Eagle **\$9.50**

See page 395 for pocket watch crowns.

Cas-Ker carries a complete line of Jeweler's Findings. Request our catalog #900.106 for ring guards, clasps, chains, mountings, settings, and more.



14K Spring Ring Assortment

14K Gold Assorted Yellow & White. In clear compartment box 22 piece assortment includes:

- 4.5mm (2 Yellow, 1 White),
- 5.0mm (6 Yellow, 1 White),
- 5.5mm (6 Yellow, 1 White),
- 6.0mm (2 Yellow, 1 White),
- 7.0 (1 Yellow), and 8.0mm (1 Yellow)

14-111

CALL FOR PRICE 1-800-487-0408



YGF & SS Spring Ring Assortments

Contains assorted Yellow Gold Filled, Sterling Silver or both in 5, 5.5, 6, 7, 8, 9, and 10 mm. In clear compartment box.

53-134 YGF & Sterling Assortment, 34 pieces **\$32.50**

53-134-7 All YGF Assortment, 32 pieces 5-8mm **\$30.95**

53-134-8 All Sterling Assortment, 32 pieces **\$30.95**



14K Jump Ring Assortment

All 14K Yellow or All White Round and Oval Jump Rings in clear compartment box. 52 piece assortment includes:

- 12 - 3 x 0.5, 12 - 4 x 3 x 0.5, 7 - 3 x 0.6, 7 - 4 x 3 x 0.6, 6 - 4.5 x 0.6,
- 4 - 5 x 4 x 0.7, 2 - 5 x 0.7, and 2 - 5 x 4 x 0.8.

15-111-1 14K Yellow Assortment

CALL FOR PRICE

15-111-2 14K White Assortment

CALL FOR PRICE



YGF & SS Round Jump Ring Assortment

144 assorted, five sizes each 1/20 12K YGF & Sterling 3.0, 4.25, 5.30, 4.90, and 5.50mm. Refills available.

51-120

\$24.95



YGF & SS Oval Jump Ring Assortment

144 assorted, 5 sizes each 1/20 12K YGF and Sterling 3.20 x 4.16, 3.53 x 5.05, 3.78 x 5.31, 4.40 x 4.95, and 4.42 x 6.22mm. Refills available.

51-121

\$24.95

Prices for gold items are subject to change with the gold market. Please call for current price. 1-800-487-0408.

Spring Rings

14KY Spring Rings



4.5mm 14K Yellow 15-107-045-1	5.0mm 14K Yellow 15-107-050-1	5.5mm 14K Yellow 15-107-055-1	6.0mm 14K Yellow 15-107-060-1	7.0mm 14K Yellow 15-107-070-1	8.0mm 14K Yellow 15-107-080-1	
-------------------------------------	-------------------------------------	-------------------------------------	-------------------------------------	-------------------------------------	-------------------------------------	--

CALL FOR PRICE 1-800-487-0408. *Prices for gold items fluctuate with the gold market.*

14KW Spring Rings

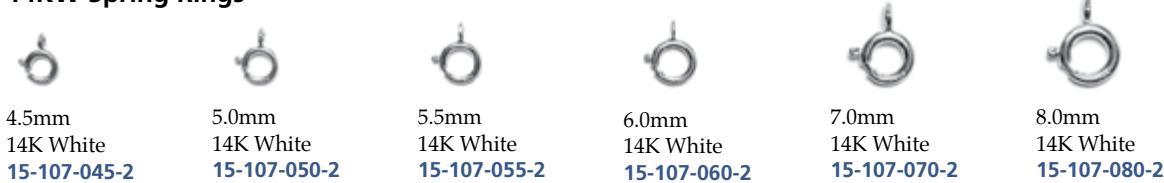

4.5mm 14K White 15-107-045-2	5.0mm 14K White 15-107-050-2	5.5mm 14K White 15-107-055-2	6.0mm 14K White 15-107-060-2	7.0mm 14K White 15-107-070-2	8.0mm 14K White 15-107-080-2	
------------------------------------	------------------------------------	------------------------------------	------------------------------------	------------------------------------	------------------------------------	--

CALL FOR PRICE 1-800-487-0408. *Prices for gold items fluctuate with the gold market.*

*Spring Rings
are Seamless
Hollow Tube*

10K Spring Rings

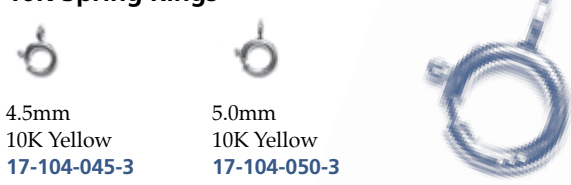

4.5mm 10K Yellow 17-104-045-3	5.0mm 10K Yellow 17-104-050-3
-------------------------------------	-------------------------------------

CALL FOR PRICE 1-800-487-0408.

14K Flat Spring Rings

Top ring is on same plane as bottom ring.



5.0mm 14K Yellow 15-152-050-1	5.5mm 14K Yellow 15-152-055-1
-------------------------------------	-------------------------------------

CALL FOR PRICE 1-800-487-0408.

Yellow Gold Filled Spring Rings

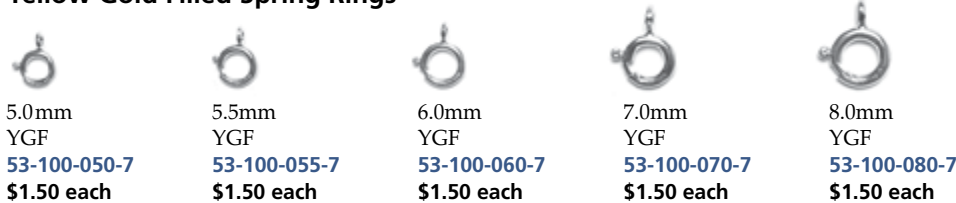

5.0mm YGF 53-100-050-7 \$1.50 each	5.5mm YGF 53-100-055-7 \$1.50 each	6.0mm YGF 53-100-060-7 \$1.50 each	7.0mm YGF 53-100-070-7 \$1.50 each	8.0mm YGF 53-100-080-7 \$1.50 each
---	---	---	---	---

Sterling Silver Spring Rings

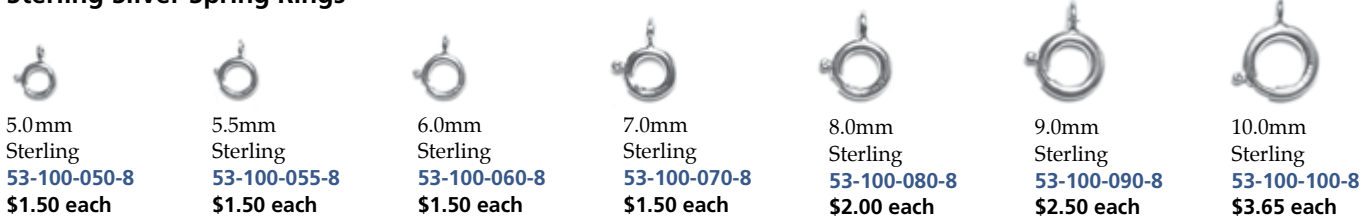

5.0mm Sterling 53-100-050-8 \$1.50 each	5.5mm Sterling 53-100-055-8 \$1.50 each	6.0mm Sterling 53-100-060-8 \$1.50 each	7.0mm Sterling 53-100-070-8 \$1.50 each	8.0mm Sterling 53-100-080-8 \$2.00 each	9.0mm Sterling 53-100-090-8 \$2.50 each	10.0mm Sterling 53-100-100-8 \$3.65 each
--	--	--	--	--	--	---

14K Chain Tag YGF & SS Chain Tags



8.0mm 14K Yellow 15-110-1	8.0mm YGF 52-105-7	9.5mm Sterling 52-105-8
---------------------------------	--------------------------	-------------------------------

CALL FOR PRICE 1-800-487-0408.
Prices for gold items fluctuate with the gold market.

Plated Sport Rings



18mm Diameter Yellow Plated 53-109-180-11 \$1.50 ea	18mm Diameter Nickel Plated 53-109-180-12 \$1.50 ea
--	--





Lobster Claw Clasps

14K Lobster Claw Clasps

14K Yellow and White Gold.

						
8.3 x 3.25 14K Yellow 15-132-083-1	10 x 4 14K Yellow 15-132-100-1	12 x 4.5 14K Yellow 15-132-120-1	14 x 5 14K Yellow 15-132-140-1	16 x 6 14K Yellow 15-132-166-1	16 x 8 14K Yellow 15-132-168-1	18 x 9 14K Yellow 15-132-189-1

CALL FOR PRICE 1-800-487-0408. Prices for gold items fluctuate with the gold market.





			
8.3 x 3.25 14K White 15-177-083-2	10 x 4 14K White 15-177-100-2	12 x 4.5 14K White 15-177-120-2	14 x 5 14K White 15-177-140-2

5% discount on three or more 10K and 14K Lobster Claw Clasps.

CALL FOR PRICE 1-800-487-0408. Prices for gold items fluctuate with the gold market.

10K Lobster Claw Clasps

10K Yellow Gold.

			
8.3 x 3.25 10K Yellow 17-107-083-3	10 x 4 10K Yellow 17-107-100-3	12 x 4.5 10K Yellow 17-107-120-3	14 x 5 10K Yellow 17-107-140-3

CALL FOR PRICE 1-800-487-0408.

Lobster Claw Clasps Assortment

18 piece assortment of yellow & white lobster claw clasps for necklaces and bracelets.
 2 pcs 8 x 3 White | 2 pcs 10 x 4 White | 2 pcs 12 x 4.5 White | 2 pcs 10 x 4 Yellow | 2 pcs 12 x 4.5 Yellow | 2 pcs 14 x 5 Yellow | 2 pcs 14 x 5 White | 2 pcs 16 x 6 White | 1 pc 16 x 8 White | 1 pc 18 x 9 White
53-120 \$46.95

YGF Lobster Claw Clasps

Yellow Gold Filled.







		
10 x 4 YGF 53-119-100-7 \$2.00	12 x 4.5 YGF 53-119-120-7 \$2.50	14 x 5 YGF 53-119-130-7 \$3.25

Quantity price breaks on 6 and 12 Sterling and YGF Lobster Claw Clasps.







Sterling Lobster Claw Clasps

Sterling Silver.

						
8.3 x 3.25 Sterling 53-119-083-8 \$1.50	10 x 4 Sterling 53-119-100-8 \$1.75	12 x 4.5 Sterling 53-119-115-8 \$2.75	14 x 5 Sterling 53-119-135-8 \$3.75	16 x 6 Sterling 53-119-166-8 \$4.75	16 x 8 Sterling 53-119-168-8 \$5.50	18 x 9 Sterling 53-119-189-8 \$8.35

14K Trigger Clasps

			
8mm 14K Yellow 15-126-080-1	11mm 14K Yellow 15-126-110-1	11mm 14K White 15-126-110-2	13mm 14K Yellow 15-126-130-1

CALL FOR PRICE 1-800-487-0408. Prices for gold items fluctuate with the gold market.

Plated Trigger Clasp

11.5mm Yellow Gold Plate 53-112-115-11 \$4.95 dz

Coin Mountings

Round Coin Edge Mountings

American

Coin	M/M	14K Yellow	Price	YGF	Price	Sterling	Price
Gold Dollar	13.0	18-201-1	CALL	35-201-7	\$13.00		
Gold Dollar	14.0	18-202-1	CALL	35-202-7	\$5.00		
Gold Dollar	15.0	18-203-1	CALL	35-203-7	\$6.25	35-203-8	\$ 7.25
Penny	19.0 x 1.50	18-205-1	CALL	35-205-7	\$13.00	35-205-8	\$8.55
Dime	18.0 x 1.20	18-206-1	CALL	35-206-7	\$7.75	35-206-8	\$7.00
\$2.50 Liberty	18.0 x 1.30	18-208-1	CALL	35-208-7	\$7.75		
Nickel	21.1 x 2.00	18-209-1	CALL	35-209-7	\$13.45	35-209-8	\$8.30
\$10 Liberty	27.0 x 2.00	18-215-1	CALL	35-215-7	\$12.00	35-215-8	\$8.65
Quarter	24.1 x 1.70	18-217-1	CALL	35-217-7	\$15.85	35-217-8	\$8.75
Quarter 14K White	24.1 x 1.70	18-217-2	CALL				
\$20	34.4 x 2.40	18-220-1	CALL	35-220-7	\$19.70	35-220-8	\$10.75
Half Dollar	30.5 x 2.10	18-222-1	CALL	35-222-7	\$17.75	35-222-8	\$9.85
Silver Dollar	38.2 x 2.80	18-224-1	CALL	35-224-7	\$25.35	35-224-8	\$12.75
Sacajawea Dollar	26.5 x 2.00	18-225-1	CALL	35-225-7	\$14.05	35-225-8	\$6.50
Susan B Anthony	26.5 x 2.00	18-225-1	CALL	35-225-7	\$14.05	35-225-8	\$6.50
\$2.50 Indian	17.8 x 1.14	18-4451-1	CALL	35-4451-7	\$8.55	35-4451-8	\$8.45
\$5 Liberty	21.6 x 1.60	18-4453-1	CALL	35-4453-7	\$13.50		
\$5 Indian	21.6 x 1.40	18-4462-1	CALL	35-4462-7	\$12.85		
\$10 Indian	27.0 x 2.00	18-4463-1	CALL	35-4463-7	\$10.70		
\$20 Miniature	9.1 x 0.80			35-4509-7	\$7.25		
\$3 Gold	20.7 x 1.02	18-4518-1	CALL	35-4518-7	\$10.00		
1/10oz Eagle \$5	16.5 x 1.30	18-4909-1	CALL	35-4909-7	\$14.25		
1/4oz Eagle \$10	22.0 x 1.65	18-4910-1	CALL	35-4910-7	\$13.95		
1/2oz Eagle \$20	27.0 x 2.18	18-4911-1	CALL	35-4911-7	\$18.00		
1oz Eagle \$50	32.7 x 2.85	18-4912-1	CALL	35-4912-7	\$16.95		
Silver Eagle	40.6 x 3.05			35-4908-7	\$21.25	35-4908-8	\$12.75
Marion Anderson	27.0 x 2.05			35-4561-7	\$7.50		
1oz Silvertowne	39.37 x 3.14			35-5104-7	\$19.55	35-5104-8	\$11.00



Australian

Coin	M/M	14K Yellow	YGF	Price	Sterling	Price
1/2oz Nugget	24.99 x 2.00				35-4972-8	\$8.00
\$2.00 Australian	20.40 x 2.82			35-5259-7		\$9.75

Austrian

Coin	M/M	14K Yellow	YGF	Price	Sterling	Price
1 Ducat	20.00 x 0.90	18-4418-1	CALL	35-4418-7		\$12.35
4 Ducat	39.55 x 0.76	18-4419-1	CALL	35-4419-7		\$9.75
20 Corona	21.40 x 1.60			35-4535-7		\$12.85
100 Corona	37.25 x 2.50			35-4455-7		\$12.50
8 Florin (20 Franc)	20.96 x 1.40			35-5000-7		\$9.75
Maria Theresa	41.50 x 2.50				35-4322-8	\$10.20



Canadian

Coin	M/M	14K Yellow	YGF	Price	Sterling	Price	
1/10oz Maple	16.00	18-4670-1	CALL	35-4670-7		\$8.45	
1/4oz Maple	20.00	18-4671-1	CALL	35-4671-7		\$10.00	
1/2oz Maple	25.10 x 2.20	18-4672-1	CALL				
1oz Maple	29.60 x 2.80	18-4466-1		35-4466-7	\$14.45	35-4466-8	\$10.70
Silver Dollar	36.00 x 2.80		CALL	35-227-7	\$25.50	35-227-8	\$6.75
\$2.00 Canadian	27.94 x 1.78			35-7349-7	\$10.00	35-7349-8	\$9.70

CALL FOR CURRENT PRICE ON GOLD ITEMS 1-800-487-0408. Prices for gold items fluctuate with the gold market.

Coin Mountings

Round Coin Edge Mountings

Chinese

Coin	M/M	14K Yellow	Price	YGF	Price	Sterling	Price
1/20oz Panda	13.90 x 1.15	18-4745-1	CALL	35-4745-7	\$6.75		
1/10oz Panda	17.95 x 1.05	18-4691-1	CALL			35-4691-8	\$7.00
1/4oz Panda	22.00 x 1.53	18-4701-1	CALL				
1oz Panda	32.05 x 2.07	18-4703-1	CALL			35-4703-8	\$10.25

English

Coin	M/M	14K Yellow	Price	YGF	Price	Sterling	Price
1/2 Sovereign	19.30 x 1.00	18-4529-1	CALL	35-4529-7	\$ 9.00	35-4529-8	\$9.10
1 Sovereign	22.02 x 1.52	18-4422-1	CALL	35-4422-7	\$11.15	35-4422-8	\$9.15
1 Pound	22.50 x 3.20	18-4729-1	CALL	35-4729-7	\$11.45		
2 Pound	28.45 x 2.54			35-7844-7	\$9.15	35-7844-8	\$9.25
Churchill Dollar	38.50 x 3.00			35-233-7	\$20.95	35-233-8	\$11.75

Europe

Coin	M/M			YGF	Price	Sterling	Price
One Cent	16.20 x 1.60			35-8583-7	\$10.25	35-8583-8	\$8.60
Two Cent	18.70 x 1.70			35-8584-7	\$11.15		
Five Cent	21.20 x 1.60			35-8585-7	\$9.75	35-8585-8	\$8.75
Ten Cent	19.70 x 1.90			35-8586-7	\$14.15	35-8586-8	\$9.00
Twenty Cent	22.60 x 2.10			35-8587-7	\$13.90		
Fifty Cent	24.20 x 2.30			35-8588-7	\$14.95		
One Euro	23.30 x 2.30			35-8589-7	\$14.50	35-8589-8	\$8.95
Two Euro	25.70 x 2.10			35-8590-7	\$16.45	35-8590-8	\$7.65

Italian

Coin	M/M	14K Yellow	Price	YGF	Price	Sterling	Price
20 Lira	21.34 x 1.52					35-7920-8	\$8.75
50 Lira	19.20 x 1.93					35-8280-8	\$8.25
100 Lira	18.31 x 1.91					35-8550-8	\$8.10
500 Lira	25.78 x 1.93	18-4698-1	CALL	35-4698-7	\$7.50	35-4698-8	\$9.45
1000 Lira	27.25 x 2.11			35-7814-7	\$6.80	35-7814-8	\$7.95

Mexican

Coin	M/M	14K Yellow	Price	YGF	Price	Sterling	Price
2 Peso	13.00 x 1.00	18-4413-1	CALL	35-4413-7	\$6.75		
2.5 Peso	15.50 x 0.80	18-4414-1	CALL	35-4414-7	\$7.10	35-4414-8	\$8.00
5 Peso	19.05 x 1.14	18-4415-1	CALL	35-4415-7	\$10.00	35-4415-8	\$8.55
10 Peso	22.50 x 1.40	18-4416-1	CALL	35-4416-7	\$10.00		
20 Peso	27.50 x 2.00	18-4417-1	CALL	35-4417-7	\$15.95		
50 Peso	37.00 x 2.60	18-4373-1	CALL	35-4373-7	\$8.65	35-4373-8	\$6.25
100 Peso	39.75 x 2.80					35-4438-8	\$11.75
Maximilian	10.00 x 0.55			35-4380-7	\$6.50		
1/4oz Mexican	23.00	18-4615-1	CALL	35-4615-7	\$10.00	35-4615-8	\$9.00
1/2oz Mexican	29.00	18-4616-1	CALL	35-4616-7	\$11.25		
1oz Mexican	34.50	18-4617-1	CALL	35-4617-7	\$14.25	35-4617-8	\$11.50
1 Ounza (Liberated)	35.99 x 3.53					35-4803-8	\$9.75
10 Peso Bi-Metal	28.02 x 2.28			35-7770-7	\$18.95	35-7770-8	\$9.95



Bails sold separately. Call for details.

CALL FOR CURRENT PRICE ON GOLD ITEMS 1-800-487-0408. Prices for gold items fluctuate with the gold market.

Neck Chains & Guard Chains

- 14K chains have 5mm spring rings.
- Sterling chains are rhodium plated.

Rope Chain 8R - 1.14mm Diameter

16"	Qual	Each	18"	Qual	Each	20"	Qual	Each	22"	Qual	Each	24"	Qual	Each
36-08-16-1	14KY	CALL	36-08-18-1	14KY	CALL	36-08-20-1	14KY	CALL	36-08-22-1	14KY	CALL	36-08-24-1	14KY	CALL
36-08-16-2	14KW	CALL	36-08-18-2	14KW	CALL	36-08-20-2	14KW	CALL	36-08-22-2	14KW	CALL	36-08-24-2	14KW	CALL
			38-08-18-7	YGF	\$6.25									
			38-08-18-8	SS	\$5.55									

Rope Chain 9R - 1.15mm Diameter

18"	Qual	Each	20"	Qual	Each	24"	Qual	Each
36-09-18-1	14KY	CALL	36-09-20-1	14KY	CALL	36-09-24-1	14KY	CALL
36-09-18-2	14KW	CALL	36-09-20-2	14KW	CALL	36-09-24-2	14KW	CALL

Rope Chain 10R - 1.30mm Diameter

16"	Qual	Each	18"	Qual	Each	20"	Qual	Each	22"	Qual	Each	24"	Qual	Each
38-10-16-7	YGF	\$7.46	38-10-18-7	YGF	\$8.50	38-10-20-7	YGF	\$9.50	38-10-22-7	YGF	\$9.65	38-10-24-7	YGF	\$10.25
38-10-16-8	SS	\$6.00	38-10-18-8	SS	\$7.95	38-10-20-8	SS	\$8.30	38-10-22-8	SS	\$8.85	38-10-24-8	SS	\$9.70

Rope Chain 11R - 1.60mm Diameter

18"	Qual	Each	20"	Qual	Each	24"	Qual	Each
36-11-18-1	14KY	CALL	-----			36-11-24-1	14KY	CALL
38-11-18-7	YGF	\$9.25	38-11-20-7	YGF	\$10.00	38-11-24-7	YGF	\$12.60
38-11-18-8	SS	\$7.50	38-11-20-8	SS	\$9.70	38-11-24-8	SS	\$10.65

Rope Chain 13R - 1.80mm Diameter

18"	Qual	Each	20"	Qual	Each	24"	Qual	Each	30"	Qual	Each
36-13-18-1	14KY	CALL	-----			36-13-24-1	14KY	CALL	-----		
			38-13-20-7	YGF	\$15.85	38-13-24-7	YGF	\$19.00	38-13-30-7	YGF	\$22.30
			38-13-20-8	SS	\$13.00	38-13-24-8	SS	\$14.75	38-13-30-8	SS	\$17.10

Rope Chain 22 - 2.89mm Diameter

18"	Qual	Each	20"	Qual	Each	24"	Qual	Each
38-22-18-7	YGF	\$24.00	38-22-20-7	YGF	\$27.50	38-22-24-7	YGF	\$32.00

Guard Chains

14K Yellow or White Gold Rope. 2 1/2" long.

14-102-1	14K Yellow	CALL
14-102-2	14K White	CALL

Rope Guard Chain YGF or Sterling. 3 3/8" long. 6-on Card.

58-101-7	YGF	\$8.00/6
58-101-8	Sterling	\$8.00/6

14K Yellow or White Gold Cable Link. 2 1/2" long.

14-101-1	14K Yellow	CALL
14-101-2	14K White	CALL

Fuller #18 1/2 Cable Link. YGF or SS. 3 3/8" long. 6-on Card.

58-100-7	YGF	\$6.00/6
58-100-8	Sterling	\$6.00/6

Cable Guard Chain with Spring Ring YGF. 2 5/8" long.

58-104-7	YGF	\$2.65
----------	-----	--------

CALL FOR CURRENT PRICE ON GOLD ITEMS 1-800-487-0408. Prices for gold items fluctuate with the gold market.

Neck Chains

Curb Chain 822 - 1.00mm Width

16"	Qual	Each	18"	Qual	Each	20"	Qual	Each
36-822-16-1	14KY	CALL	36-822-18-1	14KY	CALL	36-822-20-1	14KY	CALL
36-822-16-2	14KW	CALL	36-822-18-2	14KW	CALL	36-822-20-2	14KW	CALL
38-822-16-7	YGF	\$4.50	38-822-18-7	YGF	\$4.75			
38-822-16-8	SS	\$4.50	38-822-18-8	SS	\$4.75			

Curb Chain 1330 - 1.15mm Width

16"	Qual	Each	18"	Qual	Each	20"	Qual	Each	24"	Qual	Each
38-1330-16-7	YGF	\$8.00	38-1330-18-7	YGF	\$9.80	38-1330-20-7	YGF	\$10.75	38-1330-24-7	YGF	\$10.80
38-1330-16-8	SS	\$8.00	38-1330-18-8	SS	\$8.40	38-1330-20-8	SS	\$8.50	38-1330-24-8	SS	\$10.75

Curb Chain 1921 - 1.77mm Width

18"	Qual	Each	20"	Qual	Each	24"	Qual	Each
38-1921-18-7	YGF	\$16.50	38-1921-20-7	YGF	\$19.00	38-1921-24-7	YGF	\$20.25
38-1921-18-8	SS	\$11.00	38-1921-20-8	SS	\$11.00	38-1921-24-8	SS	\$13.15

Curb Chain 2915 - 2.70mm Width

20"	Qual	Each	24"	Qual	Each	30"	Qual	Each	30" Endless	Qual	Each
38-2915-20-7	YGF	\$36.80	38-2915-24-7	YGF	\$45.00	38-2915-30-8	SS	\$43.15	38-2915-30E-7	YGF	\$53.25
			38-2915-24-8	SS	\$25.00				38-2915-30E-8	SS	\$34.40

Curb Chain Stainless Steel 117 - 1.55mm Width, Bulk (not carded)

18"	Qual	Each
38-117-18-15	Steel	\$3.00

Curb Chain Stainless Steel 1758 - 2.85mm Width, Bulk (not carded)

20"/Spring Ring	Qual	Each	24" Endless	Qual	Each	27" Endless	Qual	Each
38-1758-20-15	Steel	\$5.75	38-1758-24E-15	Steel	\$4.00	38-1758-27E-15	Steel	\$4.25



Chain Extender

Yellow or White Plated Brass, 3" long Chain with a 5mm Bead.

53-123-11	Yellow	\$1.50 ea	3@\$0.75 ea
53-123-12	White	\$1.50 ea	3@\$0.75 ea



Seiko Type Safety Chain

Yellow or White, 3" long.

904.002	Yellow	\$11.95 dz
904.003	Rhodium	\$11.95 dz

CALL FOR CURRENT PRICE ON GOLD ITEMS 1-800-487-0408. Prices for gold items fluctuate with the gold market.

Round & Oval Jump Rings

Yellow & White Gold Filled and Sterling Silver.
Prices per dozen minimum; one size, one color.



O.D. MM	2.40	2.90	3.10	3.40	3.60	3.90	4.20	4.60	5.00	3.30	3.80	4.20
Wire MM	0.60	0.63	0.63	0.63	0.63		0.63	0.63	0.63	0.71	0.71	0.82
YGF												
Yellow Dozen		41-005-7 \$2.50	41-310-7 \$1.50		41-315-7 \$2.25			41-166-7 \$3.15	41-168-7 \$2.75	41-010-7 \$1.50		41-320-7 \$3.35
WGF												
White Dozen			41-310-9 \$1.50		41-315-9 \$1.50	41-162-9 \$1.50	41-164-9 \$1.50	41-166-9 \$1.50				
S/S												
Sterling Dozen	41-001-8 \$1.50	41-005-8 \$1.50	41-310-8 \$1.50	41-158-8 \$1.50	41-315-8 \$1.60	41-162-8 \$1.75	41-164-8 \$1.80	41-166-8 \$2.00	41-168-8 \$1.85	41-010-8 \$1.75		41-320-8 \$2.55

YGF												
O.D. MM	4.40	4.90	5.70	5.90	7.40	8.40	9.10	10.50	11.20	13.20		
Wire MM	0.92	1.01	1.01	1.16	1.16	1.051	1.63	1.30	1.60	1.60		
Yellow GF	41-020-7	41-025-7	41-330-7	41-030-7	41-340-7	41-345-7	41-045-7	41-347-7	41-348-7	41-349-7		
Dozen	\$3.95	\$6.20	\$3.50	\$7.25	\$8.00	\$9.00	\$13.75	\$16.75	\$26.25	\$27.15		

WGF												
O.D. MM			5.70	6.20	7.40	8.40	9.10	10.00	11.20			
Wire MM			1.01	1.01	1.16	1.051	1.63	1.00	1.60			
White GF			41-330-9	41-335-9	41-340-9	41-345-9	41-045-9	41-347-9	41-348-9			
Dozen			\$3.15	\$3.35	\$3.95	\$6.65	\$8.00	\$5.75	\$11.45			

S/S														
O.D. MM	4.40	4.70	4.90	5.70	6.20	5.90	7.40	6.70	8.40	8.10	9.10	10.50	11.20	13.20
Wire MM	0.92	0.92	1.01	1.01	1.01	1.16	1.16	1.051	1.051	1.45	1.63	1.30	1.60	1.60
Sterling	41-020-8	41-325-8	41-025-8	41-330-8	41-335-8	41-030-8	41-340-8	41-035-8	41-345-8	41-040-8	41-045-8	41-347-8	41-348-8	41-349-8
Dozen	\$2.95	\$2.50	\$4.30	\$5.50	\$5.50	\$5.00	\$6.25	\$5.00	\$6.20	\$9.35	\$11.50	\$10.25	\$16.25	\$18.35

Fuller Oval Jump Rings

Fuller Quality 1/80th Gold Filled Yellow or White, or Sterling Silver
Gold Filled prices per 3 dozen minimum one size, one color
Sterling prices per 1 dozen minimum one size, one color.



O.D. MM	4.0 x 3.0	5.0 x 4.0	6.0 x 4.4	6.5 x 4.4	4.8 x 3.8	5.2 x 4.6	6.9 x 5.2	7.3 x 5.2	9.2 x 6.2	7.9 x 5.8
Wire MM	0.63	0.71	0.71	0.71	0.92	1.01	1.16	1.16	1.30	1.45
YGF										
Yellow Dozen	41-119-7 \$3.20	41-174-7 \$6.50			41-111-7 \$3.45	41-107-7 \$3.90		41-096-7 \$6.75	41-091-7 \$11.95	41-095-7 \$11.50
WGF										
White Dozen	41-119-9 \$1.50	41-174-9 \$1.50	41-176-9 \$2.00	41-178-9 \$1.50					41-091-9 \$6.00	41-095-9 \$4.65
S/S										
Sterling Dozen	41-119-8 \$2.20	41-174-8 \$3.15		41-178-8 \$1.50	41-111-8 \$3.50	41-107-8 \$3.85	41-098-8 \$3.75	41-096-8 \$5.25	41-091-8 \$8.50	41-095-8 \$7.50

BUCKLE EXTENDER & BUTTERFLY CLASP ASSORTMENTS

Buckle Extender with Step 906.009

Extenders with a step feature for bracelet clasps. Contains 14 total, Yellow and White Stainless Steel, 1 each of 7 sizes.

906.009 Assortment \$27.95

White	Yellow	Size
906.009.12W	906.009.12Y	12mm
906.009.14W	906.009.14Y	14mm
906.009.16W	906.009.16Y	16mm
906.009.18W	906.009.18Y	18mm
906.009.19W	906.009.19Y	19mm
906.009.20W	906.009.20Y	20mm
906.009.22W	906.009.22Y	22mm

Refills- **\$3.25 ea 3@ \$3.00**



mm size = outside width

Buckle Extender 999.260

White and Yellow Stainless Steel. Assortment of 12 includes 1 each.

999.260 Assortment \$24.95

White SKU	Yellow SKU	Size
999.260.10W	999.260.10Y	10mm
999.260.12W	999.260.12Y	12mm
999.260.14W	999.260.14Y	14mm
999.260.16W	999.260.16Y	16mm
999.260.18W	999.260.18Y	18mm
999.260.20W	999.260.20Y	20mm

Refills **\$3.25 ea 3@ \$2.95 ea 12@ \$2.75 ea**



mm size = outside width

Buckle Extender 980.320

Stainless Steel assortment of 15, 2 each size white and 1 each size yellow folding extenders.

980.320 Assortment \$20.95

White	Yellow	Size
980.320.12	980.320.12G	12mm
980.320.14	980.320.14G	14mm
980.320.16	980.320.16G	16mm
980.320.18	980.320.18G	18mm
980.320.20	980.320.20G	20mm

Refills **\$2.25 ea 3@ \$1.95 ea**



mm size = outside width

Expandable Buckle Extender 999.280

Spring-loaded to stretch the extender length. White Stainless Steel or Yellow Plated Stainless with spring bars. Assortment of 12.

999.280 Assortment \$34.95

999.280.10W	1pc	White	10mm
999.280.12W	1pc	White	12mm
999.280.14W	1pc	White	14mm
999.280.16Y	1pc	Yellow	16mm
999.280.16W	2pcs	White	16mm
999.280.18Y	1pc	Yellow	18mm
999.280.18W	2pcs	White	18mm
999.280.20	1pc	Yellow	20mm
999.280.20Y	2pcs	White	20mm

Also available:

999.280.10Y	Yellow	10mm
999.280.12Y	Yellow	12mm
999.280.14Y	Yellow	14mm

Refills **\$4.25 ea 3@ \$3.75 ea**

999.099 Spring Bar Refills for 999.280
\$9.00 dz



mm size = outside width of top, inside width of bottom

Butterfly Clasp 980.300

Stainless Steel assortment contains 1 each of 7 different clasps, ladies' and men's.

980.300 Assortment \$46.95

Number	Style	Length	Width	Width at Band Connection
980.322L	Ladies'	34.0	11.0	4.0
980.322M	Men's	39.0	11.0	4.0
980.323	Ladies'	34.2	8.4	2.7
980.324	Men's	41.0	11.0	8.0
980.325L	Ladies'	35.4	8.7	4.4
980.325M	Men's	40.4	10.0	6.0
980.326L	Ladies'	37.8	10.0	3.4
980.326M	Men's	41.0	10.0	3.4
980.328	Ladies'	35.4	7.7	3.3

Refills - Ladies' **\$9.25 ea 3@ \$8.50 ea**
Refills - Men's **\$10.50 ea 3@ \$9.50 ea**



980.323
980.326L
980.326M



980.325L
980.325M
980.324



980.328

Butterfly Clasp 980.330 - 333

Stainless Steel butterfly clasp for men's and ladies' watches.

Number	Length	Width	Width at Band Connection
980.330	36.0	6.0	2.5
980.332	36.0	6.0	3.0
980.333	36.0	8.5	5.0

Refills - **\$9.25 ea**



Double-Press Butterfly Clasp 980.649

Stainless Steel, in 4 sizes.

980.649 Assortment \$46.95

Number	Length	Width	Width at Band Connection
980.649.04	35.0	8.0	4.0
980.649.05	35.0	9.0	5.0
980.649.06	40.0	12.0	6.0
980.649.07	39.0	11.0	7.0

Refills - **\$13.50 each**



SEIKO STYLE CLASP ASSORTMENTS

Clasp for Seiko w/ Safety Chain and Spring Bars 902.000



10 each men's and ladies' buckle spring bars, 6 each yellow and white safety chains, 1 each yellow and white foldover clasps.

902.000 Assortment \$33.95

White	Yellow	Size
902.000.50.15	902.000.50.13	5mm
902.000.60.15	902.000.60.13	6mm
902.000.70.15	902.000.70.13	7mm
902.000.80.15	902.000.80.13	8mm
902.000.90.15	902.000.90.13	9mm
902.000.15.15	*902.000.15.13	15mm

900.084.02 Men's Spring Bar
900.084.09 Ladies' Spring Bar

Additional Clasps available:

902.000.10.15	White	10mm
902.000.16.15	White	16mm
902.000.16T.13	Yellow	16mm-Thin
902.000.16T.15	White	16mm-Thin

Clasp Refills- **\$3.50 ea**

***Sorry, No Refills on 902.000.15.13**

Spring Bar Refills- **\$4.20 dz**

Safety Chain 904.002-003



Safety Chain

White	Yellow	Price
904.003	904.002	\$11.95/dz
904.003.100	904.002.100	\$79.95/100

Seiko Type Clasp for use with Screw 902.001



Link band center foldover clasps fit Armitron, Bulova, Elgin, Casio and other ladies' watches. Assortment of 8, 1 each size white and yellow.

902.001 Assortment \$15.95

White	Yellow	Size
902.001.20.12	902.001.20.11	2.0mm
902.001.30.12	902.001.30.11	3.0mm
902.001.40.12	902.001.40.11	4.0mm
902.001.50.12	902.001.50.11	5.0mm

Additional sizes available:

White	Yellow	Size
902.001.23.12	902.001.23.11	2.3mm
902.001.28.12	902.001.28.11	2.8mm
902.001.35.12	902.001.35.11	3.5mm
902.001.58.12	902.001.58.11	5.8mm
902.001.60.12	902.001.60.11	6.0mm
902.001.70.12	902.001.70.11	7.0mm
902.001.75.12	902.001.75.11	7.5mm
902.001.80.12	902.001.80.11	8.0mm
902.001.90.12	902.001.90.11	9.0mm
902.001.98.12	902.001.98.11	9.8mm
902.001.100.12	902.001.100.11	10.0mm
902.001.118.12	902.001.118.11	11.8mm
902.001.130.12	902.001.130.11	13.0mm
902.001.133.12	902.001.133.11	13.3mm
902.001.150.12	902.001.150.11	15.0mm
902.001.160.12	902.001.160.11	16.0mm

Refills - **\$2.75 ea**

3@ \$2.50ea

Seiko Type Clasp - Double Slot for use with a Screw 903.001



Assortment includes one each yellow and white 2.3, 3.0, 4.0 and 5.0mm, 8 total.

903.001 Assortment \$15.95

White	Yellow	Size
903.001.23.12	903.001.23.11	2.3mm
903.001.30.12	903.001.30.11	3.0mm
903.001.40.12	903.001.40.11	4.0mm
903.001.50.12	903.001.50.11	5.0mm

Additional sizes available:

White	Yellow	Size
903.001.28.12	903.001.28.11	2.8mm
903.001.35.12	903.001.35.11	3.5mm
903.001.45.12	903.001.45.11	4.5mm
903.001.55.12	903.001.55.11	5.5mm
903.001.60.12	903.001.60.11	6.0mm
903.001.65.12	903.001.65.11	6.5mm
903.001.70.12	903.001.70.11	7.0mm
903.001.75.12	903.001.75.11	7.5mm
903.001.80.12	903.001.80.11	8.0mm
903.001.85.12	903.001.85.11	8.5mm
903.001.90.12	903.001.90.11	9.0mm
903.001.95.12	903.001.95.11	9.5mm
903.001.100.12	903.001.100.11	10.0mm
903.001.105.12	903.001.105.11	10.5mm
903.001.110.12	903.001.110.11	11.0mm
903.001.115.12	903.001.115.11	11.5mm
903.001.120.12	903.001.120.11	12.0mm
903.001.130.12	903.001.130.11	13.0mm
903.001.140.12	903.001.140.11	14.0mm
903.001.150.12	903.001.150.11	15.0mm
903.001.160.12	903.001.160.11	16.0mm

Refills

\$2.75ea 3@ \$2.50ea

Seiko Type Clasp for use without a Screw 904.001



Assortment of 12 link band center foldover clasps to fit Armitron, Bulova, Elgin, Casio and other ladies' watches. Contains 2 each yellow and 1 each white sizes.

904.001 Assortment \$21.95

White	Yellow	Size
904.001.30.12	904.001.30.11	3.0mm
904.001.40.12	904.001.40.11	4.0mm
904.001.50.12	904.001.50.11	5.0mm
904.001.60.12	904.001.60.11	6.0mm

Additional sizes available:

White	Yellow	Size
904.001.20.12	904.001.20.11	2.0mm
904.001.70.12	904.001.70.11	7.0mm
904.001.80.12	904.001.80.11	8.0mm
904.001.90.12	904.001.90.11	9.0mm
904.001.100.12	904.001.100.11	10.0mm
904.001.110.12	904.001.110.11	11.0mm
904.001.120.12	904.001.120.11	12.0mm
904.001.130.12	904.001.130.11	13.0mm
904.001.140.12	904.001.140.11	14.0mm
904.001.150.12	904.001.150.11	15.0mm
904.001.160.12	904.001.160.11	16.0mm

Refills -

\$2.75 ea

3@ \$2.50ea

BUCKLE & STRAP KEEPER ASSORTMENTS

Buckle for Strap Plated

900.066-067



60 watch strap buckles - Choose 30 each yellow and white, or 60 all white.

900.066 Yellow & White Asst \$17.95
900.067 All White Asst \$17.95

Yellow	White	Size
900.066.08Y	900.066.08W	8.0mm
900.066.10Y	900.066.10W	10.0mm
900.066.11Y	900.066.11W	11.0mm
900.066.13Y	900.066.13W	13.0mm
900.066.14Y	900.066.14W	14.0mm
900.066.16Y	900.066.16W	16.0mm
900.066.18Y	900.066.18W	18.0mm

Refills- \$3.50/pack 3pks@\$3.25 pk
6pks@\$3.00 pk

Buckle for Strap Stainless Steel

900.069



Heavy, solid, high quality, highly polished. Two each size 8, 12 and 18mm, and 4 each 10, 14 and 16mm, 18 total.

900.069 Assortment-White \$26.95
900.069Y Assortment-Yellow \$26.95

White	Yellow	Size
900.069.08	900.069.08Y	8mm
900.069.10	900.069.10Y	10mm
900.069.12	900.069.12Y	12mm
900.069.14	900.069.14Y	14mm
900.069.16	900.069.16Y	16mm
900.069.18	900.069.18Y	18mm
900.069.20	900.069.20Y	20mm
900.069.22	900.069.22Y	22mm
900.069.24	900.069.24Y	24mm

Additional sizes available:

900.069.26	900.069.26Y	26mm
900.069.28	900.069.28Y	28mm
900.069.30	900.069.30Y	30mm

Refills- \$3.00ea 3@\$2.75ea
6@\$2.50ea 12@\$2.25ea

Leather Strap Keepers

680.051-52



Assortment of 20 pieces (5 each of sizes 10, 12, 18 and 20mm) in black or brown.

680.051 Black Assortment \$9.95
680.052 Brown Assortment \$9.95

Double Press Butterfly Deployment Buckle for Leather Strap

906.012



White stainless steel or yellow plated stainless steel sold individually, or as all white assortment including 1 each of 6 sizes.

906.012 Assortment \$52.95

White	Yellow	Size
906.012.12	906.012.12Y	12mm
906.012.14	906.012.14Y	14mm
906.012.16	906.012.16Y	16mm
906.012.18	906.012.18Y	18mm
906.012.20	906.012.20Y	20mm
906.012.22	906.012.22Y	22mm

White Refills - \$11.95ea
Yellow Refills - \$12.95ea

Deployment Buckle for Strap

980.311



Stainless Steel assortment of 6, 1 each Yellow and White buckles in sizes 14, 16, and 18mm.

980.311 Assortment \$46.95

White	Yellow	Size
980.311.14W	980.311.14Y	14.0mm
980.311.16W	980.311.16Y	16.0mm
980.311.18W	980.311.18Y	18.0mm

Additional sizes available:

White	Yellow	Size
980.311.12W	980.311.12Y	12.0mm
980.311.20W	980.311.20Y	20.0mm
980.311.22W		22.0mm
980.311.24W		24.0mm

Yellow Refills \$9.95ea
White Refills 14mm-20mm \$8.95ea
White Refills 22mm-24mm \$12.95ea

Foldover Clasp for Cord Band

980.310

Yellow or white plated. Sold individually.

980.310.11 Yellow \$3.25ea

980.310.12 White \$3.25ea

380.125 Black cord \$4.95/foot



PVC Strap Keepers

680.095



25 pieces, 5 each of 16, 18, 20, 22, 24mm. Black. Refills contain 10 pieces per size.

680.095 Assortment \$9.95

680.095.16	16mm
680.095.18	18mm
680.095.20	20mm
680.095.22	22mm
680.095.24	24mm

Refills- \$5.95

Additional sizes available:

680.095.26	26mm
680.095.28	28mm
680.095.30	30mm

Refills- \$6.95

METAL CLASP ASSORTMENTS

Sliding Clasp 900.088

Assortment includes 2 top clasps each size, white & yellow, and 1 slide clasp of each size. 32 pieces, sizes to fit band thickness' 1.75, 1.85, 1.95 & 2.05mm.

900.088 Assortment **\$28.95**



White	Yellow	Style	Size	Price
900.088.07.TW	900.088.07.TY	Top	7mm	\$2.25
900.088.08.TW	900.088.08.TY	Top	8mm	\$2.25
900.088.10.TW	900.088.10.TY	Top	10mm	\$2.25
900.088.15.TW	900.088.15.TY	Top	15mm	\$2.25
900.088.07.175		Slide	7 x 1.75mm	\$1.95
900.088.07.185		Slide	7 x 1.85mm	\$1.95
900.088.07.195		Slide	7 x 1.95mm	\$1.95
900.088.07.205		Slide	7 x 2.05mm	\$1.95
900.088.08.175		Slide	8 x 1.75mm	\$1.95
900.088.08.185		Slide	8 x 1.85mm	\$1.95
900.088.08.195		Slide	8 x 1.95mm	\$1.95
900.088.08.205		Slide	8 x 2.05mm	\$1.95
900.088.10.175		Slide	10 x 1.75mm	\$1.95
900.088.10.185		Slide	10 x 1.85mm	\$1.95
900.088.10.195		Slide	10 x 1.95mm	\$1.95
900.088.10.205		Slide	10 x 2.05mm	\$1.95
900.088.15.175		Slide	15 x 1.75mm	\$1.95
900.088.15.185		Slide	15 x 1.85mm	\$1.95
900.088.15.195		Slide	15 x 1.95mm	\$1.95
900.088.15.205		Slide	15 x 2.05mm	\$1.95

Mushroom Pins for Buckles 906.054

60 pieces, 5 each of 12 sizes. No Refills.
906.054 Assortment **\$24.95**



Mushroom Pins for Buckles 906.054

12 SIZES @ 5PCS, TOTAL 60 PCS. No Refills

No. 01	No. 02	No. 03	No. 04	No. 05	No. 06
A 2.40	A 2.00	A 2.00	A 2.20	A 1.80	A 2.30
B 1.48	B 1.50	B 1.20	B 1.50	B 1.00	B 1.50
C 0.95	C 2.50	C 2.00	C 2.20	C 2.50	C 2.50
D 0.95	D 1.10	D 1.20	D 1.23	D 1.25	D 1.25
E 5.00	E 5.00	E 2.20	E 4.60	E 4.90	E 5.10

No. 07	No. 08	No. 09	No. 10	No. 11	No. 12
A 2.50	A 2.10	A 2.20	A 2.50	A 2.20	A 2.00
B 1.50	B 1.20	B 1.30	B 1.45	B 1.15	B 1.20
C 2.50	C 2.50	C 2.50	C 2.50	C 2.50	C 2.50
D 1.25	D 1.30	D 1.30	D 1.30	D 1.35	D 1.40
E 4.80	E 5.10	E 5.20	E 5.40	E 4.70	E 4.20

MUSHROOM PIN

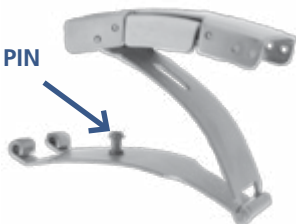

Tri-Fold Double Push Button Clasp 900.280

Stainless steel secure locking clasps require both sides be pushed to open. Replaces Seiko, Bulova and others. Assortment of 8 includes 1 each yellow and white of *sizes 12-18 below.

900.280 Asst-Yellow & White **\$23.95**



mm size = outside width

900.280.10Y	Yellow	10mm
* 900.280.12Y	Yellow	12mm
* 900.280.14Y	Yellow	14mm
* 900.280.16Y	Yellow	16mm
* 900.280.18Y	Yellow	18mm
900.280.20Y	Yellow	20mm
900.280.22Y	Yellow	22mm
900.280.24Y	Yellow	24mm
900.280.26Y	Yellow	26mm
Refills-	\$4.50ea	3@ \$4.25ea
900.280.10	White	10mm
* 900.280.12	White	12mm
* 900.280.14	White	14mm
* 900.280.16	White	16mm
* 900.280.18	White	18mm
900.280.20	White	20mm
900.280.22	White	22mm
900.280.24	White	24mm
900.280.26	White	26mm
Refills-	\$3.95ea	3@ \$3.75ea

Tri-Fold Double Push Button Clasp 900.280B

Assortment of 9 black clasps, 1 each sizes 10-26mm.

900.280B Assortment-Black **\$29.95**



mm size = outside width

900.280.10B	Black	10mm
900.280.12B	Black	12mm
900.280.14B	Black	14mm
900.280.16B	Black	16mm
900.280.18B	Black	18mm
900.280.20B	Black	20mm
900.280.22B	Black	22mm
900.280.24B	Black	24mm
900.280.26B	Black	26mm
Refills -	\$3.95ea	3@ \$3.75ea

Tri-Fold Double Push Button Clasp 900.280R

Assortment of 9 rose gold clasps, 1 each sizes 10-26mm.

900.280R Asst-Rose Gold **\$29.95**



mm size = outside width

900.280.10R	Rose	10mm
900.280.12R	Rose	12mm
900.280.14R	Rose	14mm
900.280.16R	Rose	16mm
900.280.18R	Rose	18mm
900.280.20R	Rose	20mm
900.280.22R	Rose	22mm
900.280.24R	Rose	24mm
900.280.26R	Rose	26mm
Refills -	\$3.95ea	3@ \$3.75ea

Longines Style Clasp 980.145

White double foldover 14.5mm. Sold individually.

980.145 **\$3.25ea**



Tri-Fold Clasp 900.400



Assortment of all white adjustable clasps with an extra security foldover. 12 piece assortment has two each size all white stainless steel.

900.400 Assortment		\$32.95
900.400.10	White	10mm
900.400.12	White	12mm
900.400.14	White	14mm
900.400.16	White	16mm
900.400.18	White	18mm
900.400.20	White	20mm

Yellow Plated Stainless available individually (not in assortment).

900.400.10G	Yellow	10mm
900.400.12G	Yellow	12mm
900.400.14G	Yellow	14mm
900.400.16G	Yellow	16mm
900.400.18G	Yellow	18mm
900.400.20G	Yellow	20mm

Refills **\$3.95ea 3@ \$3.75ea 6@ \$3.50ea**

RADO Style Spring Loaded Clasps 906.011



mm sizes = outside width & opening width

Stainless steel clasps feature a spring loaded extension that expands the clasp for easy on and off the wrist. Includes one each of 8 sizes.

906.011 Assortment		\$23.95
Number	Width	Opening
906.011.12.07	12mm	7mm
906.011.14.07	14mm	7mm
906.011.16.08	16mm	8mm
906.011.16.10	16mm	10mm
906.011.18.08	18mm	8mm
906.011.18.10	18mm	10mm
906.011.20.10	20mm	10mm
906.011.20.12	20mm	12mm

Refills- **\$3.95ea 3@ \$3.75ea**

Trifold Titanium Clasp 906.039



mm size = outside width

Titanium secure locking clasps require both sides be pushed to open. Assortment includes 1 each of 7 sizes.

906.039 Assortment		\$39.95
906.039.10		10mm
906.039.12		12mm
906.039.14		14mm
906.036.16		16mm
906.039.18		18mm
906.039.20		20mm
906.039.22		22mm

Refills- **\$6.95ea 3@ \$6.50ea**

Tri-Fold Buckle with Extender 980.270-273



mm size = inside width

Adjustable extender lengthens a watch bracelet. Stainless steel. Sold individually.

980.270Y	Yellow	10mm
980.273Y	Yellow	16mm

\$7.95 ea

Tri-Fold Black Clasp 900.400B



Assortment of 7 adjustable black clasps with extra security foldover, 10mm.

900.400B Assortment-Black		\$25.95
900.400.12B	12mm	
900.400.14B	14mm	
900.400.16B	16mm	
900.400.18B	18mm	
900.400.20B	20mm	
900.400.22.10B	22-10mm	
900.400.22.12B	22-12mm	

Refills **\$4.95ea 3@ \$4.75ea 6@ \$4.50ea**

Citizen Style Foldover Clasp 999.131



mm size = inside width

Stainless steel twelve-piece assortment has two each size.

999.131 Assortment		\$26.95
999.131.10	White	10mm
999.131.12	White	12mm
999.131.14	White	14mm
999.131.16	White	16mm
999.131.18	White	18mm
999.131.20	White	20mm

Refills -

\$3.25ea

Citizen Style Slide Lock 999.132



Stainless steel ten-piece assortment has one each white and yellow sizes: 10, 12, 14, 16, and 18mm.

999.132 Assortment		\$27.95
White	Yellow	Size
999.132.10W	999.132.10Y	10mm
999.132.12W	999.132.12Y	12mm
999.132.14W	999.132.14Y	14mm
999.132.16W	999.132.16Y	16mm
999.132.18W	999.132.18Y	18mm

Refills -

\$3.75 ea

Single Push Button Clasp 980.329.12-24



mm size = inside width

Stainless steel with a single button on one side for easy release. Sold individually.

980.329.12	White	12mm
980.329.14	White	14mm
980.329.16	White	16mm
980.329.18	White	18mm
980.329.20	White	20mm
980.329.22	White	22mm
980.329.24	White	24mm

\$3.95ea 3@ \$3.75ea

Double Push Button Clasp with Safety 999.128



mm size = inside width

Fossil style ten piece assortment includes two each sizes 12-20, all white stainless.























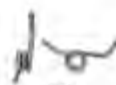
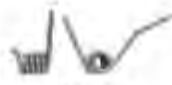





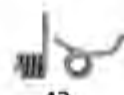
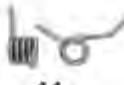



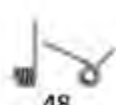

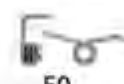









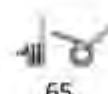

999.128 Assortment		\$34.95
999.128.12	White	12mm
999.128.14	White	14mm
999.128.16	White	16mm
999.128.18	White	18mm
999.128.20	White	20mm

Also available:

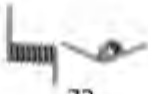
999.128.22	White	22mm
999.128.24	White	24mm

Refills **\$5.25ea 3@ \$4.75ea 6@ \$4.50ea**

BRACELET SPRINGS

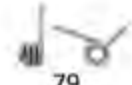
 20 820.5463.20	 21 820.5463.21	22 discontinued	 23 820.5463.23	24 discontinued	 25 820.5463.25	 26 820.5463.26
 27 820.5463.27	 28 820.5463.28	 29 820.5463.29	 30 820.5463.30	31 discontinued	 32 820.5463.32	 33 820.5463.33
 34 820.5463.34	 35 820.5463.35	 36 820.5463.36	 37 820.5463.37	 38 820.5463.38	 39 820.5463.39	 40 820.5463.40
 41 820.5463.41	 42 Limited Supply 820.5463.42	 43 820.5463.43	 44 820.5463.44	 45 820.5463.45	 46 820.5463.46	 47 820.5463.47
 48 820.5463.48	 49 820.5463.49	 50 820.5464.50	 51 820.5464.51	 52 820.5464.52	 53 820.5464.53	 54 820.5464.54
 55 820.5464.55	56 discontinued	 57 820.5464.57	 58 820.5464.58	 59 820.5464.59	 60 820.5464.60	 61 820.5464.61
 62 820.5464.62	 63 820.5464.63	64 discontinued	 65 820.5464.65	 66 820.5464.66	67 discontinued	68 discontinued
 69 820.5464.69	 70 820.5464.70	 71 820.5464.71	 72 820.5464.72	 73 820.5464.73	 74 820.5464.74	 75 820.5464.75
 76 820.5464.76	 77 820.5464.77	 78 820.5464.78	 79 820.5464.79			

BERGEON Bracelet Springs

Individual genuine Bergeon springs from discontinued assortments 820.5463 & 820.5464 for watch and jewelry bracelets.

Assortment **820.5463** Refill Numbers 20 thru 49
Assortment **820.5464** Refill Numbers 50 thru 79
\$3.95 ea

0.80mm Bracelet Cotter Pin 900.080

Four each of eighteen sizes (72 pcs) 0.80mm diameter stainless steel pins for attaching links to watch bands.

900.080 Assortment	\$16.95	
900.080.05 5mm	900.080.14 14mm	
900.080.06 6mm	900.080.15 15mm	
900.080.07 7mm	900.080.16 16mm	
900.080.08 8mm	900.080.17 17mm	
900.080.09 9mm	900.080.18 18mm	
900.080.10 10mm	900.080.19 19mm	
900.080.11 11mm	900.080.20 20mm	
900.080.12 12mm	900.080.21 21mm	
900.080.13 13mm	900.080.22 22mm	
Refills	\$3.25/pack of 12	



1.20mm Bracelet Cotter Pin 900.129

Six each of eleven sizes (66 total) 1.20mm diameter stainless steel pins for attaching links to watch bands.

900.129 Assortment	\$16.95	
900.129.20 20mm	900.129.26 26mm	
900.129.21 21mm	900.129.27 27mm	
900.129.22 22mm	900.129.28 28mm	
900.129.23 23mm	900.129.29 29mm	
900.129.24 24mm	900.129.30 30mm	
900.129.25 25mm		



Additional sizes available:

900.129.12 12mm	900.129.17 17mm
900.129.14 14mm	900.129.18 18mm
900.129.15 15mm	900.129.19 19mm
900.129.16 16mm	

Order Refills by Number **\$3.25/pk of 12**

0.90 & 1.00mm Bracelet Cotter Pin 900.096

Five each of 24 sizes (120 pcs) steel pins for attaching links to watch bands. 2 thicknesses.

900.096 Assortment	\$23.95	
0.90 Diam. Length	1.00 Diam. Length	
900.096.01 5mm	900.096.13 5.5mm	
900.096.02 6mm	900.096.14 6.5mm	
900.096.03 7mm	900.096.15 7mm	
900.096.04 8mm	900.096.16 8mm	
900.096.05 9mm	900.096.17 9mm	
900.096.06 10mm	900.096.18 11mm	
900.096.07 11mm	900.096.19 12mm	
900.096.08 12mm	900.096.20 13mm	
900.096.09 13mm	900.096.21 14mm	
900.096.10 14mm	900.096.22 16mm	
900.096.11 16mm	900.096.23 18mm	
900.096.12 18mm	900.096.24 19mm	



Also available:

900.096.37 4mm, 0.90mm diameter
Refills \$3.25/pack of 12

1.10mm Pressure Pin for TriFold Clasp 900.010

End pieces friction fit into tubes. 1.10mm diameters. Ten each of 7 sizes:

900.010 Assortment	\$23.95	
900.010.10 10mm	900.010.18 18mm	
900.010.12 12mm	900.010.20 20mm	
900.010.14 14mm	900.010.22 22mm	
900.010.16 16mm		



Additional Size not in Assortment:

900.010.24 24mm

Refills **\$4.75/pack of 10**

0.90, 1.00, 1.10, 1.20mm Pressure Pins 901.025,027,028,031

Steel knurled pins for band links, 360 total, 20 each of 18 lengths. 4 diameters.

901.027 0.90mm Assortment	\$24.95
901.025 1.00mm Assortment	\$24.95
901.031 1.10mm Assortment	\$24.95
901.028 1.20mm Assortment	\$24.95



0.90mm	1.00mm	1.10mm	1.20mm	Lgth
901.027.07	901.025.07	901.031.07	901.028.07	7.0
901.027.08	901.025.08	901.031.08	901.028.08	8.0
901.027.09	901.025.09	901.031.09	901.028.09	9.0
901.027.10	901.025.10	901.031.10	901.028.10	10.0
901.027.11	901.025.11	901.031.11	901.028.11	11.0
901.027.12	901.025.12	901.031.12	901.028.12	12.0
901.027.13	901.025.13	901.031.13	901.028.13	13.0
901.027.14	901.025.14	901.031.14	901.028.14	14.0
901.027.15	901.025.15	901.031.15	901.028.15	15.0
901.027.16	901.025.16	901.031.16	901.028.16	16.0
901.027.17	901.025.17	901.031.17	901.028.17	17.0
901.027.18	901.025.18	901.031.18	901.028.18	18.0
901.027.19	901.025.19	901.031.19	901.028.19	19.0
901.027.20	901.025.20	901.031.20	901.028.20	20.0
901.027.21	901.025.21	901.031.21	901.028.21	21.0
901.027.22	901.027.22	901.031.22	901.028.22	22.0
901.027.23	901.025.23	901.031.23	901.028.23	23.0
901.027.24	901.025.24	901.031.24	901.028.24	24.0

Additional Size not in assortment:
901.025.25 20.5

Refills **\$3.25 dz**

0.90 & 1.00mm Long Cotter Pin 900.096L

6 each of 12 sizes (72 pcs) Steel Pins for attaching links to watch bands. 2 thicknesses.

900.096L Assortment	\$19.95	
0.90 Diam. Length	1.00 Diam. Length	
900.096.25 20mm	900.096.26 20mm	
900.096.27 22mm	900.096.28 22mm	
900.096.29 24mm	900.096.30 24mm	
900.096.31 26mm	900.096.32 26mm	
900.096.33 28mm	900.096.34 28mm	
900.096.35 30mm	900.096.36 30mm	
Refills	\$3.25/pack of 12	



BRACELET PIN ASSORTMENTS

Long Pressure Pins 999.020

1.20mm diameters., 2.0mm heads.
48 pieces total, 6 each of 8 lengths.

999.020 Assortment \$23.95

999.020.18 18mm **999.020.26** 26mm
999.020.20 20mm **999.020.28** 28mm
999.020.22 22mm **999.020.30** 30mm
999.020.24 24mm **999.020.32** 32mm

Refills **\$5.50 dozen**



1.20mm Pressure Pin 999.120

End pieces friction fit into tubes. 1.20mm diameters. 10 each of seven sizes:

999.120 1.20mm Assortment \$23.95

999.120.10 10mm **999.120.18** 18mm
999.120.12 12mm **999.120.20** 20mm
999.120.14 14mm **999.120.22** 22mm
999.120.16 16mm

Refills **\$4.75/pack of 10**



Notched Pin with Notched Tube 900.638

Notched bracelet pins 0.90mm diameter with notched tubes 1.20mm diameter. Five each 12 lengths, 60 pieces total.

900.638 Assortment \$23.95

900.638.10 10mm **900.638.16** 16mm
900.638.11 11mm **900.638.17** 17mm
900.638.12 12mm **900.638.18** 18mm
900.638.13 13mm **900.638.19** 19mm
900.638.14 14mm **900.638.20** 20mm
900.638.15 15mm **900.638.21** 21mm

Refills in packs of 10 pair of one number
 Refills **\$5.00/pack of 10pk**



Bracelet Pin 932.035

60 Swiss straight stainless steel bracelet pins in ten diameter sizes, 30mm long.

932.035 Bracelet Pins \$34.95

932.035.01 0.80mm
932.035.02 0.90mm
932.035.03 1.00mm
932.035.04 1.10mm
932.035.05 1.20mm
932.035.06 1.30mm
932.035.07 1.40mm
932.035.08 1.50mm
932.035.09 1.60mm
932.035.10 1.80mm

Refills - **\$1.75 ea**
3@\$1.50ea 6@\$1.40ea 12@\$1.30ea



Watch Band Pressure Pins 999.130

Steel knurled pressure pins for band links. 5 of 11 sizes; 55 pieces total. 1.30mm diameters, 1.8mm heads.

999.130 Assortment \$23.95

999.130.10 10mm **999.130.22** 22mm
999.130.12 12mm **999.130.24** 24mm
999.130.14 14mm **999.130.26** 26mm
999.130.16 16mm **999.130.28** 28mm
999.130.18 18mm **999.130.30** 30mm
999.130.20 20mm

Refills **\$4.75/pack of 10**



Watch Band Pressure Pins 999.150

Steel knurled 1.5mm diam. pressure pins for band links. 5 of 11 sizes; 55 pieces total.

999.150 Assortment \$23.95

999.150.10 10mm **999.150.20** 20mm
999.150.12 12mm **999.150.22** 22mm
999.150.14 14mm **999.150.24** 24mm
999.150.16 16mm **999.150.26** 26mm
999.150.18 18mm **999.150.28** 28mm
999.150.30 30mm

Refills **\$4.75/pack of 10**



Bracelet Pin 932.065

60 (5 each size) friction style straight Stainless Steel pins, 27mm long. Swiss made, stamped to be thicker on one end with weak (light) and strong (deep) stamp diameters available.

932.065 Assortment \$42.95

Light Stamp

932.065.01 0.8 x 0.9mm **932.065.06** 0.8 x 0.9mm
932.065.02 0.9 x 1.0mm **932.065.07** 0.9 x 1.06mm
932.065.03 1.0 x 1.1mm **932.065.08** 1.0 x 1.2mm
932.065.04 1.1 x 1.2mm **932.065.09** 1.1 x 1.3mm
932.065.05 1.2 x 1.3mm **932.065.10** 1.2 x 1.4mm

Deep Stamp

Refills - **\$1.75 ea**
3@\$1.50 ea 6@\$1.40 ea 12@\$1.30ea



Bracelet Pin & Tube 956.065

Bracelet Pin & Tube

5 each (70 total) Swiss made friction fit watch bracelet tubes and pins. Tubes are 12mm long and pins are 30mm long.

956.065 Assortment \$49.95

Tubes	Diam.	Pins	Diam.
956.065.01	1.0mm	956.065.09	.70mm
956.065.02	1.1mm	956.065.10	.80mm
956.065.03	1.2mm	956.065.11	.90mm
956.065.04	1.3mm	956.065.12	1.0mm
956.065.05	1.4mm	956.065.13	1.0mm
956.065.06	1.5mm	956.065.14	1.1mm
956.065.07	1.8mm	956.065.15	1.4mm

Refills - **\$1.75 ea**
3@\$1.50ea 6@\$1.40ea 12@\$1.30ea



BRACELET LUG & T-BAR ASSORTMENTS

Bracelet Screw Lug 900.072, 077



84 (12 each size) white or yellow lugs and screws for notched bands.

900.072 White Assortment **\$36.95**
900.077 Yellow Assortment **\$36.95**

White	Yellow	
900.072.08	900.077.08	8mm
900.072.10	900.077.10	10mm
900.072.12	900.077.12	12mm
900.072.14	900.077.14	14mm
900.072.16	900.077.16	16mm
900.072.18	900.077.18	18mm
900.072.20	900.077.20	20mm
<i>Additional Sizes not in Assortment:</i>		
900.072.22	900.077.22	22mm
900.072.24	900.077.24	24mm
(\$2.00 set, no break)		
900.072.26	900.077.26	26mm
(\$2.00 set, no break)		
900.072.28	900.077.28	28mm
(\$2.00 set, no break)		
Refills - \$2.25/set		
3@\$2.00 6@\$1.75 12@\$1.50		

Gucci Style Threaded Bar & Screw 902.540



GREAT DEAL!
\$150.00 if purchased separately

Twelve white & twelve yellow 1.8mm head screws and 12 white & 12 yellow 2.2mm head screws (48 screws), with two each of 12 lengths threaded 1.20mm bars (24 bars).

902.540 Assortment **\$109.95**

Bar	Length	Screws	Head Diam.
902.540.01	10mm	Yellow	1.80mm
902.540.02	11mm	902.540.151	1.80mm
902.540.03	12mm	902.540.162	2.0mm
902.540.04	13mm	White	1.80mm
902.540.05	14mm	902.540.171	1.80mm
902.540.06	15mm	902.540.182	2.0mm
902.540.07	16mm		
902.540.08	17mm		
902.540.09	18mm		
902.540.10	19mm		
902.540.11	20mm		
902.540.12	22mm		
Refills, Bars -		\$2.75 ea	
Refills, Screws -		\$4.50 pr	

T-Bars 906.037



No refills.

Stainless steel T-Bar assortment contains four sets of ten different sizes, all 30mm long. Size is head diameter x tube diameter.

906.037 Assortment **\$34.95**

1.5 x 1.0	2.5 x 1.3
1.5 x 1.1	2.0 x 1.5
1.6 x 1.2	2.5 x 1.5
1.8 x 1.3	3.0 x 1.5

Large T-Bars 906.038



No refills.

Stainless Steel T-Bar assortment contains four sets of ten different sizes. Size is head diameter x tube diameter x tube length.

906.038 Assortment **\$34.95**

2.5 x 1.8 x 30	5.0 x 1.8 x 36
3.0 x 1.8 x 30	4.0 x 2.0 x 36
3.5 x 1.8 x 30	4.5 x 2.0 x 36
4.0 x 1.8 x 36	5.0 x 2.0 x 36
4.5 x 1.8 x 36	5.0 x 2.2 x 36



Watch Lug Gauge

A simple, easy to use stainless steel tool for measuring watch lug widths 6mm to 22mm. Includes slots for measuring strap and bracelet ends.

350.159 \$14.25

BAND END, CONNECTOR LINK ASSORTMENTS

Band End Pieces 900.629

Assortment of 72, two each of 36 types. Includes pointed 2 cut, rounded, and straight styles in assorted white, tutone and yellow. Sizes included: 13, 14, 18, 19, 20 and 22mm.

900.629 Assortment \$38.95

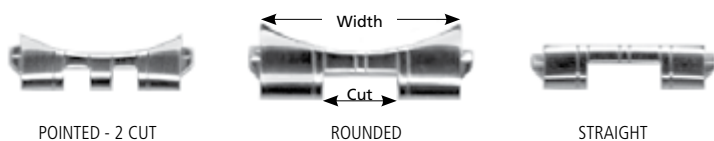

POINTED TYPE

TuTone	White	Yellow	Width	Cut
900.629.PT-13-6	900.629.PW-13-6	900.629.PY-13-6	13mm	6mm
900.629.PT-14-6	PW-14-6		14mm	6mm
	PW-14-7		14mm	7mm
900.629.PT-14-2C	900.629.PW-14-2C		14mm	2cuts
	900.629.PW-18-7		18mm	7mm
		900.629.PY-18-8	18mm	8mm
	900.629.PW-18-9		18mm	9mm
	900.629.PW-18-10		18mm	10mm
900.629.PT-18-2C	900.629.PW-18-2C		18mm	2cuts
	900.629.PW-19-7		19mm	7mm
900.629.PT-19-8		900.629.PY-19-8	19mm	8mm
	900.629.PW-20-8	900.629.PY-20-8	20mm	8mm
	900.629.PW-20-9		20mm	9mm
	900.629.PW-20-10		20mm	10mm
900.629.PT-20-2C	900.629.PW-20-2C	900.629.PY-20-2C	20mm	2cuts
900.629.PT-22-8	900.629.PW-22-8		22mm	8mm

ROUNDED TYPE

TuTone	White	Width	Cut
	900.629.RW-14-5	14mm	5mm
900.629.RT-18-8	900.629.RW-18-8	18mm	8mm
900.629.RT-19-8	900.629.RW-19-8	19mm	8mm
900.629.RT-20-8		20mm	8mm

STRAIGHT TYPE

TuTone	White	Width	Cut
900.629.ST-18-8	900.629.SW-18-8	18mm	8mm
	900.629.SW-20-8	20mm	8mm

Refills sold in pairs only - .

\$2.95/pair

Bracelet Connector Links to fit RLX 999.659

Assortment contains 8 different generic links to fit RLX bracelets; 4 each for Jubilee and Oyster models, both opening and other sides.

999.659 Assortment \$46.95

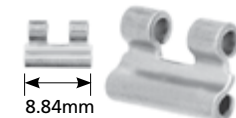

999.659.01
Opening Side

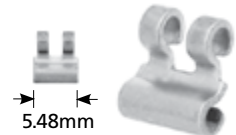

999.659.02
Opening Side

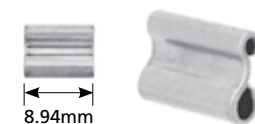

999.659.03
Opening Side

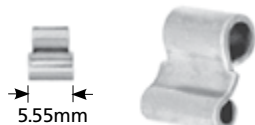

999.659.04
Opening Side

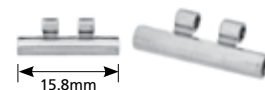

999.659.05
Other Side

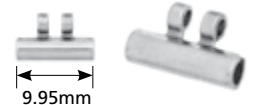

999.659.06
Other Side

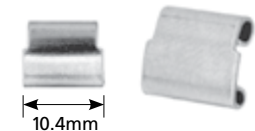

999.659.07
Other Side

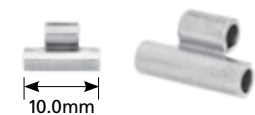

999.659.08
Other Side

Cas-Ker Co. is independent of and is not affiliated with or sponsored by Rolex Watch U.S.A. Inc. The Rolex warranty does not apply to non-genuine replacement items supplied by Cas-Ker Co.

Cas-Ker carries a wide selection of genuine & generic RLX parts. Visit casker.com or request our RLX Catalog 900.105 for more!



Stainless Steel Bracelet to fit Ladies' Jubilee 13mm. 680.071 Call for price.



Stainless Steel Bracelet to fit Men's Jubilee 20mm. 680.072 Call for price.



Stainless Steel Bracelet to fit Ladies' Oyster 13mm. 680.073 Call for price.



Stainless Steel Bracelet to fit Men's Oyster w/ extension 20mm. 680.075 Call for price.

SPRING BAR ASSORTMENTS - DOUBLE FLANGE

1.00mm Ultra-Thin Double Flange Spring Bar 901.120

Stainless Steel. 1.00mm thin. 360 pieces total, 20 each of 18 sizes.

901.120 Assortment	\$34.95
901.120.05 5mm	901.120.14 14mm
901.120.06 6mm	901.120.15 15mm
901.120.07 7mm	901.120.16 16mm
901.120.08 8mm	901.120.17 17mm
901.120.09 9mm	901.120.18 18mm
901.120.10 10mm	901.120.19 19mm
901.120.11 11mm	901.120.20 20mm
901.120.12 12mm	901.120.21 21mm
901.120.13 13mm	901.120.22 22mm

Refills - **\$4.20 dz**

1.50mm Thin Double Flange Spring Bar 900.086

216 (12 each size) Thin Stainless Steel Spring Bars. 1.50mm diameter.

900.086 Assortment	\$24.95
900.086.07 7mm	900.086.16 16mm
900.086.08 8mm	900.086.17 17mm
900.086.09 9mm	900.086.18 18mm
900.086.10 10mm	900.086.19 19mm
900.086.11 11mm	900.086.20 20mm
900.086.12 12mm	900.086.21 21mm
900.086.13 13mm	900.086.22 22mm
900.086.14 14mm	900.086.24 24mm
900.086.15 15mm	

Refills **\$4.20 dz \$10.00/100 of a size**

1.20mm X-Thin Double Flange Spring Bar 900.220

360 Extra-Thin stainless steel spring bars for thin clasps. 20 each of 18 sizes, 1.20mm diameter.

900.220 Assortment	\$34.95
900.220.07 7mm	900.220.16 16mm
900.220.08 8mm	900.220.17 17mm
900.220.09 9mm	900.220.18 18mm
900.220.10 10mm	900.220.19 19mm
900.220.11 11mm	900.220.20 20mm
900.220.12 12mm	900.220.21 21mm
900.220.13 13mm	900.220.22 22mm
900.220.14 14mm	900.220.23 23mm
900.220.15 15mm	900.220.24 24mm

Refills **\$4.20 dz \$10.00/100 of a size**

1.50mm Extra Long Double Flange Spring Bar 24-30mm 900.925

Stainless 24 each of 7 sizes, 168 total.

900.925 Assortment	\$21.95
900.925.24 24mm	900.925.28 28mm
900.925.25 25mm	900.925.29 29mm
900.925.26 26mm	900.925.30 30mm
900.925.27 27mm	

Refills **\$4.20 dz \$10.00/100 of a size**

1.50mm XXLong Double Flange Spring Bar 32-40mm 900.925L

Stainless 6 each of 5 sizes, 30 total.

900.925L Assortment	\$16.95
900.925.32 32mm	900.925.38 38mm
900.925.34 34mm	900.925.40 40mm
900.925.36 36mm	

Refills **\$7.50 dozen of a size**

1.30mm Thin Double Flange Spring Bar 900.085

216 total, 12 each size thin stainless steel spring bars. 1.30mm diameter.

900.085 Assortment	\$24.95
900.085.06 6mm	900.085.15 15mm
900.085.07 7mm	900.085.16 16mm
900.085.08 8mm	900.085.17 17mm
900.085.09 9mm	900.085.18 18mm
900.085.10 10mm	900.085.19 19mm
900.085.11 11mm	900.085.20 20mm
900.085.12 12mm	900.085.21 21mm
900.085.13 13mm	900.085.22 22mm
900.085.14 14mm	

Refills **\$4.20 dz \$10.00/100 of a size**

1.80mm Regular Double Flange Spring Bar 900.144

216 Stainless Steel Spring Bars. 1.80mm diameter. Contains 12 each (24pcs 18mm).

900.144 Assortment	\$25.95
900.144.08 8mm	900.144.17 17mm
900.144.09 9mm	900.144.18 18mm
900.144.10 10mm	900.144.19 19mm
900.144.11 11mm	900.144.20 20mm
900.144.12 12mm	900.144.21 21mm
900.144.13 13mm	900.144.22 22mm
900.144.14 14mm	900.144.23 23mm
900.144.15 15mm	900.144.24 24mm
900.144.16 16mm	

Refills **\$4.20 dz \$10.00/100 of a size**

Additional sizes not in Assortment:

900.144.26 26mm	900.144.34 34mm
900.144.28 28mm	900.144.36 36mm
900.144.30 30mm	900.144.38 38mm
900.144.32 32mm	900.144.40 40mm

Refills **\$4.20 dz \$12.50/100 of a size**

1.30mm Thin Swiss Made Double Flange Spring Bar 999.027

100 pieces, 10 each of 10 sizes stainless steel, widths 6mm thru 20mm, 1.30mm diameter.

999.027 Assortment	\$23.95
Refills-use 900.085 (see above)	\$4.20 dz \$10.00/100

(12 or 100 of one size)

Please order all assortments and refills by SKU number. Thank you!

SPRING BAR ASSORTMENTS - DOUBLE SHOULDER

1.80mm Regular Double Flange Spring Bar 999.031

100 (10 each of 10 sizes) Stainless Steel Double Flange. Widths 12mm thru 24mm. 1.80mm diameter. Swiss made.

999.031 Assortment **\$23.95**
Refills-use 900.144 (page 387) **\$4.20 dz**
\$10.00/100
(12 or 100 of one size)



2.00mm Extra Heavy Flange Spring Bar 999.126

Stainless steel, 120 total, 10 each of 12 sizes 18 - 40 mm long x 2.0 mm diameter.

999.126 Assortment **\$49.95**
999.126.18 18mm **999.126.30** 30mm
999.126.20 20mm **999.126.32** 32mm
999.126.22 22mm **999.126.34** 34mm
999.126.24 24mm **999.126.36** 36mm
999.126.26 26mm **999.126.38** 38mm
999.126.28 28mm **999.126.40** 40mm
Refills **\$10.00/dozen**



1.30mm Thin Double Shoulder & 1.78mm Regular Double Shoulder 900.099

400 pieces total, 20 each of 20 sizes.

900.099 Assortment **\$24.95**
1.30mm Thin
1/4, 5/16, 3/8, 7/16, 1/2, 9/16, 5/8,
11/16, 3/4, 13/16
Refills-use 901.016 **\$4.20 dz**
\$10.00/100

1.78mm Regular
5/16, 3/8, 7/16, 1/2, 9/16, 5/8, 11/16,
3/4, 13/16, 15/16
Refills-use 900.150 (see below) **\$7.50/100**
Please specify thickness when ordering.

1.30mm Thin Double Shoulder Spring Bar 900.200

216 piece assortment contains 12 each (24pcs 18mm) spring bars to fit Seiko, Citizen, Bulova and all other watch cases and bracelets.

900.200 Assortment **\$24.95**
900.200.06 6mm **900.200.15** 15mm
900.200.07 7mm **900.200.16** 16mm
900.200.08 8mm **900.200.17** 17mm
900.200.09 9mm **900.200.18** 18mm
900.200.10 10mm **900.200.19** 19mm
900.200.11 11mm **900.200.20** 20mm
900.200.12 12mm **900.200.21** 21mm
900.200.13 13mm **900.200.22** 22mm
900.200.14 14mm
Refills **\$4.20 dz \$10.00/100 of a size**



1.78mm Regular Double Shoulder Spring Bar 900.150

200 Spring Bars. 20 each of 10 sizes. 1.78mm diameter.

900.150 Assortment **\$21.95**
900.150.01 6mm **900.150.06** 14mm
900.150.02 8mm **900.150.07** 16mm
900.150.03 10mm **900.150.08** 18mm
900.150.04 11mm **900.150.09** 19mm
900.150.05 13mm **900.150.10** 21mm
Additional sizes not in Assortment:
900.150.11 22mm **900.150.13** 25mm
900.150.12 24mm
Refills **\$7.50/100 of a size**



1.45mm Thin Double Shoulder Spring Bar 900.140

200 Spring Bars, 20 each of 10 sizes. 1.45mm diameter. In clear compartment box.

900.140 Thin 1.45mm Asst **\$19.95**
900.140.01 6mm **900.140.06** 14mm
900.140.02 8mm **900.140.07** 16mm
900.140.03 10mm **900.140.08** 18mm
900.140.04 11mm **900.140.09** 19mm
900.140.05 13mm **900.140.10** 21mm
Additional sizes not in Assortment:
900.140.11 22mm **900.140.12** 24mm
Refills **\$7.50/100 of a size**



Curved Spring Bar 900.915

Thin Curved Double Shoulder. 72 piece assortment contains 12 each of 6 sizes.

900.915 Assortment **\$15.95**
900.915.01 13mm **900.915.04** 18mm
900.915.02 14mm **900.915.05** 19mm
900.915.03 16mm **900.915.06** 21mm
Refills **\$5.00/100 of a size**



SPRING BAR ASSORTMENTS - SHORT TIP

Spring Bar for Foldover Clasp 900.084

Digital watch spring bar tips will not protrude out of a foldover clasp. Contains 84 stainless steel spring bars, 7 ea/ 12 sizes.

900.084 Assortment \$15.95

- 900.084.01** 5/8" Center Catch
- 900.084.02** 5/8" Seiko Center Catch
- 900.084.03** 7/16" Center Catch
- 900.084.04** 5/16" Center Catch
- 900.084.05** 1/2" Center Catch
- 900.084.06** 11/16" Center Catch
- 900.084.07** 1/2" Xtra-sturdy Case Bars
- 900.084.08** 5/8" Xtra-sturdy Case Bars
- 900.084.09** 3/8" Center Catch
- 900.084.10** 15/32" (12mm) Center Catch
- 900.084.11** 5/16" Case Spring Bars
- 900.084.12** 9/16" Center Catch

Refills **\$4.20 dz \$10.00/100 of a size**

1.30 mm Single Flange Clasp Spring Bar with Short Tips 999.098

Spring bar assortment for clasps includes five each of 11 sizes (10 of 18.0mm), 60 total. All are 1.30mm diameter. Swiss.

999.098 Assortment \$49.95

- 999.098.10** 10.0mm **999.098.16** 16mm
- 999.098.11** 11.0mm **999.098.17** 17mm
- 999.098.12** 12.0mm **999.098.18** 18mm
- 999.098.13** 13.0mm **999.098.19** 19mm
- 999.098.14** 14.0mm **999.098.20** 20mm
- 999.098.15** 15.0mm

Refills - **\$9.00 dz of a size**

1.30 mm Single Flange Clasp Spring Bar with Short Tips - X-Long 999.098L

Spring bar assortment for clasps includes 6 each of 5 sizes, 30 total. All are 1.30mm diameter. Swiss.

999.098L Assortment \$24.95

- 999.098.22** 22.0mm **999.098.28** 28.0mm
- 999.098.24** 24.0mm **999.098.30** 30.0mm
- 999.098.26** 26.0mm

Refills - **\$9.00 dz of a size**

1.00 mm Single Flange Clasp Spring Bar with Short Tips 999.096

Single flange stainless steel spring bars for ultra-thin clasps. All 1.00mm diameter. Six each of six sizes, 36 total.

999.096 Assortment \$23.95

- 999.096.15** 15.0mm **999.096.18** 18.0mm
- 999.096.16** 16.0mm **999.096.19** 19.0mm
- 999.096.17** 17.0mm **999.096.20** 20.0mm

Refills - **\$9.00 dz of a size**

1.00 mm Single Flange Clasp Spring Bar with Short Tips - X-Long 999.096L

Single flange stainless steel spring bars for ultra-thin clasps. All 1.00mm diameter.

Contains 6 each of 5 sizes, 30 total.

999.096L Assortment \$25.95

- 999.096.22** 22mm **999.096.28** 28mm
- 999.096.24** 24mm **999.096.30** 30mm
- 999.096.26** 26mm

Refills - **\$9.00 dz of a size**

1.00 mm Clasp Spring Bar with Short Tips 999.097

Single shoulder spring bars for ultra-thin clasps. All 1.00mm diameter. Swiss made. Assortment includes 60 total, 5 each of 12 sizes.

999.097 Assortment \$57.95

- 999.097.06** 06.0mm **999.097.14** 14mm
- 999.097.08** 08.0mm **999.097.15** 15mm
- 999.097.10** 10.0mm **999.097.16** 16mm
- 999.097.11** 11.0mm **999.097.17** 17mm
- 999.097.12** 12.0mm **999.097.18** 18mm
- 999.097.13** 13.0mm **999.097.20** 20.0mm

Additional Sizes not in Assortment:

- 999.097.07** 07.0mm **999.097.19** 19mm
- 999.097.09** 09.0mm

Refills - **\$12.00 dz of a size**

1.50 mm Single Flange Clasp Spring Bar with Short Tips 999.099

1.50mm diameter fits buckle 999.280. Swiss. Assortment contains 5 each of 11 sizes; 10 each of 18mm.

999.099 Assortment \$48.95

- 999.099.10** 10.0 **999.099.16** 16.0
- 999.099.11** 11.0 **999.099.17** 17.0
- 999.099.12** 12.0 **999.099.18** 18.0
- 999.099.13** 13.0 **999.099.19** 19.0
- 999.099.14** 14.0 **999.099.20** 20.0
- 999.099.15** 15.0

Refills - **\$9.00 dz of a size**

1.50 mm Single Flange Clasp Spring Bar with Short Tips - X-Long 999.099L

Spring bar assortment for clasps includes 6 each of 5 sizes, 30 total. All are 1.50mm diameter. Swiss.

999.099L Assortment \$25.95

- 999.099.22** 22mm **999.099.28** 28mm
- 999.099.24** 24mm **999.099.30** 30mm
- 999.099.26** 26mm

Refills - **\$9.00 dz of a size**

1.60mm Double Foldover Clasp Spring Bar 900.128

Flanged spring bars with rounded ends to fit our 999.128 Double Button Fossil style Clasps. Contains 12 each, 6 sizes, 72 total. All 1.60mm diameter.

900.128 Assortment \$19.95

- 900.128.12** 12mm **900.128.18** 18mm
- 900.128.14** 14mm **900.128.20** 20mm
- 900.128.16** 16mm **900.128.22** 22mm

Additional size not in Assortment:

- 900.128.24** 24mm

Refills - **\$4.20 dz of a size**

SPRING BAR ASSORTMENTS

Spring Bars to fit RLX 901.036



11 different styles of the most popular generic spring bars for ladies' and men's RLX watches, 36 pieces total.

901.036 Assortment \$39.95

- R23.1000** for Clasp 10mm
 - R23.1300** for Clasp 13mm
 - R23.1600** for Clasp 16mm
 - R23.6917N** New Style Ladies' Datejust
 - R23.9260** Ladies' 13mm
 - R23.9280** Men's 19mm
 - R23.9290** Men's 20mm
 - R23.9291** Submariner 20mm
 - R23.9380** Men's 20mm
 - R23.9382** President 20mm
 - R23.9382GP** President Gold Plated
- Refills - **\$2.75 ea**

Double Shoulder, Thin Curved, Extra-Thin, Telescopic Spring Bars 901.026



288 Spring Bars. In clear compartment box. Contains 12 each of 24 sizes.

901.026 Assortment \$24.95

- | | |
|--|-------------------------------------|
| Double Shoulder Regular Refills | Double Shoulder Thin Refills |
| 900.150.01 1/4" | 900.200.06 1/4" |
| 900.150.02 5/16" | 900.200.08 5/16" |
| 900.150.03 3/8" | 900.200.11 7/16" |
| 900.150.04 7/16" | 900.200.13 1/2" |
| 900.150.05 1/2" | 900.200.14 9/16" |
| 900.150.06 9/16" | 900.200.16 5/8" |
| 900.150.07 5/8" | 900.200.18 11/16" |
| 900.150.08 11/16" | 900.200.19 3/4" |
| 900.150.09 3/4" | |
| 900.150.10 13/16" | |

Double Shoulder Thin Curved Refills

- 900.915.03** 5/8"
- 900.915.04** 11/16"
- 900.915.05** 3/4"

Telescopic Refills

- 901.026.21** 9/16 - 5/8"
 - 901.026.22** 5/8 - 11/16"
 - 901.026.23** 11/16 - 3/4"
 - 901.026.24** 3/4 - 13/16"
- 900.150 Refills \$7.50/100 of a size**
900.915 Refills \$5.00/100 of a size
900.200 Refills \$4.20 dz \$10.00/100
901.026.21 - 901.026.24 Refills \$1.50 pair

Lever Spring Bar 900.145



42 Spring Bars (6 each of 7 sizes). Unique lever lets you compress and install with your finger. All are 1.50mm diameter.

900.145 Assortment \$25.95

- 900.145.10** 10mm **900.145.18** 18mm
 - 900.145.12** 12mm **900.145.20** 20mm
 - 900.145.14** 14mm **900.145.22** 22mm
 - 900.145.16** 16mm
- Refills **\$9.00 dz of a size**

Genuine Seiko Spring Bar 900.881

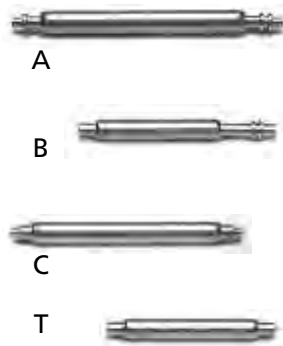

For Seiko, Pulsar and Lorus. 2 each of the 15 most popular numbers. In clear plastic compartment box.

900.881 Assortment \$37.95

- | Number | Seiko | Length | Diam. | Type |
|-------------------|--------|--------|-------|------|
| 900.881.01 | T060BS | 5.70 | 1.50 | T |
| 900.881.02 | T060AS | 5.80 | 1.20 | T |
| 900.881.03 | B080BS | 6.10 | 1.50 | B |
| 900.881.04 | B080AS | 6.20 | 1.20 | B |
| 900.881.05 | T070BS | 6.65 | 1.50 | T |
| 900.881.06 | T070AS | 6.70 | 1.50 | T |
| 900.881.07 | B090AS | 7.10 | 1.50 | B |
| 900.881.08 | T075BS | 7.15 | 1.50 | T |
| 900.881.09 | T080AS | 7.75 | 1.20 | T |
| 900.881.10 | A170CS | 13.05 | 1.80 | A |
| 900.881.11 | A180WS | 14.10 | 1.85 | A |
| 900.881.12 | STL-19 | 14.25 | 1.30 | A |
| 900.881.13 | A180BS | 16.00 | 1.50 | A |
| 900.881.14 | A200BS | 17.80 | 1.50 | A |
| 900.881.15 | C220FS | 20.50 | 2.50 | C |
- Refills-**\$2.75ea 3@\$2.50ea**

Female Spring Bars 900.087



2mm diameter female spring bars with holes in the ends.

Refills only - not an assortment.

- 900.087.06** 1/4" 6mm
- 900.087.08** 5/16" 8mm
- 900.087.10** 3/8" 10mm
- 900.087.11** 7/16" 11mm
- 900.087.13** 1/2" 13mm
- 900.087.14** 9/16" 14mm
- 900.087.16** 5/8" 16mm
- 900.087.18** 11/16" 18mm
- 900.087.19** 3/4" 19mm
- 900.087.21** 13/16" 21mm
- 900.087.22** 7/8" 22mm

Refills only-**\$3.50/pack of 2**
3@\$3.00 per pack of 2

Call Monday - Thursday 8:30 AM - 5:30 PM EST (6PM CST, 5PM MST, 4PM PST);

Friday 8:00AM - 5:00PM EST (4PM CST, 3PM MST, 2PM PST)

Call by 3:00PM Your Local Time (Mon-Thurs) for Overnight Delivery

1-800-487-0408

Please order all assortments and refills by SKU number. Thank you!

Stainless Steel Case Back Screw 900.639

170 Stainless steel mini watch case screws, 10 each of 17 sizes (mm).

900.639 Assortment \$34.95

SKU	Head Diam.	Thread Diam.	Thread Length	Overall Length
900.639.01	1.4	1.0	1.5	1.90
900.639.02	1.6	1.0	2.0	2.50
900.639.03	1.6	1.0	2.2	2.70
900.639.04	1.8	1.0	2.5	3.00
900.639.05	1.8	1.0	2.7	3.25
900.639.06	1.5	1.2	1.6	2.15
900.639.07	1.5	1.2	2.0	2.50
900.639.08	2.0	1.2	2.4	3.00
900.639.09	2.2	1.2	2.8	3.30
900.639.10	2.5	1.2	3.2	3.75
900.639.11	2.3	1.2	3.6	4.15
900.639.12	2.5	1.3	2.8	3.45
900.639.13	2.0	1.4	1.8	2.25
900.639.14	2.0	1.4	2.2	2.75
900.639.15	2.5	1.4	2.6	3.40
900.639.16	2.2	1.4	3.0	3.60
900.639.17	2.2	1.4	3.3	4.00

Refills - **\$5.00 pk of 10**

Case Screws 959.035

240 Stainless steel screws for watch cases in 24 bottles. Swiss made. Three head types: Cheese, Fillister and Chamfer.

959.035 Assortment \$119.95

D=Thread Diameter
L=Thread Length
H=Head Type

Head Types:



C = Cheese Flat



F= Fillister Round



CH = Chamfer Countersunk

Number	D	L	H	Number	D	L	H
959.035.01	.70	1.35	C	959.035.13	1.02	1.10	F
959.035.02	.70	1.55	C	959.035.14	1.02	1.30	F
959.035.03	.70	1.90	F	959.035.15	1.02	1.35	F
959.035.04	.70	2.00	CH	959.035.16	1.03	1.50	C
959.035.05	.80	1.70	F	959.035.17	1.22	1.00	C
959.035.06	.80	1.80	C	959.035.18	1.22	1.10	CH
959.035.07	.80	2.00	C	959.035.19	1.22	1.30	F
959.035.08	.80	3.30	F	959.035.20	1.23	1.40	F
959.035.09	.90	1.55	F	959.035.21	1.42	1.45	F
959.035.10	.90	2.00	F	959.035.22	1.43	1.30	F
959.035.11	.90	2.50	CH	959.035.23	1.43	1.90	F
959.035.12	.90	3.80	F	959.035.24	1.46	1.00	C

Refills - **\$3.25ea 3@ \$2.75ea 6@ \$2.50ea**



Steel Case Screws 959.016

959.016 Assortment of 120 \$62.95

No refills available.

18K Yellow Gold Case Screws

Individual screws for high grade gold watches. 2.20mm long, 1.70mm head diameter.

- 922.070** 18KY 0.65mm thread **\$19.95 ea**
- 922.080** 18KY 0.75mm thread **\$19.95 ea**
- 922.090** 18KY 0.85mm thread **\$19.95 ea**
- 922.100** 18KY 0.95mm thread **\$19.95 ea**

Flat Head Case Back Screw 999.240

180 Stainless Steel Flat Head Mini Watch Case Screws, 10 each size.

999.240 Assortment \$34.95

SKU	Head Diam.	Thread Diam.	Thread Length	Overall Length
999.240.500	1.20	1.00	1.50	2.20
999.240.501	1.40	1.00	1.70	2.20
999.240.502	1.50	1.00	1.60	2.30
999.240.503	1.50	1.00	2.00	2.65
999.240.504	1.60	1.00	2.00	2.60
999.240.505	1.60	1.00	2.20	2.75
999.240.506	1.80	1.00	1.50	2.15
999.240.507	1.80	1.00	1.80	2.50
999.240.508	1.80	1.00	2.50	3.20
999.240.509	1.80	1.00	2.70	3.35
999.240.510	1.80	1.40	1.50	2.20
999.240.511	1.80	1.40	1.80	2.40
999.240.512	2.00	1.20	2.20	2.90
999.240.513	2.00	1.20	2.50	3.15
999.240.514	2.00	1.40	2.40	2.65
999.240.515	2.00	1.40	2.40	3.05
999.240.516	2.50	1.40	2.60	3.20
999.240.517	2.50	1.40	3.00	3.60

Refills - **\$5.00 pk of 10**

Round Head Case Back Screw 999.241

180 Stainless Steel Round Head Mini Watch Case Screws, 10 each size.

999.241 Assortment \$34.95

SKU	Head Diam.	Thread Diam.	Thread Length	Overall Length
999.241.600	2.20	1.20	2.80	3.50
999.241.601	2.20	1.20	3.00	3.75
999.241.602	2.20	1.40	2.60	3.30
999.241.603	2.20	1.40	2.80	3.65
999.241.604	2.30	1.20	3.30	4.00
999.241.605	2.30	1.20	3.60	4.25
999.241.606	2.30	1.40	3.00	3.80
999.241.607	2.30	1.40	3.40	4.15
999.241.608	2.50	1.20	2.80	3.55
999.241.609	2.50	1.20	3.20	4.00
999.241.610	2.50	1.40	2.60	3.45
999.241.611	2.50	1.40	3.00	3.85
999.241.612	2.70	1.20	3.20	4.00
999.241.613	2.70	1.20	3.60	4.35
999.241.614	2.70	1.40	3.00	3.80
999.241.615	2.70	1.40	3.60	4.00
999.241.616	2.90	1.40	3.60	4.45
999.241.617	2.90	1.40	3.30	4.15

Refills - **\$5.00 pk of 10**

Phillips Head Case Back Screw 999.242

170 Stainless Steel Phillips Head Mini Watch Case Screws, 10 each size.

999.242 Assortment \$34.95

SKU	Head Diam.	Thread Diam.	Thread Length	Overall Length
999.242.700	1.40	1.00	1.50	2.10
999.242.701	1.50	1.20	1.60	2.20
999.242.702	1.50	1.20	2.00	2.60
999.242.703	1.60	1.00	2.00	2.60
999.242.704	2.30	1.20	3.30	2.80
999.242.705	1.80	1.00	2.50	3.25
999.242.706	1.80	1.00	2.40	3.50
999.242.707	2.00	1.40	1.80	3.00
999.242.708	2.00	1.40	1.80	2.50
999.242.709	2.00	1.40	2.20	2.80
999.242.710	2.20	1.20	2.80	3.55
999.242.711	2.20	1.40	3.00	3.80
999.242.712	2.20	1.40	3.30	4.00
999.242.713	2.30	1.20	3.60	4.30
999.242.714	2.50	1.20	3.60	3.90
999.242.715	2.50	1.30	2.80	3.50
999.242.716	2.50	1.40	2.60	3.40

Refills - **\$5.00 pk of 10**

SCREW ASSORTMENTS

Bracelet Screw 900.055

55 pieces (5 each of 11 sizes) screws for repairing watch bracelets and clasps.

900.055 Assortment \$34.95

Thread Shank

Number	Type	Diam.	Diam.	Length
900.055.01	A	1.00	1.00	5.75
900.055.02	A	1.00	1.00	7.25
900.055.03	A	1.00	1.00	9.00
900.055.04	A	1.00	1.20	11.50
900.055.05	A	1.00	1.00	14.00
900.055.06	A	1.20	1.20	5.75
900.055.07	A	1.20	1.20	6.75
900.055.08	A	1.20	1.20	8.50
900.055.09	A	1.55	---	2.50
900.055.10	B	1.40	1.00	15.00
900.055.11	B	1.00	0.65	15.50

Refills - **\$2.75/pk of 3**

TYPE A TYPE B



Bracelet Screw 959.025

30 Swiss bracelet screws, all 18.00mm long, 13.00 mm thread length, 5 diameter sizes. May be cut to size. Sold in pairs.

959.025 Assortment \$39.95

959.025.01 0.90mm

959.025.02 1.00mm

959.025.03 1.20mm

959.025.04 1.40mm

959.025.05 1.60mm

Refills **\$3.50/pair 3 pairs@\$3.00/pair**



Yellow Screw for Solid Link Clasp 900.068

Assortment of all yellow screws with 1.2mm threads, 4 each of 17 sizes.

900.068 Assortment \$42.95

900.068.01 4.0mm **900.068.10** 10.4mm

900.068.02 4.8mm **900.068.11** 11.3mm

900.068.03 5.5mm **900.068.12** 12.0mm

900.068.04 5.8mm **900.068.13** 13.0mm

900.068.05 6.5mm **900.068.14** 14.4mm

900.068.06 6.8mm **900.068.15** 15.5mm

900.068.07 7.5mm **900.068.16** 17.0mm

900.068.08 8.0mm **900.068.17** 19.5mm

900.068.09 9.8mm

Refills- **\$3.25/3 pcs. of a size**



Screw Pins to fit RLX Bracelets 999.658

Assortment of 90 generic Stainless Steel pins to fit RLX, 5 each of 18 sizes.

999.658 Assortment \$34.95

Number	Thread	Diameter	Length
999.658.01	0.80	0.95	8.80
999.658.02	1.00	1.30	12.10
999.658.03	1.10	1.70	13.60
999.658.04	1.10	1.20	15.00
999.658.05	1.20	1.70	8.60
999.658.06	1.20	1.20	10.00
999.658.07	1.20	1.70	11.00
999.658.08	1.20	1.70	13.00
999.658.09	1.20	1.70	14.00
999.658.10	1.20	1.60	14.40
999.658.11	1.20	1.50	15.20
999.658.12	1.20	1.20	15.50
999.658.13	1.40	1.40	10.00
999.658.14	1.40	1.70	14.00
999.658.15	1.40	1.70	15.00
999.658.16	1.40	1.50	15.90
999.658.17	1.40	1.50	17.30
999.658.18	1.40	1.50	19.40

999.658.01 0.80 0.95 8.80

999.658.02 1.00 1.30 12.10

999.658.03 1.10 1.70 13.60

999.658.04 1.10 1.20 15.00

999.658.05 1.20 1.70 8.60

999.658.06 1.20 1.20 10.00

999.658.07 1.20 1.70 11.00

999.658.08 1.20 1.70 13.00

999.658.09 1.20 1.70 14.00

999.658.10 1.20 1.60 14.40

999.658.11 1.20 1.50 15.20

999.658.12 1.20 1.20 15.50

999.658.13 1.40 1.40 10.00

999.658.14 1.40 1.70 14.00

999.658.15 1.40 1.70 15.00

999.658.16 1.40 1.50 15.90

999.658.17 1.40 1.50 17.30

999.658.18 1.40 1.50 19.40

Refills -- **\$6.25/pack of 10**



Quartz Screws 900.240

240 piece screw assortment for quartz watches. Screws for bridges, setting lever springs, minutes train covers, date indicator guards, cases (1/2 head and round), circuits, coils, coil guards and stators, battery clamps, and with shoulders. Swiss.

900.240 Assortment \$64.95

No refills available.

Swiss Quartz Watch Screws 909.201Q

909.201Q Assortment of 100 \$18.95

No refills available.

Swiss Pocket Watch Screws 909.201

909.201 Assortment of 100 \$29.95

No refills available.

Screws for Pocket Watches 909.211

36 dozen assorted sizes, 15 different types for pallet bridges, bridges, cases, dials, clicks, endstones, winding wheels, studs, set levers, set lever springs, with shoulders and regulator springs. Swiss.

909.211 Assortment \$67.50

No refills available.

Screws for Wrist Watches 909.210

36 dozen assorted sizes, 15 different types for pallet bridges, bridges, cases, dials, clicks, endstones, winding wheels, studs, set levers, set lever springs, with shoulders and oscill. weights. Swiss made.

909.210 Assortment \$59.95

No refills available.

Screws for Clocks 909.252

100 assorted steel and brass screws for all kinds of clocks. Bulk, Swiss made.

909.252 Assortment \$39.95

No refills available. Limited supply.

Bridge/Module Screws 910.229

50 Assorted Bergen 10233 Coil Screws.

910.233 Assortment \$32.95

No refills available.

910.229 Assortment of 50 \$23.95

No refills available.

CASE & CROWN TUBE ASSORTMENTS

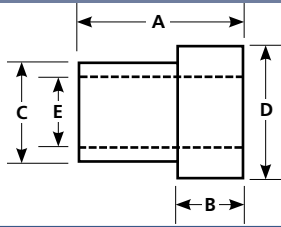

1.30 & 1.50mm Case Tubes 956.045

30 piece assortment in 10 bottles, 3 ea size. 1.30 and 1.50 crown tube diameters. Swiss made.

956.045 Assortment \$24.95					
Number	A Lgth	B Lgth	C Diam.	D Diam.	E Diam.
956.045.21	1.80	1.00	1.30	1.50	1.00
956.045.22	2.30	1.20	1.30	1.50	1.10
956.045.23	2.40	---	---	1.50	1.15
956.045.24	2.40	1.20	1.20	1.50	1.00
956.045.25	2.50	1.20	1.40	1.50	1.20
956.045.26	2.60	1.20	1.30	1.50	1.10
956.045.27	1.80	1.20	1.00	1.30	0.80
956.048.28	1.90	1.05	1.20	1.30	1.00
956.045.29	1.90	1.05	1.10	1.30	0.90
956.045.30	1.90	---	---	1.30	1.10

Refills - \$1.75ea
3@\$1.50ea 6@\$1.40ea 12@\$1.30ea

1.30-1.60mm Bergeon Case Tubes 904.014

Bergeon 4012-B 1.30 - 1.60mm crown ends. Refills only.

Number	A Lgth	B Lgth	C Diam.	D Diam.	E Diam.
904.014.25	2.00	---	---	1.30	0.90
904.014.26	2.50	1.20	1.50	1.60	1.25
904.014.27	2.00	1.20	1.50	1.60	1.25
904.014.28	2.70	1.20	1.50	1.60	1.30
904.014.29	2.30	1.20	1.50	1.60	1.10
904.014.30	2.40	1.20	1.50	1.60	1.25
904.014.31	2.70	1.40	1.50	1.60	1.25
904.014.32	3.00	1.40	1.50	1.60	1.15
904.014.33	2.60	1.40	1.50	1.60	1.25
904.014.34	2.40	1.20	1.40	1.50	1.15
904.014.35	2.50	1.20	1.40	1.50	1.15
904.014.36	<i>Discontinued</i>				

Refills - \$1.75ea
3@\$1.50ea 6@\$1.40ea 12@\$1.30ea

1.6mm Waterproof Case Tubes 956.035

Diameters: 1.60 crown tube, 1.50 case posts, 1.25 inside. Swiss. Refills only.

Number	A Lgth	B Lgth	C Diam.	D Diam.	E Diam.
956.035.01	2.20	1.20	1.50	1.60	1.25
956.035.02	2.40	1.20	1.50	1.60	1.25
956.035.03	2.40	1.40	1.50	1.60	1.25
956.035.04	2.50	1.00	1.50	1.60	1.25
956.035.05	2.60	1.20	1.50	1.60	1.25
956.035.06	2.60	1.40	1.50	1.60	1.25
956.035.07	2.80	1.20	1.50	1.60	1.25
956.035.08	2.80	1.40	1.50	1.60	1.25
956.035.09	3.00	1.40	1.50	1.60	1.25
956.035.10	3.20	1.40	1.50	1.60	1.25

Refills - \$1.75ea
3@\$1.50ea 6@\$1.40ea 12@\$1.30ea

1.8mm Waterproof Case Tubes 956.036

1.80 crown tube diameters. Refills only.

Number	A Lgth	B Lgth	C Diam.	D Diam.	E Diam.
956.036.11	2.20	----	1.80	1.80	1.40
956.036.12	2.60	1.40	1.70	1.80	1.35
956.036.13	2.60	1.50	1.60	1.80	1.30
956.036.14	2.70	1.20	1.60	1.80	1.25
956.036.15	2.80	1.50	1.60	1.80	1.40
956.036.16	3.00	1.40	1.60	1.80	1.35
956.036.17	3.00	1.50	1.70	1.80	1.40
956.036.18	3.00	1.20	1.70	1.80	1.30
956.036.19	3.40	1.40	1.60	1.80	1.35
956.036.20	3.50	1.50	1.70	1.80	1.30

Refills - order by SKU# above \$1.75ea
3@\$1.50ea 6@\$1.40ea 12@\$1.30ea

2.00mm Bergeon Case Tubes 904.013

Case Tubes for Waterproof Watches. 2.00mm crown end. Refills only.

Number	A Lgth	B Lgth	C Diam.	D Diam.	E Diam.
904.013.13	2.40	1.15	1.80	2.00	1.40
904.013.14	2.80	1.15	1.80	2.00	1.40
904.013.15	<i>Discontinued</i>				
904.013.16	3.30	1.50	1.80	2.00	1.50
904.013.17	3.90	1.50	1.80	2.00	1.50
904.013.18	4.50	1.50	1.80	2.00	1.50
904.013.19	3.30	1.15	1.90	2.00	1.40
904.013.20	3.80	1.15	1.90	2.00	1.40
904.013.21	3.00	1.50	1.90	2.00	1.50
904.013.22	3.60	1.50	1.90	2.00	1.50
904.013.23	4.20	1.50	1.90	2.00	1.50
904.013.24	4.80	1.50	1.90	2.00	1.50

Refills - \$1.75ea
3@\$1.50ea 6@\$1.40ea 12@\$1.30ea

2.50mm Bergeon Case Tubes 904.012

Bergeon 4012 2.50mm crown end. Refills only.

Number	A Lgth	B Lgth	C Diam.	D Diam.	E Diam.
904.012.01	3.20	1.90	1.90	2.50	1.55
904.012.02	3.85	1.90	1.90	2.50	1.55
904.012.03	4.95	1.90	1.90	2.50	1.55
904.012.04	5.05	1.90	1.90	2.50	1.60
904.012.05	3.55	1.90	2.00	2.50	1.55
904.012.06	4.25	1.90	2.00	2.50	1.55
904.012.07	4.45	1.90	2.00	2.50	1.55
904.012.08	4.75	1.90	2.00	2.50	1.55
904.012.09	3.20	1.90	2.20	2.50	1.80
904.012.10	3.50	1.90	2.20	2.50	1.75
904.012.11	4.05	1.90	2.20	2.50	1.85
904.012.12	4.35	1.90	2.20	2.50	1.70

Refills - \$1.75ea
3@\$1.50ea 6@\$1.40ea 12@\$1.30ea

CASE & CROWN TUBE ASSORTMENTS

Brass Case Tubes 900.628

90 piece assortment, 5 each of 18 sizes.

900.628 Assortment \$16.95

Number	Length	Diameters	Number	Length	Diameters
900.628.01	2.40	1.50 x 1.40	900.628.10	2.40	2.30 x 2.00
900.628.02	2.60	1.50 x 1.40	900.628.11	2.20	2.00 x 1.60
900.628.03	1.90	1.60 x 1.40	900.628.12	2.20	2.00 x 1.70
900.628.04	1.90	1.60 x 1.50	900.628.13	3.00	2.00 x 1.80
900.628.05	2.50	1.60 x 1.50	900.628.14	2.50	2.00 x 2.00
900.628.06	2.30	1.60 x 1.60	900.628.15	2.50	2.50 x 1.80
900.628.07	1.80	1.80 x 1.60	900.628.16	3.00	2.50 x 2.30
900.628.08	2.50	1.80 x 1.60	900.628.17	4.00	2.50 x 2.00
900.628.09	3.00	2.30 x 1.60	900.628.18	3.00	2.50 x 2.50

Refills- **\$3.50/pk of 12**

Hunting Case Tubes 956.055

30 piece assortment of tubes for hunting case watches in ten bottles. Swiss made. 10mm long. Contains 3 each. Diameters = Inside x Outside

956.055 Assortment \$28.95

Number	Diameters	Number	Diameters
956.055.01	0.95 x 1.20	956.055.06	1.55 x 2.00
956.055.02	1.05 x 1.20	956.055.07	1.60 x 2.20
956.055.03	1.20 x 1.50	956.055.08	1.55 x 2.50
956.055.04	1.45 x 1.80	956.055.09	1.90 x 2.60
956.055.05	1.45 x 1.90	956.055.10	2.10 x 2.90

Refills **\$3.25ea 3@\$2.75ea 6@\$2.50ea**

Stainless Steel Case Tubes 999.628

90 piece assortment, 5 each of 18 sizes.

999.628 Assortment \$24.95

Number	A Lgth	B Lgth	C Diam	D Diam	E Diam
999.628.01	2.00	1.10	1.40	1.50	1.10
999.628.02	2.00	1.20	1.50	1.60	1.20
999.628.03	2.60	1.40	1.55	1.60	1.30
999.628.04	2.20	1.20	1.50	1.60	1.35
999.628.05	3.15	1.60	1.50	1.60	1.20
999.628.06	3.30	1.50	1.60	1.80	1.30
999.628.07	3.40	2.00	1.90	2.00	1.40
999.628.08	4.15	1.50	1.90	2.00	1.45
999.628.09	2.50	1.50	1.85	2.00	1.50
999.628.10	3.30	1.50	1.80	2.00	1.55
999.628.11	3.90	2.00	1.80	1.90	1.45
999.628.12	3.30	1.50	1.65	2.00	1.30
999.628.13	3.50	1.50	1.70	2.00	1.45
999.628.14	3.50	1.50	1.90	2.50	1.60
999.628.15	5.00	2.00	1.90	2.50	1.55
999.628.16	3.20	1.60	2.00	2.50	1.65
999.628.17	4.75	1.70	2.00	2.50	1.70
999.628.18	4.00	2.00	2.20	2.50	1.80

Refills - **\$3.95/10 pack**

Hunting Case Tubes 909.010

100 Brass tubes for hunting cases. Swiss made. Bulk.

909.010 Assortment \$42.95

No refills available.

Swiss Crown Tubes 909.006

100 Nickel Tubes to hold watch crowns.

909.006 Assortment \$34.95

No refills available.

Waterproof Case Tubes 909.003,004,008

100 Case Tubes 2.00 & 2.50, 1.60 or 1.30 & 1.50 diameters. Swiss made. Bulk.

909.003 2.00 & 2.50 diameters \$26.95

909.004 1.60 diameter \$24.95

909.008 1.30 & 1.50 diameters \$24.95

No refills available.



**Call by 3:00PM
Your Local Time
(Mon-Thurs)
for Overnight Delivery
1.800.487.0408**

O-Ring Waterproof Crowns 900.007

"O" Ring waterproof crowns for Swiss and American watches. New modern style has fewer knurls for easy winding. Pressure tested. Flush posts. Two each, white & yellow, 48 pieces total.

900.007 Assortment \$79.95

White	Yellow	Diameter	Opening	Tap
900.007.05	900.007.01	4.00	2.0	10
900.007.06	900.007.02	4.00	2.0	8
900.007.07	900.007.03	4.00	2.5	10
900.007.08	900.007.04	4.00	2.5	8
900.007.13	900.007.09	5.00	2.0	10
900.007.14	900.007.10	5.00	2.0	8
900.007.15	900.007.11	5.00	2.5	10
900.007.16	900.007.12	5.00	2.5	8
900.007.21	900.007.17	5.50	2.0	10
900.007.22	900.007.18	5.50	2.0	8
900.007.23	900.007.19	5.50	2.5	10
900.007.24	900.007.20	5.50	2.5	8

Refills- **\$4.50 ea**

3@\$4.25ea 6@\$4.00ea 12@\$3.75ea



Waterproof Crowns 900.091

Contains 1 each white & yellow waterproof crowns, 36 sizes, 72 pcs. total.

900.091 Assortment \$89.95

Number	Color	Diam.	Open	Tap	Post
900.091.01	Y & W	3.00	1.50	12	Flush
900.091.02	Y & W	3.00	1.50	13	Flush
900.091.03	Y & W	3.00	1.60	10	-0.10
900.091.04	Y & W	3.00	1.60	11	-0.10
900.091.05	Y & W	3.00	1.60	12	-0.10
900.091.06	Y & W	3.00	1.60	13	-0.10
900.091.07	Y & W	3.00	1.60	10	-0.10
900.091.08	Y & W	3.00	1.60	11	-0.10
900.091.09	Y & W	3.00	1.60	12	-0.10
900.091.10	Y & W	3.00	1.60	10	+1.00
900.091.11	Y & W	3.00	1.60	11	+1.00
900.091.12	Y & W	3.00	1.60	12	+1.00
900.091.13	Y & W	3.50	1.60	10	-0.15
900.091.14	Y & W	3.50	1.60	11	-0.15
900.091.15	Y & W	3.50	1.60	12	-0.15
900.091.16	Y & W	3.50	1.60	10	+0.50
900.091.17	Y & W	3.50	1.60	11	+0.50
900.091.18	Y & W	3.50	1.60	12	+0.50
900.091.19	Y & W	3.50	1.60	10	+1.00
900.091.20	Y & W	3.50	1.60	11	+1.00
900.091.21	Y & W	3.50	1.60	12	+1.00
900.091.22	Y & W	3.50	1.80	10	Flush
900.091.23	Y & W	3.50	1.80	11	Flush
900.091.24	Y & W	3.50	1.80	12	Flush
900.091.25	Y & W	3.50	2.00	10	Flush
900.091.26	Y & W	3.50	2.00	11	Flush
900.091.27	Y & W	3.50	2.00	12	Flush
900.091.28	Y & W	3.50	2.00	10	-0.10
900.091.29	Y & W	3.50	2.00	11	-0.10
900.091.30	Y & W	3.50	2.00	12	-0.10
900.091.31	Y & W	3.50	2.00	10	+0.50
900.091.32	Y & W	3.50	2.00	11	+0.50
900.091.33	Y & W	3.50	2.00	12	+0.50
900.091.34	Y & W	4.00	2.00	10	-0.10
900.091.35	Y & W	4.00	2.00	10	-0.10
900.091.36	Y & W	4.00	2.00	11	-0.10

Refills specify Yellow or White **\$4.25 ea**
3@4.00 ea 6@\$3.75ea 12@\$3.50ea



Stainless Steel Waterproof Crowns 900.009

Assortment contains one each of 12 waterproof crowns for skindiver watches. Double gasket, heavy knurl.

900.009 Assortment \$42.95

Number	Diam.	Open.	Thread	Tap	Post
900.009.01*	5.50	2.00	0.90	10	Flush
900.009.02*	5.50	2.00	1.10	8	Flush
900.009.03	5.50	2.00	0.90	10	1.00
900.009.04*	5.50	2.00	1.10	8	1.00
900.009.05	5.50	2.50	0.90	10	Flush
900.009.06	5.50	2.50	1.10	8	Flush
900.009.07*	5.50	2.50	0.90	10	1.00
900.009.08	5.50	2.50	1.10	8	1.00
900.009.09	6.00	2.50	0.90	10	3.00
900.009.10	6.00	2.50	1.10	8	3.00
900.009.11	5.50	2.50	1.20	6	Flush
900.009.12	5.50	2.50	1.20	6	1.00

Additional Sizes not in Assortment:

900.009.13	5.50	2.00	--	9	Flush
900.009.14	5.50	2.50	---	9	1.00

*No Refills for 900.009.01, .02, .04, .07.

Refills- **\$5.00 ea 3@\$4.00ea**

Limited Supply.



Rose Gold Waterproof Crowns 900.338

30 waterproof crowns, 2 of each size. All Rose Gold, Tap 10.

900.338 Assortment \$57.95

SKU	Diameter	Opening
900.338.01	3.0	1.6mm
900.338.02	3.5	2.0mm
900.338.03	4.0	2.0mm
900.338.04	4.5	2.0mm
900.338.05	4.5	2.5mm
900.338.06	5.0	2.0mm
900.338.07	5.0	2.5mm
900.338.08	5.5	2.0mm
900.338.09	5.5	2.5mm
900.338.10	6.0	2.0mm
900.338.11	6.0	2.5mm
900.338.12	6.5	2.0mm
900.338.13	6.5	2.5mm
900.338.14	7.0	2.0mm
900.338.15	7.0	2.5mm

Refills- **\$5.00ea 3@\$4.50ea**



Black Waterproof Crowns 900.331

24 waterproof crowns, two each of 12 sizes, Black, Tap 10.

900.331 Assortment \$52.95

SKU	Diameter	Opening
900.331.01	2.50	1.50
900.331.02	3.00	1.60
900.331.03	3.50	2.00
900.331.04	4.00	2.00
900.331.05	4.50	2.00
900.331.06	4.50	2.50
900.331.07	5.00	2.00
900.331.08	5.00	2.50
900.331.09	6.00	2.00
900.331.10	6.00	2.50
900.331.11	7.00	2.00
900.331.12	7.00	2.50

Refills **-\$5.00 ea 3@\$4.50ea**



CROWN ASSORTMENTS - WATERPROOF

Japanese Waterproof Crowns 905.130



36 all yellow (two each of 18 numbers).

905.130 Assortment \$67.95

Number	Style	Color	Diam.	Opening	Tap
905.130.5131	WP	Yellow	3.50	1.8	12
905.130.5133	WP	Yellow	3.50	1.6	12
905.130.5135	WP	Yellow	3.50	1.6	12
905.130.5137	WP	Yellow	4.00	1.6	10
905.130.5139	WP	Yellow	4.00	1.8	10
905.130.5141	Japanese	Yellow	3.50		10
905.130.5143	Japanese	Yellow	3.75		10
905.130.5145	Japanese	Yellow	3.50		10
905.130.5147	Japanese	Yellow	3.50		10
905.130.5149	Japanese	Yellow	3.50		11
905.130.5151	Japanese	Yellow	3.00		11
905.130.5153	Japanese	Yellow	4.00		10
905.130.5155	Japanese	Yellow	4.00		9
905.130.5157	WP	Yellow	3.50	1.8	11
905.130.5159	Japanese	Yellow	4.00		9
905.130.5161	Japanese	Yellow	3.50		11
905.130.5163	Japanese	Yellow	3.50		11
905.130.5165	Japanese	Yellow	3.00		11

Refills- **\$4.25 ea 3@\$4.00ea**

Japanese Waterproof Crowns 905.170



All yellow except 5551 & 5563 are white.
2 each, 36 pieces total.

905.170 Assortment \$64.95

Number	Style	Color	Diam.	Opening	Tap
905.170.5113	WP	Yellow	2.80	1.6	12
905.170.5119	WP	Yellow	3.00	1.6	10
905.170.5133	WP	Yellow	3.50	1.6	12
905.170.5135	WP	Yellow	3.50	1.6	12
905.170.5145	Japanese	Yellow	3.50		10
905.170.5149	Japanese	Yellow	3.50		11
905.170.5151	Japanese	Yellow	3.00		11
905.170.5157	WP	Yellow	3.50	1.8	11
905.170.5159	Japanese	Yellow	4.00		9
905.170.5161	Japanese	Yellow	3.50		11
905.170.5163	Japanese	Yellow	3.50		11
905.170.5165	Japanese	Yellow	3.50		11
905.170.5541	Japanese	Yellow	4.00		11
905.170.5547	Japanese	Yellow	3.50		11
905.170.5551	WP	White	4.50	2.0	10
905.170.5563	Japanese	White	4.00		10
905.170.5591	Japanese	Yellow	3.50		11
905.170.5593	Japanese	Yellow	3.50		11

Refills- **\$4.25 ea 3@\$4.00ea**

Crowns for Swiss Army Watches 905.520



8 Crowns, Double O-Ring, Tap 10. Contains one each size, white & yellow.

905.520 Assortment \$28.95

White	Yellow	Diam	Tube	Height
905.526	905.526Y	4.50	2.50	3.40
905.630	905.630Y	4.00	2.00	3.00
905.631	905.631Y	4.50	2.00	3.40
905.632	905.632Y	5.00	2.00	3.50

Refills, White- **\$5.50 ea 3@5.00 ea**

Refills, Yellow- **\$6.50 ea 3@6.00 ea**

White Double O-Ring Waterproof 2mm Post 905.518

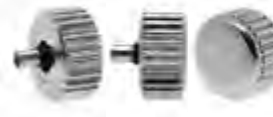

White stainless 2.0mm post, tap 10. 24 pieces.

905.518 Assortment \$47.95

SKU	Diam	Tube	Height
905.518.01	4.0	2.0	3.0mm
905.518.02	4.5	2.0	3.0mm
905.518.03	5.0	2.0	3.0mm
905.518.04	5.5	2.0	3.5mm
905.518.05	6.0	2.0	3.5mm
905.518.06	6.5	2.0	3.5mm
905.518.07	4.5	2.5	3.0mm
905.518.08	5.0	2.5	3.0mm
905.518.09	5.5	2.5	3.5mm
905.518.10	6.0	2.5	3.5mm
905.518.11	6.5	2.5	3.5mm
905.518.12	7.0	2.5	3.5mm

Refills- **\$5.50 ea 3@\$5.00ea**

Yellow Double O-Ring Waterproof 2mm Post 905.519



Yellow plated stainless 2.0mm post, tap 10. 24 pieces.

905.519 Assortment \$52.95

SKU	Diam	Tube	Height
905.519.01	4.0	2.0	3.0mm
905.519.02	4.5	2.0	3.0mm
905.519.03	5.0	2.0	3.0mm
905.519.04	5.5	2.0	3.5mm
905.519.05	6.0	2.0	3.5mm
905.519.06	6.5	2.0	3.5mm
905.519.07	4.5	2.5	3.0mm
905.519.08	5.0	2.5	3.0mm
905.519.09	5.5	2.5	3.5mm
905.519.10	6.0	2.5	3.5mm
905.519.11	6.5	2.5	3.5mm
905.519.12	7.0	2.5	3.5mm

Refills-order by SKU **\$5.50 ea 3@\$5.00ea**

Additional Swiss Army Crowns not in assortment:

White	Yellow	Diam	Tube	Height	
905.629			5.00	2.50	3.00
905.633	905.633Y		5.50	2.00	3.00
905.634	905.634Y		5.00	2.50	3.50
905.635	905.635Y		6.00	2.50	4.50
907.786	907.786Y		6.00	2.00	3.00
905.376	905.376Y		6.00	2.50	4.00
905.636	905.636Y		7.00	2.00	4.00
905.637	905.637Y		7.00	2.50	4.00
905.638	905.638Y		5.50	2.50	5.50
907.787	907.787Y		8.00	2.00	4.00
907.788	907.788Y		8.00	2.50	4.00

Refills, White- **\$5.50 ea 3@5.00 ea**

Refills, Yellow- **\$6.50 ea 3@6.00 ea**

CROWN ASSORTMENTS - WATERPROOF

Waterproof Crowns for Quartz 905.610

36 pieces, 3 each yellow and 1 each white stainless steel.

905.610 Assortment **\$47.95**



White SKU	Yellow SKU	Diam.	Tube	Tap
905.610.5629	905.610.5611	3.0	1.6	12
905.610.5631	905.610.5613	3.0	1.6	10
905.610.5633	905.610.5615	3.5	1.6	12
905.610.5635	905.610.5617	3.5	1.6	10
905.610.5637	905.610.5619	3.5	1.8	12
905.610.5639	905.610.5621	3.5	1.8	10
905.610.5641	905.610.5623	3.5	2.0	10
905.610.5643	905.610.5625	4.0	2.0	10
905.610.5645	905.610.5627	4.5	2.0	10

Refills- **\$4.25 ea**

Bergeon Waterproof Crowns 906.612

White and Yellow Gold Plated. Swiss. **Refills only**, no assortment available. Ltd supply.

Number	Color	Diam.	Tube	Tap	Depth
906.612.01	Y & W	2.50	1.30	13	1.05
906.612.02	Y & W	2.50	1.30	12	1.05
906.612.03	Y & W	2.80	1.30	12	1.05
906.612.05	---- W	3.00	1.60	10	1.20
906.612.07	---- W	3.50	1.60	10	1.20
906.612.09	Y & W	4.00	1.60	10	1.40
906.612.11	Y ----	4.50	2.00	10	1.50

Above Refills Only - Limited Qty. - Specify Yellow or White ...
\$5.25 ea 3@ \$4.75 ea



Domed Waterproof Crowns 906.748

Domed crowns for quartz watches. Swiss made.

Refills only, no Assortment.

White	Yellow	Diam	Tube	Tap
906.748.01W	906.748.01	2.80	1.50	12
906.748.02W	906.748.02	2.80	1.60	10
906.748.03W	906.748.03	3.00	1.60	10
906.748.04W	906.748.04	3.00	1.80	10
906.748.05W	906.748.05	3.50	1.60	10
906.748.06W	906.748.06	3.50	2.00	10
---	906.748.07	3.80	1.60	10
906.748.08W	---	3.80	2.00	10
906.748.09W	906.748.09	4.00	1.60	10
906.748.10W	906.748.10	4.00	2.00	10
906.748.12W	906.748.12	4.50	2.00	10
906.748.13W	906.748.13	4.50	2.50	10

Refills

\$5.25ea 3@ \$4.75ea 6@ \$4.25ea



Stainless Steel Waterproof Short Post 2.5 999.200

2.5 Tube, Tap 10. 24 pieces.

999.200 Assortment **\$43.95**

Number	Diam	Tube	Number	Diam	Tube
999.200.01	4.5	2.5	999.200.07	7.5	2.5
999.200.02	5.0	2.5	999.200.08	8.0	2.5
999.200.03	5.5	2.5	999.200.09	8.5	2.5
999.200.04	6.0	2.5	999.200.10	9.0	2.5
999.200.05	6.5	2.5	999.200.11	9.5	2.5
999.200.06	7.0	2.5	999.200.12	10.0	2.5

Refills- **\$5.00 ea 3@ \$4.75 ea**



Stainless Steel Waterproof Long Post 2.5 999.201

2.5 Tube, Tap 10. 24 pieces.

999.201 Assortment **\$43.95**

Number	Diam	Tube	Number	Diam	Tube
999.201.01	4.5	2.5	999.201.07	7.5	2.5
999.201.02	5.0	2.5	999.201.08	8.0	2.5
999.201.03	5.5	2.5	999.201.09	8.5	2.5
999.201.04	6.0	2.5	999.201.10	9.0	2.5
999.201.05	6.5	2.5	999.201.11	9.5	2.5
999.201.06	7.0	2.5	999.201.12	10.0	2.5

Refills- **\$5.00 ea 3@ \$4.75 ea**



Stainless Steel Waterproof Short Post 2.0 999.202

2.0 Tube, Tap 10. 24 pieces.

999.202 Assortment **\$43.95**

Number	Diam	Tube	Number	Diam	Tube
999.202.01	4.5	2.0	999.202.07	7.5	2.0
999.202.02	5.0	2.0	999.202.08	8.0	2.0
999.202.03	5.5	2.0	999.202.09	8.5	2.0
999.202.04	6.0	2.0	999.202.10	9.0	2.0
999.202.05	6.5	2.0	999.202.11	9.5	2.0
999.202.06	7.0	2.0	999.202.12	10.0	2.0

Refills- **\$5.00 ea 3@ \$4.75 ea**

Stainless Steel Waterproof Long Post 2.0 999.203

Stainless Steel, Tap 10. Two each of 12 sizes 4.5 - 10.0mm.

999.203 Assortment **\$43.95**

Number	Diam	Tube	Number	Diam	Tube
999.203.01	4.5	2.0	999.203.07	7.5	2.0
999.203.02	5.0	2.0	999.203.08	8.0	2.0
999.203.03	5.5	2.0	999.203.09	8.5	2.0
999.203.04	6.0	2.0	999.203.10	9.0	2.0
999.203.05	6.5	2.0	999.203.11	9.5	2.0
999.203.06	7.0	2.0	999.203.12	10.0	2.0

Refills- **\$5.00 ea 3@ \$4.75 ea**

Millimeter/Tap Conversion

0.60mm Tap 13	1.00mm Tap 9	1.60mm Tap 3
0.70mm Tap 12	1.10mm Tap 8	1.50mm Tap 4
0.80mm Tap 11	1.20mm Tap 7	1.70mm Tap 2
0.90mm Tap 10	1.30mm Tap 6	1.80mm Tap 1

CROWN ASSORTMENTS - WATERPROOF

Stainless Steel Waterproof Short/Flush Post 999.204

1.6 & 1.8 tubes, Tap 10. 01 and 07 flush post; 02-06 and 08-12 short post. 24 pieces.

999.204 Assortment \$43.95

Number	Diam	Tube	Number	Diam	Tube
999.204.01	3.0	1.6	999.204.07	3.0	1.8
999.204.02	3.5	1.6	999.204.08	3.5	1.8
999.204.03	4.0	1.6	999.204.09	4.0	1.8
999.204.04	4.5	1.6	999.204.10	4.5	1.8
999.204.05	5.0	1.6	999.204.11	5.0	1.8
999.204.06	5.5	1.6	999.204.12	5.5	1.8

Refills- \$5.00 ea 3@\$4.75 ea



Yellow Stainless Waterproof Long Post 999.207

Yellow plated stainless, 1.6-1.8 Tube, Tap 10. 24 pcs.

999.207 Assortment \$69.95

Number	Diam	Tube	Number	Diam	Tube
999.207.01	3.0	1.6	999.207.07	3.0	1.8
999.207.02	3.5	1.6	999.207.08	3.5	1.8
999.207.03	4.0	1.6	999.207.09	4.0	1.8
999.207.04	4.5	1.6	999.207.10	4.5	1.8
999.207.05	5.0	1.6	999.207.11	5.0	1.8
999.207.06	5.5	1.6	999.207.12	5.5	1.8

Refills- \$6.00 ea 3@\$5.50ea



Stainless Steel Waterproof Long Post 999.205

1.6 & 1.8 tubes, Tap 10. 24 pieces.

999.205 Assortment \$43.95

Number	Diam	Tube	Number	Diam	Tube
999.205.01	3.0	1.6	999.205.07	3.0	1.8
999.205.02	3.5	1.6	999.205.08	3.5	1.8
999.205.03	4.0	1.6	999.205.09	4.0	1.8
999.205.04	4.5	1.6	999.205.10	4.5	1.8
999.205.05	5.0	1.6	999.205.11	5.0	1.8
999.205.06	5.5	1.6	999.205.12	5.5	1.8

Refills- \$5.00 ea 3@\$4.75 ea



Stainless Steel Waterproof Long Post 2.0 999.214

Stainless Steel, Tap 10. 24 pieces total, 4 each of 6 sizes 3.0 - 5.5mm.

999.214 Assortment \$43.95

Number	Diam	Tube	Number	Diam	Tube
999.214.01	3.0	2.0	999.214.04	4.5	2.0
999.214.02	3.5	2.0	999.214.05	5.0	2.0
999.214.03	4.0	2.0	999.214.06	5.5	2.0

Refills- \$5.00 ea 3@\$4.75 ea



Yellow Stainless Waterproof Short/Flush Post 999.206

Yellow plated stainless, 1.6/1.8 Tube, Tap 10. Numbers 01 and 07 flush post; 02-06 and 08-12 short post. 24 pieces.

999.206 Assortment \$69.95

Number	Diam	Tube	Number	Diam	Tube
999.206.01	3.0	1.6	999.206.07	3.0	1.8
999.206.02	3.5	1.6	999.206.08	3.5	1.8
999.206.03	4.0	1.6	999.206.09	4.0	1.8
999.206.04	4.5	1.6	999.206.10	4.5	1.8
999.206.05	5.0	1.6	999.206.11	5.0	1.8
999.206.06	5.5	1.6	999.206.12	5.5	1.8

Refills - \$6.00 ea 3@\$5.50ea



Yellow Stainless Waterproof Long Post 999.215

Yellow plated stainless, 2.0 Tube, 3.0-5.5mm, Tap 10. 24 pcs, 4 each of 6 sizes.

999.215 Assortment \$69.95

Number	Diam	Tube
999.215.01	3.0	2.0
999.215.02	3.5	2.0
999.215.03	4.0	2.0
999.215.04	4.5	2.0
999.215.05	5.0	2.0
999.215.06	5.5	2.0

Refills-\$6.00 ea 3@\$5.50ea

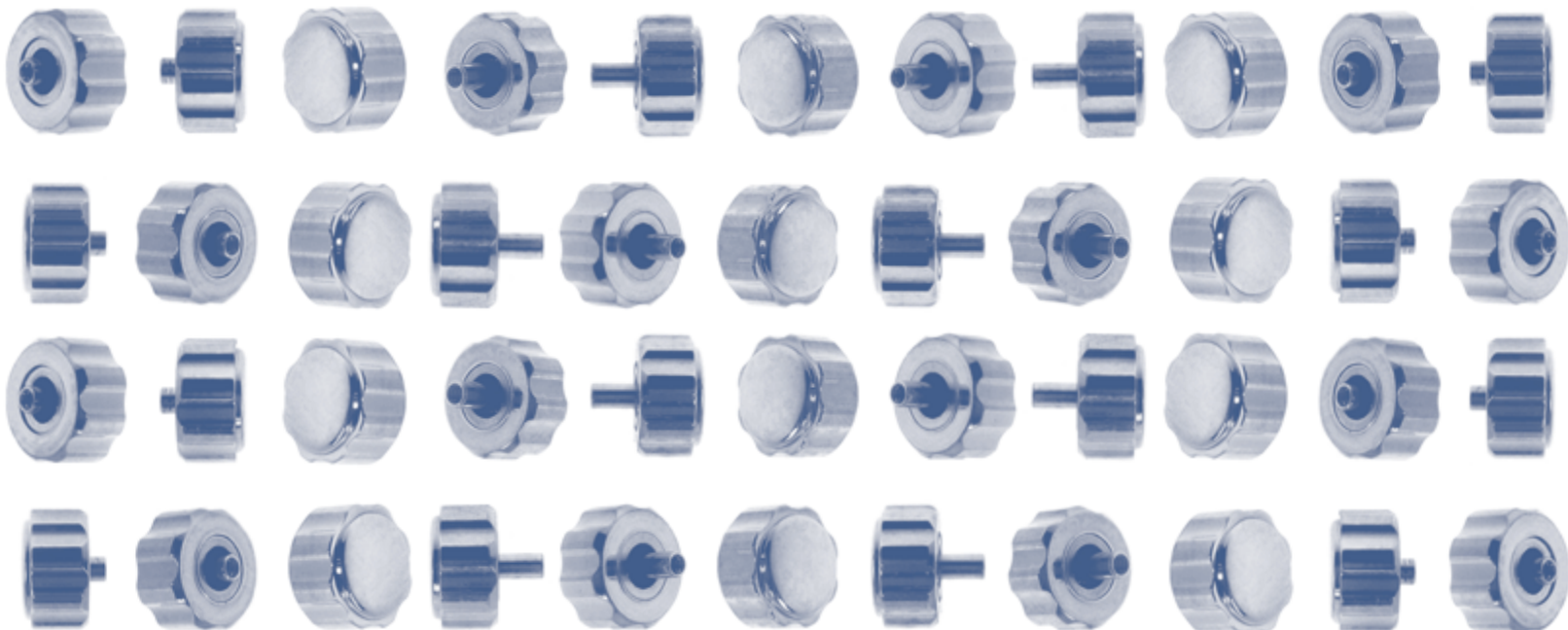

Dustproof Crowns 900.006

48 spring style dustproof crowns for Swiss and American Watches. New modern heavy knurl for easy winding. Contains 2 each Yellow and White.



900.006 Assortment		\$79.95		
Yellow	White	Diam.	Hght.	Tap
900.006.01	900.006.13	4.10	2.30	10
900.006.02	900.006.14	4.50	2.30	10
900.006.03	900.006.15	5.00	2.30	10
900.006.04	900.006.16	5.00	2.30	9
900.006.05	900.006.17	5.50	2.50	10
900.006.06	900.006.18	5.50	2.50	9
900.006.07	900.006.19	5.50	2.50	8
900.006.08	900.006.20	5.50	2.50	7
900.006.09	900.006.21	6.00	2.60	10
900.006.10	900.006.22	6.00	2.60	9
900.006.11	900.006.23	6.00	2.60	8
900.006.12	900.006.24	6.00	2.60	7

Refills-\$4.50ea 3@\$4.25 ea

Long Post Dustproof Crowns 900.026

Refills only - Limited Supply.



White SKU	Yellow SKU	Diam	Tap
900.026.04	900.026.01	2.75	10
900.026.05	900.026.02	2.75	11
900.026.06	900.026.03	2.75	12
900.026.10	900.026.07	3.00	10
900.026.11	900.026.08	3.00	11
900.026.12	900.026.09	3.00	12
900.026.16	900.026.13	3.25	10
900.026.17	900.026.14	3.25	11
900.026.18	900.026.15	3.25	12
900.026.22	900.026.19	3.50	10
900.026.23	900.026.20	3.50	11
900.026.24	900.026.21	3.50	12

Refills-Ltd Supply \$4.25ea 3@\$4.00ea

Bergeon Dustproof Crowns 906.613

Refills only - Limited Supply.



White	Yellow	Diam.	Tap	Thread
906.613.01	906.613.01Y	2.50	12	0.70
906.613.02	906.613.02Y	2.50	11	0.80
906.613.03	906.613.03Y	2.50	10	0.90
906.613.04	906.613.04Y	2.80	12	0.70
906.613.05	906.613.05Y	2.80	11	0.80
906.613.06		2.80	10	0.90
906.613.07	Use 900.090.04W-Y			
906.613.08	Use 900.090.03W-Y			
906.613.09	Use 900.090.02W-Y			
906.613.10	Use 900.090.10W-Y			

906.613.11 Use 900.090.09W-Y

906.613.12 Use 900.090.08W-Y

Refills-Ltd Supply \$5.50ea 3@\$4.75 ea

Dustproof Crowns 900.090

Assortment contains 1 yellow and 1 white of 12 sizes dustproof crowns, 24 pcs total.



900.090 Assortment \$47.95

Number	O.D.	Tap	Post
900.090.01	2.80	13	0.50
900.090.02	3.00	10	0.50
900.090.03	3.00	11	0.50
900.090.04	3.00	12	0.50
900.090.05	3.00	10	1.25
900.090.06	3.00	11	1.25
900.090.07	3.00	12	1.25
900.090.08	3.50	10	0.65
900.090.09	3.50	11	0.65
900.090.10	3.50	12	0.65
900.090.11	4.00	10	0.65
900.090.12	4.00	11	0.65

Refills- \$4.25ea 3@\$4.00ea

Additional Refill Sizes available:

Number	O.D.	Tap
900.090.13	4.00	12
900.090.14	2.75	13 White Only
900.090.15	3.00	13
900.090.16	3.50	13
900.090.17	4.00	13
900.090.18	4.00 thin	10

Additional Sizes- \$4.25ea 3@\$4.00ea

Dustproof Quartz Crowns 930.057

Refills only - Limited Supply.



Number	Color	Diam.	Tap
930.057.01	Yellow & White	2.50	11
930.057.02	White only	2.50	10
930.057.03	Yellow & White	2.80	12
930.057.04	Yellow & White	2.80	10
930.057.05	Use 900.090.04W-Y		
930.057.06	Use 900.090.05W-Y		
930.057.07	Use 900.090.10W-Y		
930.057.08	Use 900.090.08W-Y		
930.057.09	Yellow & White	4.00	12
930.057.10	Use 900.090.11W-Y		

Refills-Ltd Supply \$4.25 ea 3@\$4.00ea

Call Monday - Thursday 8:30 AM - 5:30 PM EST (6PM CST, 5PM MST, 4PM PST);

Friday 8:00AM - 5:00PM EST (4PM CST, 3PM MST, 2PM PST)

Call by 3:00PM Your Local Time (Mon-Thurs) for Overnight Delivery

1-800-487-0408

Please order all assortments and refills by SKU number. Thank you!

CROWN ASSORTMENTS - SCREW-DOWN

Screw-Down Crowns 999.011

12 Crowns, 1 each, all Tap 10. Yellow and White. Tubes & Gaskets included. Swiss. (Drive is mm diameter of case opening.)

999.011 Assortment \$249.95

Special Order - 2 to 4 months delivery

Number	Color	Style	Diam	Thrd	Drv
C60.002	Yellow		4.00	3.00	2.00
C60.003	Yellow	Antique	4.00	3.00	2.00
C60.004	Yellow		4.50	4.40	2.00
C60.016	Yellow		6.00	3.00	2.90
C60.022	Yellow		3.50	3.00	1.90
C60.505	White	Antique	4.50	3.00	2.00
C60.502	White		4.00	3.00	2.00
C60.503	White	Antique	4.00	3.00	2.00
C60.504	White		4.50	3.00	2.00
C60.516	White		6.00	4.40	2.90
C60.522	White		3.50	3.00	1.90
C60.506	White		5.00	3.00	2.20

Refills from \$28.95 to \$39.95 - call for price



Screw-Down Crowns to fit Imitation RLX 900.008

Contains 2 each yellow and 1 each white in each size. All Tap 10. 9 total, crowns with friction fit tubes.

900.008 Assortment \$24.95

White	Yellow	Diam.	Tube	Thrd
900.008.01	900.008.04	4.50	2.50	3.40
900.008.02	900.008.05	5.50	2.50	3.40
900.008.03	900.008.06	6.00	2.50	3.40

Refills- **\$5.00ea 3@\$4.00ea**



Screw-Down Crowns 999.012

12 Crowns, 1 each, all Tap 10. Yellow and White. Tubes & gaskets included. Swiss made.

(Drive is mm diameter of case opening.)

999.012 Assortment \$249.95

Special Order - 2 to 4 months delivery

White	Yellow	Diam.	Thread	Drive
C60.502	C60.002	4.00	3.00	2.00
C60.526	C60.026	4.50	3.00	2.50
C60.514	C60.014	5.00	3.00	2.50
C60.510	C60.010	6.00	4.40	2.50
C60.515	C60.015	5.30	4.00	2.80
C60.516		6.00	3.00	2.90
	C60.016	6.00	4.40	2.90

Refills from \$28.95 to \$39.95 - call for price



Swiss Made Screw-Down Crowns 999.187 999.189

999.187 crown assortments in all yellow, 2 each of 10 sizes with tubes. all Tap 10.

999.189 crown assortments in 1 white 1 yellow of 10 sizes with tubes, all Tap 10. Refills only for white.

(Drive is mm diameter of case opening.)

999.187 Yellow Assortment \$89.95

999.189 White & Yellow Asst \$89.95

Number	Color	O.D.	Thread	Drive
C60.826	Yellow	4.50	3.50	2.50
C60.825	Yellow	4.75	3.50	2.50
C60.860	Yellow	5.50	3.50	2.50
C60.810	Yellow	6.00	3.50	2.50
C60.864	Yellow	7.00	4.50	2.30
C60.845	Yellow	4.75	4.00	2.50
C60.828	Yellow	6.00	4.00	2.70
C60.861	Yellow	6.50	4.00	2.70
C60.862	Yellow	7.00	4.00	2.70
C60.863	Yellow	7.00	4.50	2.70

Also available, white refills only:

Number	Color	O.D.	Thread	Drive
C60.926	White	4.50	3.50	2.50
C60.925	White	4.75	3.50	2.50
C60.960	White	5.50	3.50	2.50
C60.910	White	6.00	3.50	2.50
C60.964	White	7.00	4.50	2.30
C60.945	White	4.75	4.00	2.50
C60.928	White	6.00	4.00	2.70
C60.961	White	6.50	4.00	2.70
C60.962	White	7.00	4.00	2.70
C60.963	White	7.00	4.50	2.70

Refills **\$17.95 ea**



Screw-Down Crowns 999.073

12 Crowns, 1 each, all Tap 10. Yellow, White and Black, inside screwing. Tubes included. Swiss made.

(Drive is mm diameter of case opening.)

999.073 Assortment \$249.95

Special Order - 2 to 4 months delivery

Number	Color	Diam.	Drive	Tube
C60.011	Yellow	5.00	2.50	3.00
C60.012	Yellow	5.50	2.50	3.00
C60.023	Yellow	5.00	1.80	2.60
C60.024	Yellow	4.50	1.80	2.60
C60.343	Black	6.00	2.50	3.15
C60.344	Black	5.00	2.00	3.00
C60.511	White	5.00	2.50	3.00
C60.512	White	5.50	2.50	3.00
C60.520	White	6.00	2.50	3.15
C60.521	White	6.50	2.50	3.15
C60.523	White	5.00	1.80	2.60
C60.524	White	4.50	1.80	2.60

Refills from \$28.95 to \$39.95 - call for price



Genuine Seiko Crowns
900.052

52 Seiko Crowns, 2 each of 24 yellow and 1 each of 4 white for Hattori brands Seiko, Pulsar, and Lorus.

900.052 Assortment \$99.95



Btl. Crown	Color	Btl. Crown	Color
1 30MA2NA1	Y	13 35MX7NN1	Y
2 30M98NA1	Y	14 35M68NA1	Y
3 32M29NA1	Y	15 35M82NA1	Y
4 32M63NN1	Y	15 35M82NS1	W
5 32N23NA1	Y	16 35R34NA1	Y
5 32N23NS1	W	17 40MH1NA1	Y
6 35D03NA1	Y	18 45M74NA1	Y
7 35E09NN1	Y	19 6M30B9NNG1	Y
8 35ME9NA1	Y	20 8M30A0NNG1	Y
9 35MP0NF1	Y	21 8M35A0NNG2	Y
10 35MR8NF1	Y	21 8M35A0SNW1	W
11 35MS4NF1	Y	22 8M35A7NNG0	Y
12 35MX2NF1	Y	23 8M35B4NNG1	Y
12 35MX2NS1	W	24 8M40A0NNG1	Y

OVER \$300 VALUE
if purchased separately!

Refills- \$5.95 to \$6.95 each.
Order by Seiko Crown Number.

Genuine Seiko Crowns Yellow
900.098

12 Genuine Seiko Crowns, All Yellow.
Includes 1 of each number.

900.098 Assortment \$42.95



32M29NA1	35MR8NF1	35R34NA1
35E09NN1	35M68NA1	8M35A0NNG1
35ME9NA1	35M82NA1	8M35A0NNG2
35MP0NF1	30M98NA1	8M40A0NNG1

Refills- \$5.95 to \$6.95 each.
Order by Seiko Numbers

A VALUE OF OVER \$70 IF PURCHASED SEPARATELY!

Genuine Seiko Crowns Yellow
999.634

24 pieces, 2 each of 12 numbers all yellow.

999.634 Assortment \$41.95



32M29NN1	35M81NN1
35M82NA1	35ME9NN1
35MR6NF1	35MR8NF1
40MK1NN1	40ML9NN1
32M01NN1	8M35A0NNG1
8M40A0NNG3	8M35A7NNG0

Refills- \$5.95 to \$6.95 each.
Order by Seiko Numbers

A VALUE OF OVER \$140 IF PURCHASED SEPARATELY!

Genuine Seiko Crowns White
999.635

24 pieces, 2 each of 12 numbers All white.

999.635 Assortment \$54.95



30M22NS1	32M29NS1	35M82NS1
35M94NS1	35M98NS1	35ME9NS1
35MR8NS1	40M58NS1	40MC5NS1
40MK1NS1	40ML9NS1	
8M40A0SNW1		

Refills- \$5.95 to \$6.95 each.
Order by Seiko Numbers

A VALUE OF OVER \$140 IF PURCHASED SEPARATELY!

Generic Seiko Crowns
900.095

27 generic crowns for Seiko. Includes 1 of each number.

900.095 Assortment \$64.95



Number	Seiko No.	Color
900.095.01	30M08NA1	Yellow
900.095.02	30M22NA1	Yellow
900.095.03	30M98NA1	Yellow
900.095.04	32M29NA1	Yellow
900.095.05	32M29NS1	White
900.095.06	32N23NA1	Yellow
900.095.07	35D03NN1	Yellow
900.095.08	35E09NS1	White
900.095.09	35E09NN1	Yellow
900.095.10	35ME9NN1	Yellow
900.095.11	35MR6NF1	Yellow
900.095.12	35MR8NF1	Yellow
900.095.13	35MS4NA1	Yellow
900.095.14	35MU6NF1	Yellow
900.095.15	35M68NS1	White
900.095.16	35M68NA1	Yellow
900.095.17	35M81NN1	Yellow
900.095.18	35M82NA1	Yellow
900.095.19	35M82NS1	White
900.095.20	35M94NA1	Yellow
900.095.21	35M90NA1	Yellow
900.095.22	35M97NN1	Yellow
900.095.23	35M98NA1	Yellow
900.095.24	35M98NS1	White
900.095.25	40M58NA1	Yellow
900.095.26	40M76NA1	Yellow
900.095.27	45M30NA1	Yellow

Refills- **\$4.25ea**

Genuine Citizen Crowns
999.633

24-pcs, two each of 12 numbers for Citizen watches, yellow & white.

999.633 Assortment \$69.95



506-B782B	Yellow	506-D502B	Yellow
506-2614	Yellow	506-2254	Yellow
506-2524	Yellow	506-2884	Yellow
506-2104J	Yellow	506-4494	Yellow
506-3814	Yellow	506-2251	White
506-2881	White	506-2101	White

Refills - **\$12.00 each**

Order by Citizen Numbers

\$288 VALUE
if purchased separately!

CROWN ASSORTMENTS - GENUINE/GENERIC, POCKET WATCH

**Generic Crowns
to fit Rolex
999.129**

A \$211.80
VALUE FOR
**JUST
\$99!**



2 each (8 total) Yellow and White
Stainless Steel Crowns, sizes 5.30 and
6.00. Also includes Case Tubes to
fit Rolex, 2 each size. **Crowns Value
\$180.00, Tubes Value \$31.80**

999.129 Assortment \$99.00

Number	Description	Color	Diam.
902.294	Crown	Yellow	5.30
902.295	Crown	White	5.30
902.296	Crown	Yellow	6.00
902.297	Crown	White	6.00
R5.3	Case Tube w/Gasket		5.30
R6.0	Case Tube w/Gasket		6.00

Refills Crowns- **\$22.50 ea**
Refills Case Tubes- **\$7.95 ea**

Also available, not in assortment:

Number	Description	Color	Diam.	Price
902.298	Crown	Yellow	7.00	\$40.00
902.299	Crown	White	7.00	\$40.00
R7030	Case Tube w/Gasket		7.00	\$24.00
R530C	Crown Gasket		5.30	\$2.00
R600C	Crown Gasket		6.00	\$2.00
R530T	Tube Gasket		5.30	\$2.00
R600T	Tube Gasket		6.00	\$2.00

**Crowns for Orient
999.112**



Yellow & White 24 piece assortment
contains 2 each of 12 crowns for Orient
cases.

999.112 Assortment \$34.95

38.0147	Yellow	38.0149	Yellow
38.0153	Yellow	38.0154	Yellow
38.0209	Yellow	38.0211	Yellow
38.0224	Yellow	38.0225	Yellow
38.0105	Yellow	38.0223	Yellow
38.0064	White	38.0075	White

No Refills available.

**Swiss Crowns for
Cartier Watches
999.135**



Six crowns (2 yellow and 4 white with
blue 7 sides and black stones), 2 tubes
with gaskets, and 2 tube gaskets, all to
fit Cartier.

999.135 Assortment \$218.00

Number	Color	Stone	Diam.	\$Each
C83.403	White	Blue	4.25	\$39.50
C83.401	White	Black	4.35	\$39.50
C83.451	Yellow	Black	4.35	\$39.50
C83.402	White	Black	4.45	\$39.50
C83.452	Yellow	Black	4.45	\$39.50
C83.404	White	Blue	4.75	\$39.50
C47.101	Tube with Gasket			\$19.95
C43.006	Tube Gasket			\$7.95

Special Order - 2 to 4 months delivery
Limited Refills - Order by Part Number.

**Pocket Watch
Pusher Crown
C63.87800**

Pusher Style Round Yellow
9.5 O.D. 5.0 Opening Tap 10
C63.87800 \$6.95



**Pocket Watch
Pusher Crowns
900.030**

20 Pusher Crowns, 2 each size, for
Modern Arnex and other Pocket
Watches.

900.030 Assortment \$92.95

Number	Color	Style	Diam.	Tap
900.030.01Y	Yellow	Flat	3.90	10
900.030.02Y	Yellow	Flat	4.40	10
900.030.03Y	Yellow	Flat	5.00	10
900.030.04Y	Yellow	Antique	4.50	10
900.030.05Y	Yellow	Antique	5.30	10
900.030.06Y	Yellow	Antique	6.30	10
900.030.07Y	Yellow	Antique	7.20	10
900.030.08Y	Yellow	Antique	8.40	10
900.030.09Y	Yellow	Antique	8.40	6
900.030.10W	White	Antique	8.40	6

Also available, not in assortment:

900.030.01W	White	Flat	3.90	10
900.030.02W	White	Flat	4.40	10
900.030.03W	White	Flat	5.00	10
900.030.04W	White	Antique	4.50	10
900.030.05W	White	Antique	5.30	10
900.030.06W	White	Antique	6.30	10
900.030.07W	White	Antique	7.20	10
900.030.08W	White	Antique	8.40	10

Refills **\$8.95ea 3@\$8.50ea 6@\$7.95ea**

**Pocket Watch
Crowns**

**999.015
999.016**

24 piece assortment, 2 each of 12
sizes all Yellow or all White. Swiss made.

999.015 White Assortment \$82.95

999.016 Yellow Assortment \$84.95



Yellow	White	Head Diam.	Open	Tap
C63.052	C63.552	4.50	2.80	10
C63.053	C63.553	4.50	3.00	10
C63.002	C63.502	5.00	3.00	10
C63.054	C63.554	5.00	2.80	10
C63.003	C63.503	6.00	3.30	10
C63.004	C63.504	6.50	3.50	10
C63.057	C63.557	7.00	3.05	10
C63.005	C63.505	7.25	4.00	10
C63.005/120	C63.505/120	7.25	4.00	6
C63.006	C63.506	8.25	4.20	10
C63.006/120	C63.506/120	8.25	4.20	6
C63.059	C63.559	9.00	4.60	10

Also available, not in assortment:

C63.001	C63.501	4.00	2.30	.90
C63.050	C63.550	3.75	2.20	.90
C63.051	C63.551	4.00	2.80	.90
C63.055		6.00	2.50	.90
	C63.558	8.00	4.00	7
	C63.87800			10

Refills - Order by Crown Number
\$6.50ea 3@\$5.00ea 6@\$4.00ea

See page 368 for additional pocket watch parts.

Crown Tools PAGE 101

Jeweled Crowns Yellow Assortment 909.068

20 Yellow Crowns, 2 each size, for new watches. Includes Red, Blue and Black stones, Waterproof and Dustproof styles.

909.068 Assortment **\$54.95**

No Refills Available.



Jeweled Crowns 999.067 Refills Only

Individual jeweled waterproof and dustproof crowns. Available with black, blue, or red stones. Refills only.

Individual Jeweled Crown - order by SKU

\$6.00ea 3@**\$5.00 ea** 6@**\$4.00ea**

Number	Clr.	Stone	Type	Diam.	Tube	Tap	Number	Clr.	Stone	Type	Diam.	Tube	Tap
999.067.01	Y	Blue	DP	3.50		10	999.067.23	W	Blue	WP	4.00	2.00	10
999.067.02	Y	Black	DP	3.50		10	999.067.24	W	Black	WP	4.00	2.00	10
999.067.03	W	Blue	DP	3.50		10	999.067.25	Y	Blue	WP	3.50	2.00	10
999.067.04	W	Black	DP	3.50		10	999.067.26	Y	Black	WP	3.50	2.00	10
999.067.05	Y	Blue	DP	4.00		10	999.067.27	W	Blue	WP	3.50	2.00	10
999.067.06	Y	Black	DP	4.00		10	999.067.28	W	Black	WP	3.50	2.00	10
999.067.07	W	Blue	DP	4.00		10	999.067.29	Y	Blue	WP	3.00	1.80	10
999.067.08	W	Black	DP	4.00		10	999.067.30	Y	Black	WP	3.00	1.80	10
999.067.09	Y	Blue	DP	3.00		10	999.067.31	W	Blue	WP	3.00	1.80	10
999.067.10	Y	Black	DP	3.00		10	999.067.32	W	Black	WP	3.00	1.80	10
999.067.11	W	Blue	DP	3.00		10	999.067.33	Y	Blue	WP	3.00	1.60	10
999.067.12	W	Black	DP	3.00		10	999.067.34	Y	Black	WP	3.00	1.60	10
999.067.13	Y	Blue	DP	3.00		11	999.067.35	W	Blue	WP	3.00	1.60	10
999.067.14	Y	Black	DP	3.00		11	999.067.36	W	Black	WP	3.00	1.60	10
999.067.15	W	Blue	DP	3.00		11	999.067.37	Y	Blue	WP	3.00	1.60	11
999.067.16	W	Black	DP	3.00		11	999.067.38	Y	Black	WP	3.00	1.60	11
999.067.17	Y	Blue	DP	3.00		12	999.067.39	W	Blue	WP	3.00	1.60	11
999.067.18	Y	Black	DP	3.00		12	999.067.40	W	Black	WP	3.00	1.60	11
999.067.19	W	Blue	DP	3.00		12	999.067.41	W	Red	DP	3.75		10
999.067.20	W	Black	DP	3.00		12	999.067.42	Y	Red	DP	3.75		10
999.067.21	Y	Blue	WP	4.00	2.00	10	999.067.43	W	Blue	WP	3X	1.60	12
999.067.22	Y	Black	WP	4.00	2.00	10	999.067.44	Y	Blue	WP	3X	1.60	12

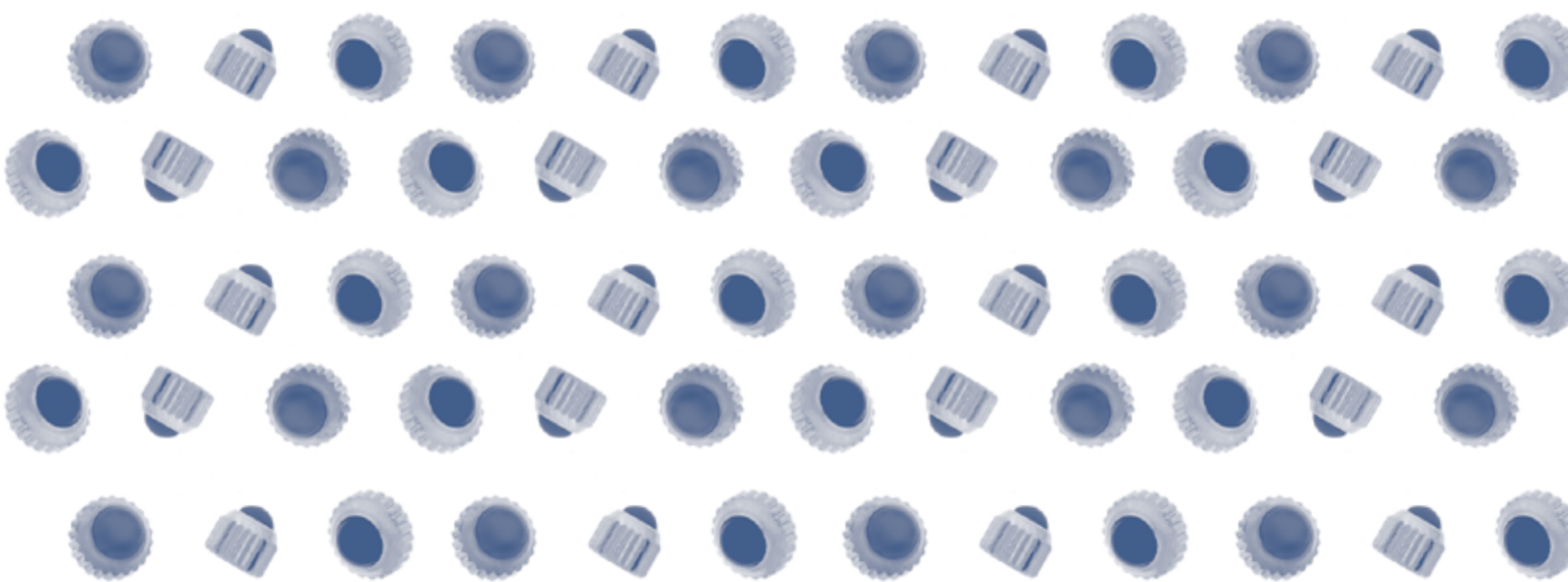

PUSH BUTTON ASSORTMENTS

Chronograph Pushers to fit Tag Heuer 999.113

*mm Sizes:
Diameter x Thread x Height*



Chronograph Pushers 901.060



10 screw down pushers (1 each yellow and white of 5 sizes). 40 assorted axles. 2.00mm stem length. Swiss. **Special Order only.**

901.060 Assortment \$199.00
Special Order Only, 2-4 Months Delivery

Number	Color	Diam.	Thread
901.060.101W	White	4.00	2.54
901.060.101Y	Yellow	4.00	2.54
901.060.102W	White	4.40	2.54
901.060.102Y	Yellow	4.40	2.54
901.060.103W	White	5.00	2.54
901.060.103Y	Yellow	5.00	2.54
901.060.104W	White	4.40	2.75
901.060.104Y	Yellow	4.40	2.75
901.060.105W	White	5.00	2.75
901.060.105Y	Yellow	5.00	2.75

Refills - **\$28.95 ea**

Yellow Flower Head

910.619



All Yellow 2 ea. of 12 sizes.

910.619 Assortment \$36.95

No Refills available.

White Flower Head

910.620



All White 2 ea. of 12 sizes.

910.620 Assortment \$36.95

No Refills available.

Flat Head

910.621



Yellow & White. 3 each of 9 sizes. 54 total.

910.621 Assortment \$31.95

No Refills available.

White Round Head

910.622



All White. 3 each of 13 sizes. 39 total.

910.622 Assortment \$26.95

No Refills available.

Yellow Round Head

910.623



All Yellow. 3 each of 13 sizes. 39 total.

910.623 Assortment \$26.95

No Refills available.

"E" Clips Assortment - 906.031

10 each of 6 sizes (60 pieces total).

906.031 Assortment \$10.95



Pusher "C" & "E" Clips for Digital Watches

914.035

Assortment of 120 clips for pushers. Five sizes: 1.5, 1.8, 2.0, 3.0 and 4.0. Swiss.

914.035 Assortment \$26.95 No Refills available.



"C" Clips for Seiko & Citizen Buttons

999.143

Assortment of 80 clips for pushers.

Seiko 81400669, 83200241, 83200241, 83200273.

Citizen 390.0068, 390.0062, 390.0069, 390.004.

999.143 Assortment \$99.95 - Refills - Order by Part Number.



OVER \$200 VALUE for just \$59.95!



Master Stem Assortment 999.401

48-piece assortment, 2 each of 24 of our most popular stems for Quartz that interchange with Citizen/Miyota, ETA, Orient, and Seiko/Pulsar/Phasar/Lorus.
999.401 Assortment \$59.95

Stem #	Interchangeability
CITIZEN/MIYOTA	
065-299	2001A 2005 2015 2025 2030 2035 2036 2105 2115 2117 2305 2315 2350 2353
065-379	C480 T480 7W71 6R29 5500 5510 6000/6100/6L00/6M00/6N00/6P00 Series
065-403	5920 5930 5Y20 5Y30
065-413	5420 5421 5422 5432 5R20 5R21 5R22 5R32
065-501	2500 2510 2560 2565
065-505	1L12 1L15 1L50 1L60 1M01 1M12 1M15 1M50 1N12 1S02 1S13 1102
ETA/ESA	
401-906	555.111 to 555.425 556.031 to 556.415 955.111 to 955.425 956.031 to 956.612
401-955	578.004 976.001 978.002 979.001
401-1370	400.111/411 803.111/114 804.111/114/191 805.111/114/161/121/124/144
401-1519	F05.111 F06.111 F06.161 F07.111
401-1520	F03.111 F04.111
RONDA	
401-1233	702, 703, 705, 706, 708, 713, 715, 773, 775, 785, 788
401-1237	751E, 752, 753, 762, 763
401-1483	505 to 519
SEIKO/PULSAR/PHASAR/LORUS/HATTORI	
351177 T10	AL82/83 VD53/57/58/59/78/85/86 VT82/83/89 VS32/82 VX12/19/3K/32/33/36/42/43/44/82/83/89 7N29/32/42/43 V722/729
351207 T13	2E20 2E50 2E70 VB20B
351206	
351205	
351208 T11	Same as 351207
351332	VJ12 VJ22 VJ23 VJ24 VJ32 VJ33 VJ34
351546	3E22 3E23 3Y02 3Y03
351653	5M22 5M23 5M42 5M43 5M62 5M63
351651	
351807 T13	IF20 IN00 IN01 YL60 YL61 Y150 VS10 VX00 VX01 VX10 VX11 Bul. 666.10
351819 T10	Same as 351807
351890	7N00 7N01 V700 V701 VP01 VT07
351892 T11	Same as 35117

Order Refills by Stem Part Number.
 Refills \$3.95 to \$5.50 - call for current price.

Miyota/Citizen Stems 999.662

Original Miyota stems for Miyota movements. Assortment contains 48 pieces, 24 sizes.

999.662 Assortment \$49.95

STEM #	SIZE	FITS
065-441	15.8mm	OSXX
065-453	18.8mm	OSXX
065-477		1L2X; 1L3X; 1L4X
065-505		1LXX; 1MXX; 1SXX; JRXX; JSXX
065-299		2039; 20X5; 21X5; 23X5; 24X5; 235X
065-468		2025; 203X
065-501		25XX; 2F10; 2SXX
065-398		4S20
065-397		4TXX; 4UXX
065-413		5R21; 5R32
065-403		5Y20; 5Y30
065-387		6L71; 6L76
065-379		6NXX; 6PXX
065-426	24.0mm	6PXX
065-A13		6S10; 6S20; 6S30
065-434		7T35
065-212		8200; 8205; 8215
065-A05		90XX; 91XX
065-495		9TXX; 9UXX
065-549		FSXX
065-547		GL00; GL10; GN15
065-541		GL20; GL30
065-543		GM00; GM01; GM1X
065-992		GPXX

Order Refills by Stem Part Number. **\$5.00 each**

\$240 VALUE for just \$49.95!

Stems to fit Citizen 999.121



Contains 3 each of 12 numbers, 36 stems total.

999.121	Assortment	\$49.95
065-212	Fits 8205	
065-346	Fits 3S10, 3S31	
065-371	Fits 2015, 2025, 2035	
065-379	Fits 6L12/22/32/40, 6M12/42, 2105/2115, T480	
065-397	Fits 4U13/74, 4T13/48/74, 6P25/27/28/89	
065-403	Fits 5Y20, 5Y30	
065-419	Fits 6W40/50, 6W60/70, OW50	
065-441	Fits 0T10, 0S10/60, 3U60/62	
065-444	Fits CS00, T200/205, T240/250	
065-453	Fits OS10/60, BR10	
065-505	Fits 1S02, 1L12, 1M12	
065-527	Fits AS10	

Order Refills by Stem Part Number. **\$5.00 each**

\$180 VALUE JUST \$49.95!

CITIZEN SEIKO



STEM ASSORTMENTS

Stems to fit ISA

999.122



Assortment contains 3 each of 12 different numbers, 36 stems total.

999.122 Assortment **\$44.95**

Stem #	ISA #	Tap	Fits
401/1465	138	10	120/138
401/1465	138	10	120/138
401/1464	125	11	125/127
401/1377	125	10	125/127
401/1477	638	10	K62/K63
401/1463	125	12	125/127
401/1610	2331	10	2331/9232/9238
401/1354	307	10	307/317
401/1281	389	10	389
401/1493	8171	10	8161/8171/8172
401/1021	1198	10	1198
401/1475	8154	10	8154/8173/8174

Order Refills by Stem #. Refills \$5.00 to \$7.00 - call for price.

Stems to fit ETA

999.124



Assortment contains 3 each of 12 different numbers, 36 stems total.

999.124 Assortment **\$43.95**

Stem #	ETA #	Tap	Stem #	ETA #	Tap
401/1339	251.251	10	401/1369	901.001	10
401/1484	251.471	10	401/1372	902.101	10
401/1104	255.111	10	401/906	956.114	10
401/1099	256.111	10	401/955	978.001	10
401/1349	282.001	11	401/1280	980.001	10
401/1370	803.111	10	401/1497	G10.211	10

Order Refills by Stem #. Refills \$4.95 to \$7.00 - call for price.

Stems to fit ETA

999.125



Assortment contains 3 each of 18 different numbers, 54 stems total.

999.125 Assortment **\$43.95**

Stem #	ETA #	Tap	Stem #	ETA #	Tap
401/1156	210.001	11	401/1372	902.001	10
401/1339	251.252	10	401/906	956.112	10
401/1484	251.471	10	401/955	976.001	10
401/1104	255.111	10	401/1280	980.003	10
401/1099	256.000	10	401/1520	F03.111	10
401/1155	280.002	11	401/1519	F05.111	10
401/1349	282.001	11	401/1497	G10.211	10
401/1370	803.111	10	401/729	2671	10
401/1369	901.001	10	401/1029	2801	10

Order Refills by Stem #. Refills \$4.95 to \$11.50 - call for price.

TAP/MM CONVERSION

Tap 3 = 1.60 mm	Tap 8 = 1.10 mm
Tap 4 = 1.50 mm	Tap 9 = 1.00 mm
Tap 5 = 1.40 mm	Tap 11 = 0.80 mm
Tap 6 = 1.30 mm	Tap 12 = 0.70 mm
Tap 7 = 1.20 mm	Tap 13 = 0.60 mm



Stem Extenders

900.060



60 Swiss Made Stem Extenders in 12 bottles.

900.060 Assortment **\$42.95**

Refill Number	Thread Inner x Outer	Refill Number	Thread Inner x Outer
900.060.01	0.60 x 0.60	900.060.07	1.20 x 1.20
900.060.02	0.70 x 0.70	900.060.08	0.70 x 0.90
900.060.03	0.80 x 0.80	900.060.09	0.90 x 0.70
900.060.04	0.90 x 0.90	900.060.10	0.90 x 0.80
900.060.05	1.00 x 1.00	900.060.11	0.90 x 1.20
900.060.06	1.10 x 1.10	900.060.12	1.20 x 0.90

Refills-

\$3.25 ea 3@\$2.75 ea 6@\$2.50 ea 12@\$2.00 ea

Stem Extenders

900.065



60 Swiss Made Stem Extenders in 12 bottles.

900.065 Assortment **\$42.95**

Refill Number	Thread Inner x Outer	Refill Number	Thread Inner x Outer
900.065.01	0.50 x 0.50	900.065.07	1.00 x 0.90
900.065.02	0.50 x 0.70	900.065.08	1.10 x 0.90
900.065.03	0.50 x 0.90	900.065.09	1.30 x 0.90
900.065.04	0.60 x 0.90	900.065.10	1.30 x 1.30
900.065.05	0.80 x 0.90	900.065.11	1.40 x 0.90
900.065.06	0.90 x 1.00	900.065.12	1.40 x 1.40

Refills-

\$3.25 ea 3@\$2.75 ea 6@\$2.50 ea 12@\$2.00 ea

Male/Female Crown Posts & Converter

900.059



Female Crown Post Male Crown Post Converter

Available individually only.

900.059.01	Tap 11	Female	Post
900.059.02	Tap 10	Female	Post
900.059.03	Tap 9	Female	Post
900.059.04	Tap 8	Female	Post
900.059.05	Tap 7	Female	Post
900.059.06	Tap 10	Male	Post
900.059.07	Tap 9	Male	Post
900.059.08	Tap 8	Male	Post
900.059.09	Tap 7	Male	Post
900.059.10	Tap 10	Female	Converter

Refills- \$7.50 ea 3@\$6.00 ea

Cas-Ker Master O-Ring Gasket Assortment

Three each of 151 sizes O-Ring gaskets, 453 total. See list below. Comes in deluxe hinged lid box.

Table with 4 columns: Number, MM Thickness, Inside Diameter, Outside Diameter. Lists 151 gasket sizes.

900.133 Master O-Ring Gasket Assortment \$54.95 Refills (pack of 3) 1pk@ \$1.95 3pks@ \$1.75ea 6pks@ \$1.50ea

Cas-Ker Thin O-Ring Gasket Assortment

Three each of 52 sizes O-Ring gaskets, 156 total. See list below. Comes in deluxe hinged lid box.

Table with 4 columns: Number, MM Thickness, Inside Diameter, Outside Diameter. Lists 52 gasket sizes.

900.136 Thin O-Ring Gasket Assortment \$34.95 Refills (pack of 3) 1pk@ \$1.95 3pks@ \$1.75ea 6pks@ \$1.50ea

Cas-Ker Large O-Ring Gasket Assortment

Three each of 63 larger sizes O-Ring gaskets, 168 total. See list below. Comes in deluxe hinged lid box.

Table with 4 columns: Number, MM Thickness, Inside Diameter, Outside Diameter. Lists 63 gasket sizes.

900.137 Large O-Ring Gasket Assortment \$37.95 Refills (pack of 3) 1pk@ \$1.95 3pks@ \$1.75ea 6pks@ \$1.50ea

GASKET ASSORTMENTS - CASE BACK

Silicone O-Ring Gaskets 900.139

72 piece assortment contains 3 each of 24 sizes.

900.139 Assortment \$38.95

Stock Number	MM Thick.	Inside Diam.	Outside Diam.	Stock Number	MM Thick.	Inside Diam.	Outside Diam.
S40.1500	.40	15.00	15.80	S50.2600	.50	26.00	27.00
S40.1600	.40	16.00	16.80	S50.2700	.50	27.00	28.00
S40.1700	.40	17.00	17.80	S50.2800	.50	28.00	29.00
S40.1800	.40	18.00	18.80	S50.2900	.50	29.00	30.00
S40.1900	.40	19.00	19.80	S50.3000	.50	30.00	31.00
S50.1500	.50	15.00	16.00	S60.1750	.60	17.50	18.70
S50.1650	.50	16.50	17.50	S60.2500	.60	25.00	26.20
S50.1750	.50	17.50	18.50	S60.2600	.60	26.00	27.20
S50.2000	.50	20.00	21.00	S60.2700	.60	27.00	28.20
S50.2200	.50	22.00	23.00	S60.2800	.60	28.00	29.20
S50.2400	.50	24.00	25.00	S60.2900	.60	29.00	30.20
S50.2500	.50	25.00	26.00	S60.3000	.60	30.00	31.20

Refills (pack of 3) -

1pk@ \$3.25 3pks@ \$2.95 ea 6pks@ \$2.50 ea

O-Ring Gasket Assortments 901.609.3 - .8

Assortments contain 144 O-Ring Gaskets each. Bulk - No Refills.

901.609.3	0.3mm Thick, 11.0 - 30.0 Diameters	\$12.95
901.609.4	0.4mm Thick, 8.00 - 30.5 Diameters	\$12.95
901.609.5	0.5mm Thick, 11.0 - 30.5 Diameters	\$12.95
901.609.6	0.6mm Thick, 13.0 - 33.0 Diameters	\$12.95
901.609.7	0.7mm Thick, 12.0 - 33.5 Diameters	\$12.95
901.609.8	0.8mm Thick, 15.0 - 39.0 Diameters	\$12.95

O-Ring Gaskets - Bulk

50 assorted sizes O-ring gaskets. Bulk. Swiss.

905.111	O-Ring Gaskets No Refills	\$16.95
905.112	O-Ring Gaskets for Quartz No Refills	\$16.95

Red Plastic Gaskets for Case Backs 903.090

1 each of 30 sizes.

903.090 Assortment \$42.95

Refills - **\$5.00 ea**

Number	Inside Diameter	Outside Diameter	Number	Inside Diameter	Outside Diameter
903.090.01	17.35	18.50	903.090.16	24.85	26.00
903.090.02	17.85	19.00	903.090.17	25.35	26.50
903.090.03	18.35	19.50	903.090.18	25.85	27.00
903.090.04	18.85	20.00	903.090.19	26.35	27.50
903.090.05	19.35	20.50	903.090.20	26.85	28.00
903.090.06	19.85	21.00	903.090.21	27.35	28.50
903.090.07	20.35	21.50	903.090.22	27.85	29.00
903.090.08	20.85	22.00	903.090.23	28.35	29.50
903.090.09	21.35	22.50	903.090.24	28.85	30.00
903.090.10	21.85	23.00	903.090.25	29.35	30.50
903.090.11	22.35	23.50	903.090.26	29.85	31.00
903.090.12	22.85	24.00	903.090.27	30.35	31.50
903.090.13	23.35	24.50	903.090.28	30.85	32.00
903.090.14	23.85	25.00	903.090.29	31.35	32.50
903.090.15	24.35	25.50	903.090.30	31.85	33.00

Genuine Bergeon Flat Rubber Gaskets 900.872

Flat Rubber Gaskets for Waterproof Watches. Bergeon #6630.

Refills Only.

Number	Diameter	Number	Diameter	Number	Diameter
900.872.01	15.0 x 17.0	900.872.11	24.0 x 25.5	900.872.23	29.0 x 30.0
900.872.02	17.0 x 18.0	900.872.12	23.5 x 25.5	900.872.24	28.5 x 30.4
900.872.03	17.8 x 18.7	900.872.13	24.0 x 26.0	900.872.25	29.0 x 30.5
900.872.04	18.5 x 19.5	900.872.14	25.5 x 26.5	900.872.26	28.75 x 30.75
900.872.05	19.2 x 20.3	900.872.15	26.0 x 27.5	900.872.27	29.5 x 31.0
900.872.06	19.5 x 20.5	900.872.16	26.5 x 27.5	900.872.28	30.0 x 31.5
900.872.07	20.0 x 21.25	900.872.17	26.5 x 28.5	900.872.29	30.0 x 32.0
900.872.08	21.0 x 22.5	900.872.18	27.0 x 28.5	900.872.30	31.5 x 33.5
900.872.09	22.25 x 23.75	900.872.19	27.25 x 28.75		
900.872.10	23.0 x 25.0	900.872.21	28.0 x 29.5		

Refills (pack of 3) -

\$2.95pk

Number	Diameter	Number	Diameter	Number	Diameter
900.872.31	16.75 x 15.50	900.872.41	26.50 x 25.00	900.872.51	33.00 x 31.00
900.872.32	17.00 x 15.75	900.872.42	28.00 x 26.50	900.872.52	33.00 x 31.50
900.872.33	17.25 x 16.00	900.872.43	29.00 x 27.50	900.872.53	34.00 x 31.50
900.872.34	19.50 x 18.00	900.872.44	31.25 x 29.25	900.872.54	34.00 x 32.00
900.872.35	19.75 x 18.25	900.872.45	31.25 x 30.00	900.872.55	34.00 x 32.50
900.872.36	20.75 x 19.75	900.872.46	32.25 x 30.00	900.872.56	34.50 x 32.75
900.872.37	21.50 x 20.00	900.872.47	32.50 x 30.00	900.872.57	35.00 x 33.00
900.872.38	22.00 x 20.75	900.872.48	33.00 x 30.00	900.872.58	35.50 x 33.50
900.872.39	23.50 x 22.00	900.872.49	32.25 x 30.50	900.872.59	36.00 x 34.00
900.872.40	24.00 x 22.00	900.872.50	32.75 x 31.00	900.872.60	37.00 x 35.00

Refills (pack of 2) -

\$3.75pk

Flat Gaskets 905.102

50 assorted sizes flat gaskets for waterproof watches. Swiss. Bulk, **no refills.**

905.102 Assortment \$14.95

Large Red Gaskets for Case Backs 903.090L

1 each of 30 sizes.

903.090L Assortment \$42.95

Refills - **\$7.00 ea**

Number	Inside	Outside	Number	Inside	Outside
903.090.31	32.34	33.50	903.090.44	38.84	40.00
903.090.32	32.84	34.00	903.090.45	39.34	40.50
903.090.33	33.34	34.50	903.090.46	39.84	41.00
903.090.34	33.84	35.00	903.090.47	40.34	41.50
903.090.35	34.34	35.50	903.090.48	40.84	42.00
903.090.36	34.84	36.00	903.090.49	41.34	42.50
903.090.37	35.34	36.50	903.090.50	41.84	43.00
903.090.38	35.84	37.00	903.090.51	42.34	43.50
903.090.39	36.34	37.50	903.090.52	42.84	44.00
903.090.40	36.84	38.00	903.090.53	43.34	44.50
903.090.41	37.34	38.50	903.090.54	43.84	45.00
903.090.42	37.84	39.00	903.090.55	44.34	45.50
903.090.43	38.34	39.50	903.090.56	44.84	46.00

Plastic "I" Gaskets for Mineral Crystals 900.851

Refills only; assortment discontinued.
Size is outside diameter.
Refills - **\$9.00/pk of 2**

Number	Diam.	Number	Diam.	Number	Diam.	Number	Diam.	Number	Diam.	Number	Diam.	Number	Diam.
900.851.160	16.0	900.851.188	18.8	900.851.214	21.4	900.851.240	24.0	900.851.266	26.6	900.851.282	28.2	900.851.298	29.8
900.851.164	16.4	900.851.190	19.0	900.851.216	21.6	900.851.242	24.2	900.851.268	26.8	900.851.284	28.4	900.851.300	30.0
900.851.166	16.6	900.851.192	19.2	900.851.218	21.8	900.851.244	24.4	900.851.270	27.0	900.851.286	28.6	900.851.302	30.2
900.851.168	16.8	900.851.194	19.4	900.851.220	22.0	900.851.246	24.6	900.851.272	27.2	900.851.288	28.8	900.851.304	30.4
900.851.170	17.0	900.851.196	19.6	900.851.222	22.2	900.851.252	25.2	900.851.274	27.4	900.851.290	29.0	900.851.306	30.6
900.851.172	17.2	900.851.198	19.8	900.851.224	22.4	900.851.254	25.4	900.851.276	27.6	900.851.292	29.2	900.851.308	30.8
900.851.174	17.4	900.851.200	20.0	900.851.226	22.6	900.851.256	25.6	900.851.278	27.8	900.851.294	29.4	900.851.310	31.0
900.851.176	17.6	900.851.202	20.2	900.851.228	22.8	900.851.258	25.8	900.851.280	28.0	900.851.296	29.6	900.851.312	31.2
900.851.178	17.8	900.851.204	20.4	900.851.230	23.0	900.851.262	26.2						
900.851.180	18.0	900.851.206	20.6	900.851.232	23.2	900.851.264	26.4						
900.851.182	18.2	900.851.208	20.8	900.851.234	23.4								
900.851.184	18.4	900.851.210	21.0	900.851.236	23.6								
900.851.186	18.6	900.851.212	21.2	900.851.238	23.8								

"I" Ring Gaskets for Glass Crystals 940.008

2 each of 59 Sizes, 118 pieces total.
0.80mm Height, 0.35mm Thickness for
1.00mm Glass.
Diameters = Outside x Inside

940.008 Assortment \$54.95

Number	Diameter	Number	Diameter	Number	Diameter
940.008.170	17.0 x 16.3	940.008.260	26.0 x 25.3	940.008.297	29.7 x 29.0
940.008.171	17.1 x 16.4	940.008.270	27.0 x 26.3	940.008.298	29.8 x 29.1
940.008.190	19.0 x 18.3	940.008.272	27.2 x 26.5	940.008.299	29.9 x 29.2
940.008.195	19.5 x 18.8	940.008.274	27.4 x 26.7	940.008.300	30.0 x 29.3
940.008.196	19.6 x 18.9	940.008.276	27.6 x 26.9	940.008.301	30.1 x 29.4
940.008.200	20.0 x 19.3	940.008.278	27.8 x 27.1	940.008.302	30.2 x 29.5
940.008.201	20.1 x 19.4	940.008.280	28.0 x 27.3	940.008.303	30.3 x 29.6
940.008.205	20.5 x 19.8	940.008.282	28.2 x 27.5	940.008.304	30.4 x 29.7
940.008.206	20.6 x 19.9	940.008.284	28.4 x 27.7	940.008.305	30.5 x 29.8
940.008.210	21.0 x 20.3	940.008.285	28.5 x 27.8	940.008.306	30.6 x 29.9
940.008.215	21.5 x 20.8	940.008.286	28.6 x 27.9	940.008.307	30.7 x 30.0
940.008.216	21.6 x 20.9	940.008.287	28.7 x 28.0	940.008.308	30.8 x 30.1
940.008.218	21.8 x 21.1	940.008.289	28.9 x 28.2	940.008.309	30.9 x 30.2
940.008.220	22.0 x 21.3	940.008.290	29.0 x 28.3	940.008.310	31.0 x 30.3
940.008.221	22.1 x 21.4	940.008.291	29.1 x 28.4	940.008.312	31.2 x 30.5
940.008.225	22.5 x 21.8	940.008.292	29.2 x 28.5	940.008.315	31.5 x 30.8
940.008.230	23.0 x 22.3	940.008.293	29.3 x 28.6	940.008.316	31.6 x 30.9
940.008.240	24.0 x 23.3	940.008.294	29.4 x 28.7	940.008.320	32.0 x 31.3
940.008.245	24.5 x 23.8	940.008.295	29.5 x 28.8	940.008.321	32.1 x 31.4
940.008.255	25.5 x 24.8	940.008.296	29.6 x 28.9		

"I" Ring Gaskets for Glass Crystals 940.125

2 each of 49 Sizes, 98 pieces total. 1.25mm
Height, 0.40mm Thickness for 1.50mm
Glass. *Diameters = Outside x Inside*

940.125 Assortment \$49.95

Number	Diameter	Number	Diameter	Number	Diameter
940.125.168	16.8 x 16.0	940.125.253	25.3 x 24.5	940.125.338	33.8 x 33.0
940.125.173	17.3 x 16.5	940.125.258	25.8 x 25.0	940.125.343	34.3 x 33.5
940.125.178	17.8 x 17.0	940.125.263	26.3 x 25.5	940.125.348	34.8 x 34.0
940.125.183	18.3 x 17.5	940.125.268	26.8 x 26.0	940.125.353	35.3 x 34.5
940.125.188	18.8 x 18.0	940.125.273	27.3 x 26.5	940.125.358	35.8 x 35.0
940.125.193	19.3 x 18.5	940.125.278	27.8 x 27.0	940.125.363	36.3 x 35.5
940.125.198	19.8 x 19.0	940.125.283	28.3 x 27.5	940.125.368	36.8 x 36.0
940.125.203	20.3 x 19.5	940.125.288	28.8 x 28.0	940.125.373	37.3 x 36.5
940.125.208	20.8 x 20.0	940.125.293	29.3 x 28.5	940.125.378	37.8 x 37.0
940.125.213	21.3 x 20.5	940.125.298	29.8 x 29.0	940.125.383	38.3 x 37.5
940.125.218	21.8 x 21.0	940.125.303	30.3 x 29.5	940.125.388	38.8 x 38.0
940.125.223	22.3 x 21.5	940.125.308	30.8 x 30.0	940.125.393	39.3 x 38.5
940.125.228	22.8 x 22.0	940.125.313	31.3 x 30.5	940.125.398	39.8 x 39.0
940.125.233	23.3 x 22.5	940.125.318	31.8 x 31.0	940.125.403	40.3 x 39.5
940.125.238	23.8 x 23.0	940.125.323	32.3 x 31.5	940.125.408	40.8 x 40.0
940.125.243	24.3 x 23.5	940.125.328	32.8 x 32.0		
940.125.248	24.8 x 24.0	940.125.333	33.3 x 32.5		

Refills - Packs of 2

\$4.00/pk of 2

Refills - Packs of 2

\$4.00/pk of 2

Large "I" Ring Gaskets 940.008L

20 sizes, 40 pieces. 0.80mm Height,
0.35mm Thickness
Diameters = Outside x Inside

940.008L Assortment \$26.95

Number	Diameter	Number	Diameter	Number	Diameter
940.008.412	41.2 x 40.5	940.008.447	44.7 x 44.0	940.008.482	48.2 x 47.5
940.008.417	41.7 x 41.0	940.008.452	45.2 x 44.5	940.008.487	48.7 x 48.0
940.008.422	42.2 x 41.5	940.008.457	45.7 x 45.0	940.008.492	49.2 x 48.5
940.008.427	42.7 x 42.0	940.008.462	46.2 x 45.5	940.008.497	49.7 x 49.0
940.008.432	43.2 x 42.5	940.008.467	46.7 x 46.0	940.008.502	50.2 x 49.5
940.008.437	43.7 x 43.0	940.008.472	47.2 x 46.5	940.008.507	50.7 x 50.0
940.008.442	44.2 x 43.5	940.008.477	47.7 x 47.0		

Large "I" Ring Gaskets 940.125L

20 sizes, 40 pieces. 1.25mm Height,
0.40mm Thickness
Diameters = Outside x Inside

940.125L Assortment \$26.95

Number	Diameter	Number	Diameter	Number	Diameter
940.175.413	41.3 x 40.5	940.175.448	44.8 x 44.0	940.175.483	48.3 x 47.5
940.175.418	41.8 x 41.0	940.175.453	45.3 x 44.5	940.175.488	48.8 x 48.0
940.175.423	42.3 x 41.5	940.175.458	45.8 x 45.0	940.175.493	49.3 x 48.5
940.175.428	42.8 x 42.0	940.175.463	46.3 x 45.5	940.175.498	49.8 x 49.0
940.175.433	43.3 x 42.5	940.175.468	46.8 x 46.0	940.175.503	50.3 x 49.5
940.175.438	43.8 x 43.0	940.175.473	47.3 x 46.5	940.175.508	50.8 x 50.0
940.175.443	44.3 x 43.5	940.175.478	47.8 x 47.0		

Refills - Packs of 2

\$4.00/pk of 2

Refills - Packs of 2

\$4.00/pk of 2

GASKET ASSORTMENTS - CRYSTAL

"I" Ring Gaskets for Glass Crystals

940.175

Two each of 49 Sizes, 98 pieces total.
1.75mm height, 0.40mm thickness for
2.00mm glass. *Diameters = Outside x Inside*

940.175 Assortment \$49.95

Number	Diameter	Number	Diameter	Number	Diameter
940.175.168	16.8 x 16.0	940.175.253	25.3 x 24.5	940.175.338	33.8 x 33.0
940.175.173	17.3 x 16.5	940.175.258	25.8 x 25.0	940.175.343	34.3 x 33.5
940.175.178	17.8 x 17.0	940.175.263	26.3 x 25.5	940.175.348	34.8 x 34.0
940.175.183	18.3 x 17.5	940.175.268	26.8 x 26.0	940.175.353	35.3 x 34.5
940.175.188	18.8 x 18.0	940.175.273	27.3 x 26.5	940.175.358	35.8 x 35.0
940.175.193	19.3 x 18.5	940.175.278	27.8 x 27.0	940.175.363	36.3 x 35.5
940.175.198	19.8 x 19.0	940.175.283	28.3 x 27.5	940.175.368	36.8 x 36.0
940.175.203	20.3 x 19.5	940.175.288	28.8 x 28.0	940.175.373	37.3 x 36.5
940.175.208	20.8 x 20.0	940.175.293	29.3 x 28.5	940.175.378	37.8 x 37.0
940.175.213	21.3 x 20.5	940.175.298	29.8 x 29.0	940.175.383	38.3 x 37.5
940.175.218	21.8 x 21.0	940.175.303	30.3 x 29.5	940.175.388	38.8 x 38.0
940.175.223	22.3 x 21.5	940.175.308	30.8 x 30.0	940.175.393	39.3 x 38.5
940.175.228	22.8 x 22.0	940.175.313	31.3 x 30.5	940.175.398	39.8 x 39.0
940.175.233	23.3 x 22.5	940.175.318	31.8 x 31.0	940.175.403	40.3 x 39.5
940.175.238	23.8 x 23.0	940.175.323	32.3 x 31.5	940.175.408	40.8 x 40.0
940.175.243	24.3 x 23.5	940.175.328	32.8 x 32.0		
940.175.248	24.8 x 24.0	940.175.333	33.3 x 32.5		

Refills - Packs of 2

\$4.00/pk of 2

Large "I" Ring Gaskets

940.175L

20 sizes, 40 pieces. 1.25mm height,
0.40mm thickness *Diameters = Outside x Inside*

940.125L Assortment \$26.95

Number	Diameter	Number	Diameter	Number	Diameter
940.125.413	41.3 x 40.5	940.125.453	45.3 x 44.5	940.125.493	49.3 x 48.5
940.125.418	41.8 x 41.0	940.125.458	45.8 x 45.0	940.125.498	49.8 x 49.0
940.125.423	42.3 x 41.5	940.125.463	46.3 x 45.5	940.125.503	50.3 x 49.5
940.125.428	42.8 x 42.0	940.125.468	46.8 x 46.0	940.125.508	50.8 x 50.0
940.125.433	43.3 x 42.5	940.125.473	47.3 x 46.5		
940.125.438	43.8 x 43.0	940.125.478	47.8 x 47.0		
940.125.443	44.3 x 43.5	940.125.483	48.3 x 47.5		
940.125.448	44.8 x 44.0	940.125.488	48.8 x 48.0		

Refills - Packs of 2

\$4.00/pk of 2

Generic Case Back Gaskets to fit RLX

910.105

105 piece assortment contains sizes to fit
RLX.

910.105 Assortment \$47.95

R29.182.84	R29.216.5	R29.290.8	R29.310.56
R29.192.86	R29.240.76	R29.292.76	R29.312.8
R29.205.105	R29.243.86	R29.292.85	R29.317.8
R29.208.8	R29.245.105	R29.293.106	R29.317.10
R29.210.74	R29.250.8	R29.298.8	R29.322.10
R29.210.124	R29.265.106	R29.302.86	R29.325.10
R29.213.66	R29.270.75	R29.303.8	R29.337.8
R29.214.64	R29.270.8	R29.307.9	R29.337.10
R29.215.8	R29.287.105	R29.310.8	

Refills - \$2.50 ea 3@\$2.25 ea

Crystal Gaskets to fit TAG Heuer

Sold Individually \$7.75 each

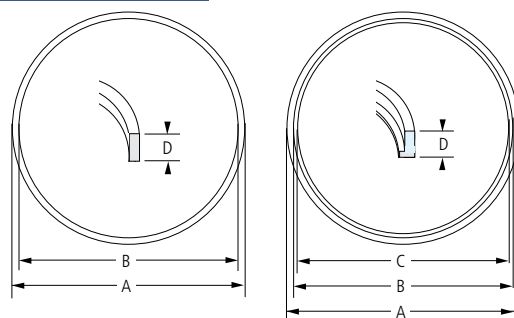

Generic Crystal Gaskets to fit TAG Heuer

Number	A	B	D
999.102.01	16.5	15.8	1.00
999.102.02	20.2	19.5	1.00
999.102.03	20.2	19.0	1.05
999.102.04	25.6	24.4	1.00
999.102.05	26.6	25.4	1.13
999.102.06	27.6	25.4	1.10
999.102.07	29.2	28.0	1.35
999.102.08	26.2	25.0	1.27
999.102.09	25.5	24.3	1.00

Generic Crystal Gaskets with Lip to fit TAG Heuer

Number	A	B	C	D
999.102.10	28.3	27.1	26.1	1.85
999.102.11	32.1	30.9	30.0	1.70
999.102.12	29.7	28.5	27.6	1.55

Lip Height is 0.50mm

Inch to Millimeter Conversion

1/4"	6mm	5/8"	16mm
5/16"	8mm	11/16"	18mm
3/8"	10mm	3/4"	19mm
7/16"	11mm	13/16"	21mm
1/2"	13mm	7/8"	22mm
9/16"	14mm	1"	25mm

Generic Crystal Gaskets to fit RLX



R29.192.1	\$3.25
R29.206.1	\$3.25
R29.246.1	\$7.25
R29.282.1	\$7.25
R29.286.1	\$7.25
R29.286.1H High	\$7.25
R29.295.1	\$3.25
R29.295.2 High	\$7.25

Battery Hatch Gaskets

900.002

25 Flat Gaskets, ISO battery F.
Bulk, **no refills.**
900.002 Assortment **\$15.95**

Battery Hatch Gaskets O-Ring

900.003

25 "O"-Ring Gaskets, ISO battery F.
Bulk, **no refills.**
900.003 Assortment **\$16.95**

Mini O-Rings for Crowns

900.610

10 each of 17 sizes.
900.610 Assortment **\$29.95**

Number	In -side	Thick -ness	Out -side	Number	In -side	Thick -ness	Out -side
900.610.01	0.50	0.30	1.10	900.610.10	0.60	0.55	1.70
900.610.02	0.50	0.40	1.30	900.610.11	0.60	0.60	1.80
900.610.03	0.50	0.45	1.40	900.610.12	0.60	0.65	1.90
900.610.04	0.50	0.50	1.50	900.610.13	0.70	0.40	1.50
900.610.05	0.64	0.31	1.26	900.610.14	0.70	0.45	1.60
900.610.06	0.60	0.35	1.30	900.610.15	0.70	0.50	1.70
900.610.07	0.60	0.40	1.40	900.610.16	0.70	0.55	1.80
900.610.08	0.60	0.45	1.50	900.610.17	0.70	0.60	1.90
900.610.09	0.60	0.50	1.60				

Refills - **\$7.50 pack of 10 of one size**

Mini O-Ring Gaskets

906.092

Assortment of 60 Swiss miniature O-Ring gaskets (5 each of 12 sizes) for waterproof crowns, tubes and buttons.
906.092 Assortment **\$44.95**

Number	Inside	Thick	Out	Number	Inside	Thick	Out
906.092.01	0.60	0.70	2.00	906.092.07	1.40	0.40	2.20
906.092.02	0.65	0.40	1.45	906.092.08	1.55	0.70	2.95
906.092.03	0.70	0.55	1.80	906.092.09	1.60	0.50	2.60
909.092.04	0.70	0.75	2.20	906.092.10	1.80	0.40	2.60
906.092.05	0.80	0.50	1.80	906.092.11	1.80	0.60	3.20
906.092.06	0.80	0.70	2.20	906.092.12	2.20	0.50	3.20

Refills - **\$9.00 pack of 10 of one size**

Mini O-Ring Gaskets

906.093

Assortment of 60 miniature O-Ring gaskets (5 each of 12 sizes, bottles 13-24) for waterproof crowns, tubes and buttons. Made in Switzerland.
906.093 Assortment **\$44.95**

Number	In -side	Thick -ness	Out -side	Number	In -side	Thick -ness	Out -side
906.093.13	0.50	0.30	1.10	906.093.19	1.00	0.50	2.00
906.093.14	0.60	0.35	1.30	906.093.20	1.10	0.40	1.90
906.093.15	0.80	0.40	1.60	906.093.21	1.20	0.55	2.30
906.093.16	0.80	0.60	2.00	906.093.22	1.20	0.65	2.50
906.093.17	0.90	0.40	1.70	906.093.23	1.30	0.40	2.10
906.093.18	1.00	0.40	1.80	906.093.24	1.40	0.60	2.60

Refills - **\$9.00 pack of 10 of one size**

Crystal & Case Back Gaskets to fit Cartier

Generic gaskets to fit Cartier Roadster, Santos and Ballon Bleu watches.

Sold Individually, below **\$10.95 ea**

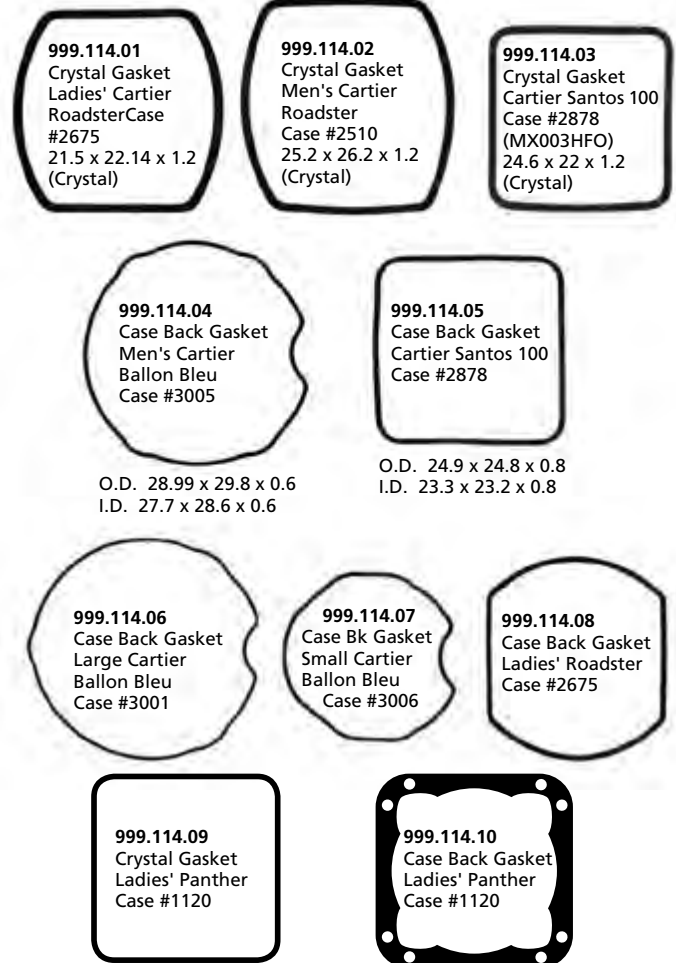

Crown & Tube Gaskets

999.101



Assortment contains 66 gaskets total to fit seven RLX numbers, and one each to fit TAG, Cartier and Baume & Mercier.

Number	Size	Gasket for	Refill	3@ea	12@ea
999.101	Gasket Assortment		\$34.95		
R530T	5.30	Rolex Tube	\$2.00	\$1.50	\$1.00
R530C	5.30	Rolex Crown	\$2.00	\$1.50	\$1.00
R600T	6.00	Rolex Tube 7.00/7.03	\$2.00	\$1.50	\$1.00
R600C	6.00	Rolex Crown	\$2.00	\$1.50	\$1.00
R700C	7.00	Rolex Crown	\$2.00	\$1.50	\$1.00
R703P	7.03	Rolex Outside Tube	\$2.00		
R703S	7.03	Rolex Flat btwn Tube & Case	\$3.00		
999.100.09		TAG Crown	\$2.00		
999.100.10		Cartier Crown	\$2.00		
999.100.11		Baume & Mercier Crown	\$2.00		

Refills - see above prices

HAND ASSORTMENTS - DAUPHINE & STICK

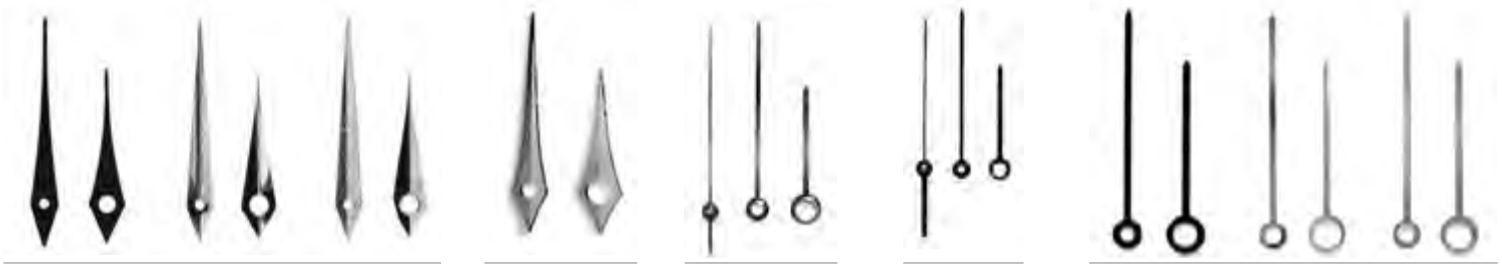

900.012, .013, .014
Dauphine

900.036, .038
Dauphine

900.861
Stick

910.669
Stick

910.106
Stick

Dauphine Hands 900.012, .013, .014

36 pair (3 ea of 12 pair) Yellow Gilt, White or Black Dauphine pitched hands. Swiss made.

- 900.012 Yellow Assortment **\$52.95**
- 900.013 White Assortment **\$52.95**
- 900.014 Black Assortment **\$54.95**

Black Number	White Number	Yellow Number	Hole Size	Length Minute	Length Hour
900.014.01	----	----	70 x 120	5.00	3.00
900.014.02	900.013.02	900.012.02	60 x 110	5.00	3.00
900.014.03	900.013.03	----	55 x 100	5.00	3.00
900.014.04	----	----	70 x 120	7.00	4.50
900.014.05	900.013.05	900.012.05	60 x 110	7.00	4.50
900.014.06	----	900.012.06	55 x 100	7.00	4.50
900.014.07	----	----	70 x 120	8.00	5.50
900.014.08	900.013.08	900.012.08	60 x 110	8.00	5.50
900.014.09	900.013.09	900.012.09	55 x 100	8.00	5.50
900.014.10	----	----	70 x 120	11.00	7.50
900.014.11	900.013.11	900.012.11	60 x 110	11.00	7.50
900.014.12	900.013.12	----	55 x 100	11.00	7.50

Refills - Black Only

\$4.75 pr 3pr@\$4.25 6pr@\$3.75 12pr@\$3.50

Refills on White & Yellow use 900.036 and 900.038.

Diamond Cut Dauphine Hands 900.036, .038

36 pair (3 each of 12 pair) high quality, highly polished yellow gilt or white diamond cut Dauphine hands to fit most modern quartz and mechanical movements. Swiss made.

- 900.036 Yellow Assortment **\$54.95**
- 900.038 White Assortment **\$54.95**

White Number	White Number	Hole Size	Length Minute	Length Hour
900.036.01	900.038.01	40 x 80	3.50	2.00
900.036.02	900.038.02	45 x 90	5.00	3.00
900.036.03	900.038.03	55 x 100	5.00	3.00
900.036.04	900.038.04	60 x 110	5.00	3.00
900.036.05	900.038.05	70 x 120	5.00	3.00
900.036.06	900.038.06	55 x 100	7.00	4.50
900.036.07	900.038.07	70 x 120	7.00	4.50
900.036.08	900.038.08	65 x 110	8.00	5.50
900.036.09	900.038.09	70 x 120	8.00	5.50
900.036.10	900.038.10	65 x 110	11.00	7.50
900.036.11	900.038.11	70 x 120	11.00	7.50
900.036.12	900.038.12	90 x 150	12.00	9.50
900.036.13	900.038.13	45 x 90	3.50	2.00

Additional sizes available, not in assortment:

900.036.14	900.038.14	45 x 90	5.50	8.00
900.036.15	900.038.15	55 x 100	11.00	7.70

Refills

\$4.50 pr 3pr@\$4.00 6pr@\$3.50 12pr@\$3.00

Hour, Minute & Sweep Hands for Quartz 900.861

3 each 11 sizes Yellow & White Hour & Minute Hands, and 3 each 7 sizes Yellow & White Sweep Second Hands.

- 900.861 Assortment **\$59.95**

White Number	Yellow Number	Hole Size	Type	Length
900.861.34	900.861.31	40/80	Minute/Hour	
900.861.16	900.861.01	45/90	Minute/Hour	
900.861.35	900.861.32	50/100	Minute/Hour	
900.861.17	900.861.02	55/100	Minute/Hour	
900.861.18	900.861.03	60/110	Minute/Hour	
900.861.36	900.861.33	65/110	Minute/Hour	
900.861.19	900.861.04	65/120	Minute/Hour	
900.861.22	900.861.07	70/120	Minute/Hour	
900.861.20	900.861.05	80/130	Minute/Hour	
900.861.21	900.861.06	80/140	Minute/Hour	
900.861.23	900.861.08	90/150	Minute/Hour	
900.861.24	900.861.09	0.17	Sweep Second	8
900.861.30	900.861.15	0.17	Sweep Second	13
900.861.25	900.861.10	0.18	Sweep Second	11
900.861.26	900.861.11	0.19	Sweep Second	10
900.861.27	900.861.12	0.20	Sweep Second	13
900.861.28	900.861.13	0.22	Sweep Second	15
900.861.29	900.861.14	0.25	Sweep Second	15

Hour & Minute Refills - **\$3.75 pr 3pr@\$3.25**

Sweep Seconds Refills - **\$3.50 ea 3@\$2.95**

Black Bergeon Hour, Minute & Sweep Hands for Quartz Watches 906.669

Assortment discontinued. Limited supply of refills available.

Number	Holes	ligne	Number	Holes	ligne
906.669.39	45/90	5½	906.669.47	0.19	8¾
906.669.40	55/100	5½	906.669.48	0.20	11½
906.669.42	65/120	7¾	906.669.49	0.25	11½
906.669.43	80/130	8¾	906.669.50	0.17	12½

Refills Only- **\$3.95 pr 3pr@\$3.50 pr**

Hour & Minute Stick Hands 910.106

Black, Yellow and White. Swiss made.

Refills only.

SKU	Holes	SKU	Holes	SKU	Holes
910.106.01	40/80	910.106.04	55/100	910.106.07	65/120
910.106.02	45/90	910.106.05	60/110	910.106.08	70/120
910.106.03	50/100	910.106.06	60/120	910.106.09	90/150

Refills - Order by SKU Number & Color (W, Y, or B) **\$3.75 pr**



900.199, 900.299



900.624



900.862



999.642

Luminous Sports Hands 900.199

\$450 VALUE!

Heavy luminous hands for men's watches. 9 types yellow and white, a total of 70 pair hour and minute, and 20 sweep second hands. Swiss made.

900.199 Assortment \$92.95

White Number	Yellow Number	Holes	Length	Style
900.199.01	900.199.10	70/120	8 x 12.5	Tear Drop
900.199.02	900.199.11	70/120	8 x 12.5	Mercedes
900.199.03	900.199.12	70/120	8.5 x 12.5	Sport
900.199.04	900.199.13	70/120	8.5 x 12.5	Arrow
900.199.05	900.199.14	70/120	8.5 x 12.5	Stick Wide
900.199.06	900.199.15	70/120	8.5 x 12.5	Alpha
900.199.07	900.199.16	70/120	8.5 x 12.5	Wide
900.199.08	900.199.17	20	12.50	Lum. Arrow
900.199.09	900.199.18	20	12.50	Lum. Dot

Refills - - Hour & Minute **\$5.00 pr/Second \$5.00 ea**

Luminous Sports Hands 900.299

\$450 VALUE!

Heavy luminous hands for men's watches. 9 types yellow and white, a total of 70 pair hour and minute, and 20 sweep second hands. Swiss made.

900.299 Assortment \$149.95

White Number	Yellow Number	Holes	Length	Style
900.299.01	900.299.10	90/150	8 x 12.5	Tear Drop
900.299.02	900.299.11	90/150	8 x 12	Mercedes
900.299.03	900.299.12	90/150	8.5 x 12.5	Sport
900.299.04	900.299.13	90/150	8.5 x 12.5	Arrow
900.299.05	900.299.14	90/150	7.5 x 11.5	Stick Wide
900.299.06	900.299.15	90/150	8.5 x 12	Alpha
900.299.07	900.299.16	90/150	8.5 x 12	Wide
900.299.08	900.299.17	25	12.50	Lum. Arrow
900.299.09	900.299.18	25	12.50	Lum. Dot

Refills - - Hour & Minute **\$5.00 pr/Second \$5.00 ea**

Luminous Hands 900.624

Yellow baton style pointed luminous hands for quartz watches. 36 pair, 12 sizes.

900.624 Assortment \$43.95

Number	Holes	Length	Number	Holes	Length
900.624.01	55/100	5 x 8	900.624.07	60/110	7 x 12
900.624.02	55/100	6 x 9	900.624.08	60/110	8 x 12
900.624.03	55/100	7 x 11	900.624.09	70/120	5 x 8
900.624.04	55/100	8 x 12	900.624.10	70/120	6 x 9
900.624.05	60/110	5 x 8	900.624.11	70/120	7 x 11
900.624.06	60/110	6 x 9	900.624.12	70/120	8 x 12

Refills **\$4.50 pr 3pr@\$4.00**

Generic Hands to fit RLX 900.862

\$79.80 VALUE!

Diamond cut hands, same high quality as the genuine. 1 set each of the 4 most popular styles.

900.862 Assortment \$65.95

R1530SD (1565, 1575) White Diver Refills **\$19.95/set**
R1570Y (1530, 1575) Yellow Lum.
R2035Y (2030) Yellow Luminous
R2135Y (2130) Yellow Luminous

Luminous Hands 999.642

44 pair hour and minute hands, and 4 sweep second hands, yellow and white. Sweep hands have a luminous dot.

999.642 Assortment \$44.95

White Number	Yellow Number	Hole Size	Length	Style
999.642.01W	999.642.01Y	65/110	5 x 7	Luminous
999.642.02W	999.642.02Y	65/110	6 x 9	Luminous
999.642.03W	999.642.03Y	65/110	8 x 12	Luminous
999.642.04W	999.642.04Y	70/120	6 x 9	Luminous
999.642.05W	999.642.05Y	70/120	6 x 9	Mercedes
999.642.06W	999.642.06Y	70/120	8 x 12	Luminous
999.642.07W	999.642.07Y	70/120	8 x 12	Mercedes
999.642.08W	999.642.08Y	85/135	6 x 9	Luminous
999.642.09W	999.642.09Y	85/135	8 x 12	Luminous
999.642.10W	999.642.10Y	90/150	8 x 12	Luminous
999.642.11W	999.642.11Y	90/150	8 x 12	Mercedes
999.642.12W	999.642.12Y	20	12.5	Sweep/Dot

Refills also available in these sizes (not in assortment):

999.642.13W 999.642.13Y 100/150 8 x 12 Luminous
999.642.14W not available 100/150 8 x 12 Mercedes

Refills - **\$4.50 pr 3pr@\$4.00 6pr@\$3.50 12pr@\$3.00**

Inch to Millimeter Conversion

1/4"	6mm	5/8"	16mm
5/16"	8mm	11/16"	18mm
3/8"	10mm	3/4"	19mm
7/16"	11mm	13/16"	21mm
1/2"	13mm	7/8"	22mm
9/16"	14mm	1"	25mm

Hour & Minute Hands for Chronometers 901.023

144 assorted hands. Swiss made.
Bulk - No Refills.

901.023 Assortment \$29.95



Swiss Small Second/Recorder Hands 999.500

Small Baton and Alpha style second hands in Yellow, White and Black. Individual hands, price each. Baton Hole 18, 20, 26. Limited supply on Alpha.

Limited supply - call for size and availability. 1-800-487-0408.

Refills only \$3.50 ea
3@\$3.25 6@\$3.00 12@\$2.75



Small Second Hands for Wrist Watches 901.030B

144 second hands, assorted styles and colors. Swiss. Bulk, No Refills.

901.030B Assortment \$49.95



Small Second Hands for Quartz Watches 901.030Q

144 second hands, assorted styles and colors. Swiss. Bulk, No Refills.

901.030Q Assortment \$43.95



Small Second Hands 901.056

144 assorted small second hands. Swiss. Bulk, No Refills.

901.056 Assortment \$59.95



Small Second Hands 906.015

400 piece assortment (10 pcs ea size, color, style). Hole sizes .16, .17, .20, .26. Yellow, black, red, silver, white in Alpha and Baton styles. No Refills.

906.015 Assortment \$69.95



Center Second Hands for Chronographs 901.035

144 sweep second hands, assorted styles and colors. Swiss made.

Bulk, No Refills.

901.035 Assortment \$49.95



Sweep Second Hands for Wrist Watches 901.050B

144 assorted center sweep second hands for regular wrist watches. Swiss made.

Bulk, No Refills.

901.050B Assortment \$45.95



Sweep Second Hands 901.070

144 assorted yellow, white and black Sweep Second Hands for quartz watches. Assorted hole sizes. Swiss made.

Bulk, No Refills.

901.070 Assortment \$54.95



Movement Holders 900.025

25 of the most popular plastic movement holders. Swiss made. Bulk, No Refills.

900.025 Assortment \$16.95

Movement Holders

Plastic rings make movement replacement easier. Bulk Assortment Pack contains 54 pieces, 2 each of 27 sizes. No Refills available.

999.625 Assortment Pack \$25.95

Each individual assortment contains 10 - 12 movement rings each for one size ligne movements.



999.625.03 Asst. for 3³/₄ ligne \$9.95

3³/₄ x 6 Height 1.80mm

3 3/4 x 6 Height 1.95mm

999.625.05 Asst. for 5¹/₂ ligne \$9.95

5 1/2 Height 2.20mm

5 1/2 Height 2.50mm

5 1/2 x 6 3/4 Height 1.95mm

5 1/2 x 6 3/4 Height 2.20mm

5 1/2 x 6 3/4 Height 2.54mm

5 1/2 x 6 3/4 Height 3.26mm

999.625.06 Asst. for 6x8 ligne \$9.95

6 3/4 x 8 Height 2.28mm

6 3/4 x 8 Height 2.50mm

6 3/4 x 8 Height 2.95mm

6 3/4 x 8 Height 3.15mm

999.625.07 Asst. for 7³/₄ ligne \$7.95

7 3/4 Height 2.50mm

999.625.08 Asst. for 8³/₄ ligne \$7.95

8 3/4 Height 2.50mm

8 3/4 Height 3.40mm

999.625.10 Asst. for 10¹/₂ ligne \$9.95

10 1/2 Height 1.95mm

10 1/2 Height 2.50mm

10 1/2 Height 2.62mm

10 1/2 Height 3.40mm

10 1/2 Height 4.15mm

999.625.11 Asst. for 11¹/₂ ligne \$9.95

11 1/2 Height 1.95mm

11 1/2 Height 2.50mm

11 1/2 Height 2.62mm

11 1/2 Height 3.00mm

11 1/2 Height 4.60mm

999.625.13 Asst. for 13¹/₂ ligne \$9.95

13 1/4 Height 4.60mm

13 1/4 Height 5.12mm

Case Clamps 912.402

100 piece assortment of case clamps. Comes in 5 different styles. No Refills.

912.402 Assortment \$39.95



Dial Dots and Strips 910.041, .042

Self adhesive Dots 3mm, or Strips 12x2mm for attaching dials to movements. No Refills available.

910.041 Dots Assortment \$4.95

910.042 Strips Assortment \$5.95



Dial Feet 910.040

100 assorted Bergeon dial feet for wrist watches. No Refills available.

910.040 Assortment \$16.95



Pins for Case Hinges 904.401

100 assorted Case Joint Pins for case hinges. Brass or Nickel. Swiss made.

904.401 Brass Assortment \$19.95

904.402 Nickel Assortment \$21.95

No refills available.



Incabloc Shock Springs, Caps & Hole Jewels 999.400

72 pieces incabloc shock springs, cap jewels, and hole jewels.

999.400 Assortment \$129.95

Refill Number	Description
400/4	Inca Springs
400/811	Inca Springs
400/7	Cap Jewels
400/8	Cap Jewels
400/11	Hole Jewels
400/66	Inca Springs
400/68	Cap Jewels
400/1313	Inca Springs
400/1410	Inca Springs
400/1461	Inca Springs
400/1409	Inca Springs
400/1711	Inca Springs
400/1775	Inca Springs
400/1753	Inca Springs
400/1621	Inca Springs
400/1830	Cap Jewels
400/1620	Cap Jewels
End of 400	Inca Jewels



BATTERY PARTS ASSORTMENTS

Battery Parts 904.903



Assortment of 200 parts for replacing watch batteries. Insulators, small cell cover O-rings, cell clamps and screws and circuit screws. Swiss.

904.903 Assortment **\$44.95**

Crown/Battery Stopper 905.655 905.665 905.685



12 pieces 0.55 thick, 5.8mm length.
905.655 Assortment **\$2.95**

12 pieces 0.65 thick, 5.8mm length.
905.665 Assortment **\$2.95**

12 pieces 0.85 thick, 5.8mm length.
905.685 Assortment **\$2.95**

ETA Battery Straps 906.042

Original battery straps for ETA movements. Order refills by X-Part Number where available.

906.042 Assortment **\$59.95**

MVT #	PART	DESCRP	PART #
210.001	4400	Battery Clamp H .145	X/11708
210.001	4401	Bridle + H 1.45	X/11710
251.262	4400	Battery Clamp	X/13930
251.262	4401	Bridle +	X/13924
280.002	4400	Battery Clamp	X/12083
280.002	4401	Bridle +	X/12084
282.001	4401	Bridle +	X/12443
282.002	4402	Bridle -	X/14171
901.001	4401	Bridle +	N/A
902.002	4401	Bridle + Gold Plated	N/A
955.112	4407	Bridle +	X/8215
976.001	4400	Battery Clamp +	X/11052
980.106	4401	Bridle + Gold Plated	X/13334
980.106	4402	Bridle + Gold Plated	X/13335
E03.001	4400	Bridle +	N/A
F03.111	4402	Bridle -	N/A
F03.111	4407	Bridle +	N/A
F05.111	4407	Bridle +	N/A

Refills - Order by X/ part number.
Prices vary, call for current price.



Battery Clamp Screws 910.217

50 assorted Screws for Battery Clamps.
Bulk, No Refills available.

910.217 Assortment **\$24.95**

Battery Clamps 910.219

50 assorted Battery Clamps.
Bulk - No Refills available.

910.219 Assortment **\$24.95**

Battery Insulators 900.044

144 Assorted Insulators for Quartz
Watches. Bulk - No Refills available.

900.044 Assortment **\$29.95**



Battery Clamps for Miyota Movements 999.077

33 piece assortment contains
3 each of 11 numbers.

999.077 Assortment **\$24.95**

CIT231-105 **CIT231-183**
CIT231-153 **CIT231-1634**
CIT231-163 **CIT231-345**
CIT231-174 **CIT231-347**
CIT231-3681 **CIT231-368**
CIT231-182

Limited Supply - Some Refills
available.



**Batteries + Battery Kits
see pages 436-437**

Nose Pad Guard Arms 821.900

30 pair arms; 20 pair of screw and push base for soldering on metal frames and 10 pair of screw and push base for plastic frame insertion.

821.900 Assortment **\$49.95**



Eyeglass Screws 811.701

Contains 100 each of 10 screw sizes and 2 nut sizes. Individual vials packed in a handy organizer case with identifying chart.

811.701 Assortment **\$69.95**
No Refills available.



Nose Pad Kit 871.150

Symmetrical silicone push and screw base kit contains three sizes, 25 pair of each style.

871.150 Assortment **\$59.95**



Screw Assortment, Self-Tapping Optical 821.910

300 Screws, 50 each of 6 sizes all 9mm long. Diameters: 1.2, 1.3, 1.4 and 1.5mm with small and large heads. Stainless steel, color coded, nylok coated, strong heads.

821.910 Assortment **\$66.50**



Optical Screws 909.260

144 assorted yellow and white. Swiss made. Bulk.

909.260 Assortment **\$23.95**
Bulk, No Refills available.



Optical Screws 800.500

1000 piece Assortment includes 7 different sizes for eyeglasses and 3 assortments of miniature screws for watches. In a handy dispenser.

800.500 Assortment **\$39.95**

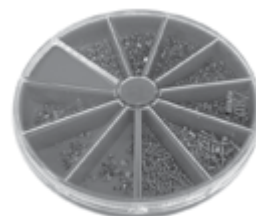

Questions
about your order?

Call us!

We're ready to help.

1.800.487.0408

CAS-KER FLAT PLAIN MINERAL GLASS WATCH CRYSTALS

TCK 0.80 Flat

0.80mm thick, flat.

900.015	15 piece Asst. 12-19mm	\$19.00
900.023	25 piece Asst. 19-30mm	\$31.25
Refills \$1.50each, 3 of a size@\$0.95ea		

TCK.10.0	TCK.16.8	TCK.21.9	TCK.27.1
TCK.10.5	TCK.16.9	TCK.22.0	TCK.27.2
TCK.11.0	TCK.17.0	TCK.22.1	TCK.27.3
TCK.11.5	TCK.17.1	TCK.22.2	TCK.27.4
TCK.12.0	TCK.17.2	TCK.22.3	TCK.27.5
TCK.12.1	TCK.17.3	TCK.22.4	TCK.27.6
TCK.12.2	TCK.17.4	TCK.22.5	TCK.27.7
TCK.12.3	TCK.17.5	TCK.22.6	TCK.27.8
TCK.12.4	TCK.17.6	TCK.22.7	TCK.27.9
TCK.12.5	TCK.17.7	TCK.22.8	TCK.28.0
TCK.12.6	TCK.17.8	TCK.22.9	TCK.28.1
TCK.12.7	TCK.17.9	TCK.23.0	TCK.28.2
TCK.12.8	TCK.18.0	TCK.23.1	TCK.28.3
TCK.12.9	TCK.18.1	TCK.23.2	TCK.28.4
TCK.13.0	TCK.18.2	TCK.23.3	TCK.28.5
TCK.13.1	TCK.18.3	TCK.23.4	TCK.28.6
TCK.13.2	TCK.18.4	TCK.23.5	TCK.28.7
TCK.13.3	TCK.18.5	TCK.23.6	TCK.28.8
TCK.13.4	TCK.18.6	TCK.23.7	TCK.28.9
TCK.13.5	TCK.18.7	TCK.23.8	TCK.29.0
TCK.13.6	TCK.18.8	TCK.23.9	TCK.29.1
TCK.13.7	TCK.18.9	TCK.24.0	TCK.29.2
TCK.13.8		TCK.24.1	TCK.29.3
TCK.13.9	TCK.19.0	TCK.24.2	TCK.29.4
TCK.14.0	TCK.19.1	TCK.24.3	TCK.29.5
TCK.14.1	TCK.19.2	TCK.24.4	TCK.29.6
TCK.14.2	TCK.19.3	TCK.24.5	TCK.29.7
TCK.14.3	TCK.19.4	TCK.24.6	TCK.29.8
TCK.14.4	TCK.19.5	TCK.24.7	TCK.29.9
TCK.14.5	TCK.19.6	TCK.24.8	TCK.30.0
TCK.14.6	TCK.19.7	TCK.24.9	TCK.30.1
TCK.14.7	TCK.19.8	TCK.25.0	TCK.30.2
TCK.14.8	TCK.19.9	TCK.25.1	TCK.30.3
TCK.14.9	TCK.20.0	TCK.25.2	TCK.30.4
TCK.15.0	TCK.20.1	TCK.25.3	TCK.30.5
TCK.15.1	TCK.20.2	TCK.25.4	TCK.30.6
TCK.15.2	TCK.20.3	TCK.25.5	TCK.30.7
TCK.15.3	TCK.20.4	TCK.25.6	TCK.30.8
TCK.15.4	TCK.20.5	TCK.25.7	TCK.30.9
TCK.15.5	TCK.20.6	TCK.25.8	TCK.31.0
TCK.15.6	TCK.20.7	TCK.25.9	TCK.31.1
TCK.15.7	TCK.20.8	TCK.26.0	TCK.31.2
TCK.15.8	TCK.20.9	TCK.26.1	TCK.31.3
TCK.15.9	TCK.21.0	TCK.26.2	TCK.31.4
TCK.16.0	TCK.21.1	TCK.26.3	TCK.31.5
TCK.16.1	TCK.21.2	TCK.26.4	TCK.31.6
TCK.16.2	TCK.21.3	TCK.26.5	TCK.31.7
TCK.16.3	TCK.21.4	TCK.26.6	TCK.31.8
TCK.16.4	TCK.21.5	TCK.26.7	TCK.31.9
TCK.16.5	TCK.21.6	TCK.26.8	TCK.32.0
TCK.16.6	TCK.21.7	TCK.26.9	
TCK.16.7	TCK.21.8	TCK.27.0	

XMG 1.00 Flat

1.00mm thick, flat.

\$4.50each

XMG.39.5	XMG.41.0	XMG.42.5	XMG.44.0	XMG.45.5
XMG.40.0	XMG.41.5	XMG.43.0	XMG.44.5	XMG.46.0
XMG.40.5	XMG.42.0	XMG.43.5	XMG.45.0	

CK 1.00 Flat

1.00mm thick, flat.

900.100	100 pc Asst. 14-31mm	\$69.95
900.039	25 piece Asst. 31-39mm	\$26.95
Refills \$1.50each, 3 of a size@\$0.95ea		

CK.12.0	CK.16.7	CK.21.4	CK.26.1	CK.30.8
CK.12.1	CK.16.8	CK.21.5	CK.26.2	CK.30.9
CK.12.2	CK.16.9	CK.21.6	CK.26.3	
CK.12.3	CK.17.0	CK.21.7	CK.26.4	CK.31.0
CK.12.4	CK.17.1	CK.21.8	CK.26.5	CK.31.1
CK.12.5	CK.17.2	CK.21.9	CK.26.6	CK.31.2
CK.12.6	CK.17.3	CK.22.0	CK.26.7	CK.31.3
CK.12.7	CK.17.4	CK.22.1	CK.26.8	CK.31.4
CK.12.8	CK.17.5	CK.22.2	CK.26.9	CK.31.5
CK.12.9	CK.17.6	CK.22.3	CK.27.0	CK.31.6
CK.13.0	CK.17.7	CK.22.4	CK.27.1	CK.31.7
CK.13.1	CK.17.8	CK.22.5	CK.27.2	CK.31.8
CK.13.2	CK.17.9	CK.22.6	CK.27.3	CK.31.9
CK.13.3	CK.18.0	CK.22.7	CK.27.4	CK.32.0
CK.13.4	CK.18.1	CK.22.8	CK.27.5	CK.32.1
CK.13.5	CK.18.2	CK.22.9	CK.27.6	CK.32.2
CK.13.6	CK.18.3	CK.23.0	CK.27.7	CK.32.3
CK.13.7	CK.18.4	CK.23.1	CK.27.8	CK.32.4
CK.13.8	CK.18.5	CK.23.2	CK.27.9	CK.32.5
CK.13.9	CK.18.6	CK.23.3	CK.28.0	CK.32.6
CK.14.0	CK.18.7	CK.23.4	CK.28.1	CK.32.7
CK.14.1	CK.18.8	CK.23.5	CK.28.2	CK.32.8
CK.14.2	CK.18.9	CK.23.6	CK.28.3	CK.32.9
CK.14.3	CK.19.0	CK.23.7	CK.28.4	CK.33.0
CK.14.4	CK.19.1	CK.23.8	CK.28.5	CK.33.1
CK.14.5	CK.19.2	CK.23.9	CK.28.6	CK.33.2
CK.14.6	CK.19.3	CK.24.0	CK.28.7	CK.33.3
CK.14.7	CK.19.4	CK.24.1	CK.28.8	CK.33.4
CK.14.8	CK.19.5	CK.24.2	CK.28.9	CK.33.5
CK.14.9	CK.19.6	CK.24.3	CK.29.0	CK.33.6
CK.15.0	CK.19.7	CK.24.4	CK.29.1	CK.33.7
CK.15.1	CK.19.8	CK.24.5	CK.29.2	CK.33.8
CK.15.2	CK.19.9	CK.24.6	CK.29.3	CK.33.9
CK.15.3	CK.20.0	CK.24.7	CK.29.4	CK.34.0
CK.15.4	CK.20.1	CK.24.8	CK.29.5	CK.34.1
CK.15.5	CK.20.2	CK.24.9	CK.29.6	CK.34.2
CK.15.6	CK.20.3	CK.25.0	CK.29.7	CK.34.3
CK.15.7	CK.20.4	CK.25.1	CK.29.8	CK.34.4
CK.15.8	CK.20.5	CK.25.2	CK.29.9	CK.34.5
CK.15.9	CK.20.6	CK.25.3	CK.30.0	CK.34.6
CK.16.0	CK.20.7	CK.25.4	CK.30.1	CK.34.7
CK.16.1	CK.20.8	CK.25.5	CK.30.2	CK.34.8
CK.16.2	CK.20.9	CK.25.6	CK.30.3	CK.34.9
CK.16.3	CK.21.0	CK.25.7	CK.30.4	
CK.16.4	CK.21.1	CK.25.8	CK.30.5	
CK.16.5	CK.21.2	CK.25.9	CK.30.6	
CK.16.6	CK.21.3	CK.26.0	CK.30.7	

Refills for CK.35.0 through CK.39.0

\$1.75each, 3 of a size@\$1.25ea

CK.35.0	CK.35.7	CK.36.4	CK.37.1	CK.37.8
CK.35.1	CK.35.8	CK.36.5	CK.37.2	CK.37.9
CK.35.2	CK.35.9	CK.36.6	CK.37.3	CK.38.0
CK.35.3	CK.36.0	CK.36.7	CK.37.4	CK.38.5
CK.35.4	CK.36.1	CK.36.8	CK.37.5	CK.39.0
CK.35.5	CK.36.2	CK.36.9	CK.37.6	
CK.35.6	CK.36.3	CK.37.0	CK.37.7	

CAS-KER FLAT PLAIN MINERAL GLASS WATCH CRYSTALS

MGH 1.20 Flat

1.20mm thick, flat.
Refills \$3.25ea

MGH.15.0	MGH.20.0	MGH.25.0	MGH.30.0	MGH.35.5
MGH.15.5	MGH.20.5	MGH.25.5	MGH.30.5	MGH.36.0
MGH.16.0	MGH.21.0	MGH.26.0	MGH.31.0	MGH.36.5
MGH.16.5	MGH.21.5	MGH.26.5	MGH.31.5	MGH.37.0
MGH.17.0	MGH.22.0	MGH.27.0	MGH.32.0	MGH.37.5
MGH.17.5	MGH.22.5	MGH.27.5	MGH.32.5	MGH.38.0
MGH.18.0	MGH.23.0	MGH.28.0	MGH.33.0	MGH.38.5
MGH.18.5	MGH.23.5	MGH.28.5	MGH.33.5	MGH.39.0
MGH.19.0	MGH.24.0	MGH.29.0	MGH.34.0	MGH.39.5
MGH.19.5	MGH.24.5	MGH.29.5	MGH.34.5	MGH.40.0



MTK 1.50 Flat

900.028
900.029

1.50mm thick, flat.

900.028 29 pc Asst. 32-40mm \$54.95
900.029 29 pc Asst. 18-32 mm \$54.95

Refills

MTK.17.8 thru MTK.34.8 \$3.00ea
MTK.35.0 thru MTK.46.10 \$3.25ea

MTK.17.8	MTK.23.5	MTK.29.3	MTK.34.3	MTK.38.8
MTK.18.0	MTK.24.0	MTK.29.5	MTK.34.5	MTK.39.0
MTK.18.3	MTK.24.5	MTK.29.8	MTK.34.8	MTK.39.3
MTK.18.5	MTK.25.0	MTK.30.0		MTK.39.5
MTK.18.8	MTK.25.3	MTK.30.3	MTK.35.0	MTK.39.8
MTK.19.0	MTK.25.5	MTK.30.5	MTK.35.3	MTK.40.0
MTK.19.3	MTK.26.0	MTK.30.8	MTK.35.5	MTK.40.5
MTK.19.5	MTK.26.3	MTK.31.3	MTK.35.8	MTK.41.0
MTK.19.8	MTK.26.5	MTK.31.5	MTK.36.0	MTK.41.5
MTK.20.0	MTK.26.8	MTK.31.8	MTK.36.3	MTK.42.0
MTK.20.3	MTK.27.0	MTK.32.0	MTK.36.5	MTK.42.5
MTK.20.5	MTK.27.3	MTK.32.3	MTK.36.8	MTK.43.0
MTK.20.8	MTK.27.5	MTK.32.5	MTK.37.0	MTK.43.5
MTK.21.0	MTK.27.8	MTK.32.8	MTK.37.3	MTK.44.0
MTK.21.3	MTK.28.0	MTK.33.0	MTK.37.5	MTK.44.5
MTK.21.5	MTK.28.3	MTK.33.3	MTK.37.8	MTK.45.0
MTK.22.0	MTK.28.5	MTK.33.5	MTK.38.0	MTK.45.5
MTK.22.5	MTK.28.8	MTK.33.8	MTK.38.3	MTK.46.0
MTK.23.0	MTK.29.0	MTK.34.0	MTK.38.5	

TK 2.00 Flat

900.016
900.034

2.00mm thick, flat.

900.016 29 piece Assortment 18-32mm \$54.95

900.034 25 piece Assortment 32-40mm \$54.95

Refills TK.16.0 through TK.34.9 \$3.00ea

Refills TK.35.0 through TK.45.0 \$3.25ea

Refills TK.45.5 through TK.50.0 \$3.75ea

TK.16.0	TK.18.4	TK.20.8	TK.23.2	TK.25.6	TK.28.0	TK.30.4	TK.32.8	TK.35.1	TK.42.5
TK.16.1	TK.18.5	TK.20.9	TK.23.3	TK.25.7	TK.28.1	TK.30.5	TK.32.9	TK.35.2	TK.43.0
TK.16.2	TK.18.6	TK.21.0	TK.23.4	TK.25.8	TK.28.2	TK.30.6	TK.33.0	TK.35.3	TK.43.5
TK.16.3	TK.18.7	TK.21.1	TK.23.5	TK.25.9	TK.28.3	TK.30.7	TK.33.1	TK.35.4	TK.44.0
TK.16.4	TK.18.8	TK.21.2	TK.23.6	TK.26.0	TK.28.4	TK.30.8	TK.33.2	TK.35.5	TK.44.5
TK.16.5	TK.18.9	TK.21.3	TK.23.7	TK.26.1	TK.28.5	TK.30.9	TK.33.3	TK.35.6	TK.45.0
TK.16.6	TK.19.0	TK.21.4	TK.23.8	TK.26.2	TK.28.6	TK.31.0	TK.33.4	TK.35.7	
TK.16.7	TK.19.1	TK.21.5	TK.23.9	TK.26.3	TK.28.7	TK.31.1	TK.33.5	TK.35.8	TK.45.5
TK.16.8	TK.19.2	TK.21.6	TK.24.0	TK.26.4	TK.28.8	TK.31.2	TK.33.6	TK.35.9	TK.46.0
TK.16.9	TK.19.3	TK.21.7	TK.24.1	TK.26.5	TK.28.9	TK.31.3	TK.33.7	TK.36.0	TK.46.5
TK.17.0	TK.19.4	TK.21.8	TK.24.2	TK.26.6	TK.29.0	TK.31.4	TK.33.8	TK.36.5	TK.47.0
TK.17.1	TK.19.5	TK.21.9	TK.24.3	TK.26.7	TK.29.1	TK.31.5	TK.33.9	TK.37.0	TK.47.5
TK.17.2	TK.19.6	TK.22.0	TK.24.4	TK.26.8	TK.29.2	TK.31.6	TK.34.0	TK.37.3	TK.48.0
TK.17.3	TK.19.7	TK.22.1	TK.24.5	TK.26.9	TK.29.3	TK.31.7	TK.34.1	TK.37.5	TK.48.5
TK.17.4	TK.19.8	TK.22.2	TK.24.6	TK.27.0	TK.29.4	TK.31.8	TK.34.2	TK.37.8	TK.49.0
TK.17.5	TK.19.9	TK.22.3	TK.24.7	TK.27.1	TK.29.5	TK.31.9	TK.34.3	TK.38.0	TK.49.5
TK.17.6	TK.20.0	TK.22.4	TK.24.8	TK.27.2	TK.29.6	TK.32.0	TK.34.4	TK.38.5	TK.50.0
TK.17.7	TK.20.1	TK.22.5	TK.24.9	TK.27.3	TK.29.7	TK.32.1	TK.34.5	TK.39.0	
TK.17.8	TK.20.2	TK.22.6	TK.25.0	TK.27.4	TK.29.8	TK.32.2	TK.34.6	TK.39.5	
TK.17.9	TK.20.3	TK.22.7	TK.25.1	TK.27.5	TK.29.9	TK.32.3	TK.34.7	TK.40.0	
TK.18.0	TK.20.4	TK.22.8	TK.25.2	TK.27.6	TK.30.0	TK.32.4	TK.34.8	TK.40.5	
TK.18.1	TK.20.5	TK.22.9	TK.25.3	TK.27.7	TK.30.1	TK.32.5	TK.34.9	TK.41.0	
TK.18.2	TK.20.6	TK.23.0	TK.25.4	TK.27.8	TK.30.2	TK.32.6		TK.41.5	
TK.18.3	TK.20.7	TK.23.1	TK.25.5	TK.27.9	TK.30.3	TK.32.7	TK.35.0	TK.42.0	

CAS-KER FLAT PLAIN MINERAL GLASS WATCH CRYSTALS

VTK 2.50 Flat 900.017 900.027

2.50mm thick, flat.

900.017	29 piece Assortment 18-32mm	\$54.95
900.027	25 piece Assortment 32-40mm	\$54.95
	Refills VTK.17.0 through VTK.34.8	\$3.00ea
	Refills VTK.35.0 through VTK.45.5	\$3.25ea
	Refills VTK.46.0 through VTK.50.0	\$3.75ea

VTK.17.0	VTK.26.0	VTK.32.5	VTK.36.8	VTK.42.5
VTK.17.5	VTK.26.5	VTK.32.8	VTK.37.0	VTK.43.0
VTK.18.0	VTK.27.0	VTK.33.0	VTK.37.3	VTK.43.5
VTK.18.5	VTK.27.5	VTK.33.3	VTK.37.5	VTK.44.0
VTK.19.0	VTK.28.0	VTK.33.5	VTK.37.8	VTK.44.5
VTK.19.5	VTK.28.5	VTK.33.8	VTK.38.0	VTK.45.0
VTK.20.0	VTK.29.0	VTK.34.0	VTK.38.3	VTK.45.5
VTK.20.5	VTK.29.5	VTK.34.3	VTK.38.5	
VTK.21.0	VTK.30.0	VTK.34.5	VTK.38.8	VTK.46.0
VTK.21.5	VTK.30.3	VTK.34.8	VTK.39.0	VTK.46.5
VTK.22.0	VTK.30.5		VTK.39.3	VTK.47.0
VTK.22.5	VTK.30.8	VTK.35.0	VTK.39.5	VTK.47.5
VTK.23.0	VTK.31.0	VTK.35.3	VTK.39.8	VTK.48.0
VTK.23.5	VTK.31.3	VTK.35.5	VTK.40.0	VTK.48.5
VTK.24.0	VTK.31.5	VTK.35.8	VTK.40.5	VTK.49.0
VTK.24.5	VTK.31.8	VTK.36.0	VTK.41.0	VTK.49.5
VTK.25.0	VTK.32.0	VTK.36.3	VTK.41.5	VTK.50.0
VTK.25.5	VTK.32.3	VTK.36.5	VTK.42.0	

YTK 3.50 Flat 900.134

3.50mm thick, flat.

900.134	29 pc Asst 26-40mm	\$79.95
	Refills YTK.26.0 thru YTK.46.0	\$4.00ea
	Refills YTK.46.5 thru YTK.50.0	\$5.00ea

YTK.26.0	YTK.35.0	YTK.44.0
YTK.26.5	YTK.35.5	YTK.44.5
YTK.27.0	YTK.36.0	YTK.45.0
YTK.27.5	YTK.36.5	YTK.45.5
YTK.28.0	YTK.37.0	YTK.46.0
YTK.28.5	YTK.37.5	
YTK.29.0	YTK.38.0	YTK.46.5
YTK.29.5	YTK.38.5	YTK.47.0
YTK.30.0	YTK.39.0	YTK.47.5
YTK.30.5	YTK.39.5	YTK.48.0
YTK.31.0	YTK.40.0	YTK.48.5
YTK.31.5	YTK.40.5	YTK.49.0
YTK.32.0	YTK.41.0	YTK.49.5
YTK.32.5	YTK.41.5	YTK.50.0
YTK.33.0	YTK.42.0	
YTK.33.5	YTK.42.5	
YTK.34.0	YTK.43.0	
YTK.34.5	YTK.43.5	

XTK 3.00 Flat 900.019 900.033

3.00mm thick, flat.

900.019	29 piece Assortment 18-32mm	\$54.95
900.033	25 piece Assortment 32-40mm	\$54.95
	Refills XTK.18.0 through XTK.34.8	\$3.00ea
	Refills XTK.35.0 through XTK.46.0	\$3.25ea
	Refills XTK.46.5 through XTK.50.0	\$3.75ea

XTK.18.0	XTK.27.0	XTK.34.5	XTK.42.0
XTK.18.5	XTK.27.5	XTK.34.8	XTK.42.5
XTK.19.0	XTK.28.0		XTK.43.0
XTK.19.5	XTK.28.5	XTK.35.0	XTK.43.5
XTK.20.0	XTK.29.0	XTK.35.5	XTK.44.0
XTK.20.5	XTK.29.5	XTK.36.0	XTK.44.5
XTK.21.0	XTK.29.8	XTK.36.3	XTK.45.0
XTK.21.5	XTK.30.0	XTK.36.5	XTK.45.5
XTK.22.0	XTK.30.5	XTK.37.0	XTK.46.0
XTK.22.5	XTK.31.0	XTK.37.5	
XTK.23.0	XTK.31.3	XTK.38.0	XTK.46.5
XTK.23.5	XTK.31.5	XTK.38.5	XTK.47.0
XTK.24.0	XTK.32.0	XTK.39.0	XTK.47.5
XTK.24.5	XTK.32.5	XTK.39.5	XTK.48.0
XTK.25.0	XTK.33.0	XTK.40.0	XTK.48.5
XTK.25.5	XTK.33.3	XTK.40.5	XTK.49.0
XTK.26.0	XTK.33.5	XTK.41.0	XTK.49.5
XTK.26.5	XTK.34.0	XTK.41.5	XTK.50.0

ZTK 4.00 Flat 900.135

4.00mm thick, flat.

900.135	29 pc Asst 26-40mm	\$79.95
	Refills ZTK.26.0 thru ZTK.46.0	\$4.00ea
	Refills ZTK.46.5 thru ZTK.50.0	\$5.00ea

ZTK.26.0	ZTK.35.0	ZTK.44.0
ZTK.26.5	ZTK.35.5	ZTK.44.5
ZTK.27.0	ZTK.36.0	ZTK.45.0
ZTK.27.5	ZTK.36.5	ZTK.45.5
ZTK.28.0	ZTK.37.0	ZTK.46.0
ZTK.28.5	ZTK.37.5	ZTK.46.5
ZTK.29.0	ZTK.38.0	ZTK.47.0
ZTK.29.5	ZTK.38.5	ZTK.47.5
ZTK.30.0	ZTK.39.0	ZTK.48.0
ZTK.30.5	ZTK.39.5	ZTK.48.5
ZTK.31.0	ZTK.40.0	ZTK.49.0
ZTK.31.5	ZTK.40.5	ZTK.49.5
ZTK.32.0	ZTK.41.0	ZTK.50.0
ZTK.32.5	ZTK.41.5	
ZTK.33.0	ZTK.42.0	
ZTK.33.5	ZTK.42.5	
ZTK.34.0	ZTK.43.0	
ZTK.34.5	ZTK.43.5	

Crystal Presses - page 86
Crystal Lifts - page 94
Crystal Adhesives - page 263

CAS-KER DOMED PLAIN MINERAL GLASS WATCH CRYSTALS



RCK 1.00 Dome 900.024 900.018

0.90mm or 1.00 mm thick, domed.

900.024 24 piece Assortment 18-31mm **\$54.95**

900.018 30 piece Assortment 31.5-46mm **\$69.95**

Refills RCK.14.0 through RCK.34.9 **\$3.00 each, 3 of a size \$2.60 each**

Refills RCK.35.0 through RCK.46.0 **\$3.25 each, 3 of a size \$2.75 each**

RCK.14.0	RCK.16.9	RCK.19.8	RCK.22.7	RCK.25.6	RCK.28.5	RCK.31.4	RCK.34.3	RCK.37.8	RCK.42.6
RCK.14.1	RCK.17.0	RCK.19.9	RCK.22.8	RCK.25.7	RCK.28.6	RCK.31.5	RCK.34.4	RCK.38.0	RCK.42.8
RCK.14.2	RCK.17.1	RCK.20.0	RCK.22.9	RCK.25.8	RCK.28.7	RCK.31.6	RCK.34.5	RCK.38.2	RCK.43.0
RCK.14.3	RCK.17.2	RCK.20.1	RCK.23.0	RCK.25.9	RCK.28.8	RCK.31.7	RCK.34.6	RCK.38.4	RCK.43.2
RCK.14.4	RCK.17.3	RCK.20.2	RCK.23.1	RCK.26.0	RCK.28.9	RCK.31.8	RCK.34.7	RCK.38.5	RCK.43.4
RCK.14.5	RCK.17.4	RCK.20.3	RCK.23.2	RCK.26.1	RCK.29.0	RCK.31.9	RCK.34.8	RCK.38.6	RCK.43.5
RCK.14.6	RCK.17.5	RCK.20.4	RCK.23.3	RCK.26.2	RCK.29.1	RCK.32.0	RCK.34.9	RCK.38.8	RCK.43.6
RCK.14.7	RCK.17.6	RCK.20.5	RCK.23.4	RCK.26.3	RCK.29.2	RCK.32.1		RCK.39.0	RCK.43.8
RCK.14.8	RCK.17.7	RCK.20.6	RCK.23.5	RCK.26.4	RCK.29.3	RCK.32.2	RCK.35.0	RCK.39.2	RCK.44.0
RCK.14.9	RCK.17.8	RCK.20.7	RCK.23.6	RCK.26.5	RCK.29.4	RCK.32.3	RCK.35.1	RCK.39.4	RCK.44.2
RCK.15.0	RCK.17.9	RCK.20.8	RCK.23.7	RCK.26.6	RCK.29.5	RCK.32.4	RCK.35.2	RCK.39.5	RCK.44.4
RCK.15.1	RCK.18.0	RCK.20.9	RCK.23.8	RCK.26.7	RCK.29.6	RCK.32.5	RCK.35.3	RCK.39.6	RCK.44.5
RCK.15.2	RCK.18.1	RCK.21.0	RCK.23.9	RCK.26.8	RCK.29.7	RCK.32.6	RCK.35.4	RCK.39.8	RCK.44.6
RCK.15.3	RCK.18.2	RCK.21.1	RCK.24.0	RCK.26.9	RCK.29.8	RCK.32.7	RCK.35.5	RCK.40.0	RCK.44.8
RCK.15.4	RCK.18.3	RCK.21.2	RCK.24.1	RCK.27.0	RCK.29.9	RCK.32.8	RCK.35.6	RCK.40.2	RCK.45.0
RCK.15.5	RCK.18.4	RCK.21.3	RCK.24.2	RCK.27.1	RCK.30.0	RCK.32.9	RCK.35.7	RCK.40.4	RCK.45.2
RCK.15.6	RCK.18.5	RCK.21.4	RCK.24.3	RCK.27.2	RCK.30.1	RCK.33.0	RCK.35.8	RCK.40.5	RCK.45.4
RCK.15.7	RCK.18.6	RCK.21.5	RCK.24.4	RCK.27.3	RCK.30.2	RCK.33.1	RCK.35.9	RCK.40.6	RCK.45.5
RCK.15.8	RCK.18.7	RCK.21.6	RCK.24.5	RCK.27.4	RCK.30.3	RCK.33.2	RCK.36.0	RCK.40.8	RCK.45.6
RCK.15.9	RCK.18.8	RCK.21.7	RCK.24.6	RCK.27.5	RCK.30.4	RCK.33.3	RCK.36.2	RCK.41.0	RCK.45.8
RCK.16.0	RCK.18.9	RCK.21.8	RCK.24.7	RCK.27.6	RCK.30.5	RCK.33.4	RCK.36.4	RCK.41.2	RCK.46.0
RCK.16.1	RCK.19.0	RCK.21.9	RCK.24.8	RCK.27.7	RCK.30.6	RCK.33.5	RCK.36.5	RCK.41.4	
RCK.16.2	RCK.19.1	RCK.22.0	RCK.24.9	RCK.27.8	RCK.30.7	RCK.33.6	RCK.36.6	RCK.41.5	
RCK.16.3	RCK.19.2	RCK.22.1	RCK.25.0	RCK.27.9	RCK.30.8	RCK.33.7	RCK.36.8	RCK.41.6	
RCK.16.4	RCK.19.3	RCK.22.2	RCK.25.1	RCK.28.0	RCK.30.9	RCK.33.8	RCK.37.0	RCK.41.8	
RCK.16.5	RCK.19.4	RCK.22.3	RCK.25.2	RCK.28.1	RCK.31.0	RCK.33.9	RCK.37.2	RCK.42.0	
RCK.16.6	RCK.19.5	RCK.22.4	RCK.25.3	RCK.28.2	RCK.31.1	RCK.34.0	RCK.37.4	RCK.42.2	
RCK.16.7	RCK.19.6	RCK.22.5	RCK.25.4	RCK.28.3	RCK.31.2	RCK.34.1	RCK.37.5	RCK.42.4	
RCK.16.8	RCK.19.7	RCK.22.6	RCK.25.5	RCK.28.4	RCK.31.3	RCK.34.2	RCK.37.6	RCK.42.5	

MTD 1.50 Dome 900.042

1.50mm thick, domed.

900.042 29 piece Assortment 26-40mm **\$69.95**

Refills MTD.26.0 through MTD.34.5 **\$3.25 each**

Refills MTD.35.0 through MTD.40.0 **\$3.50 each**

MTD.26.0	MTD.27.5	MTD.29.0	MTD.30.5	MTD.32.0	MTD.33.5	MTD.35.0	MTD.36.5	MTD.38.0	MTD.39.5
MTD.26.5	MTD.28.0	MTD.29.5	MTD.31.0	MTD.32.5	MTD.34.0	MTD.35.5	MTD.37.0	MTD.38.5	MTD.40.0
MTD.27.0	MTD.28.5	MTD.30.0	MTD.31.5	MTD.33.0	MTD.34.5	MTD.36.0	MTD.37.5	MTD.39.0	

TD 2.00 Dome 900.040

2.00mm thick, domed.

900.040 29 piece Assortment 26-40mm **\$69.95**

Refills TD.26.0 through TD.34.5 **\$3.25 each**

Refills TD.35.0 through TD.40.0 **\$3.50 each**

TD.26.0	TD.27.5	TD.29.0	TD.30.5	TD.32.0	TD.33.5	TD.35.0	TD.36.5	TD.38.0	TD.39.5
TD.26.5	TD.28.0	TD.29.5	TD.31.0	TD.32.5	TD.34.0	TD.35.5	TD.37.0	TD.38.5	TD.40.0
TD.27.0	TD.28.5	TD.30.0	TD.31.5	TD.33.0	TD.34.5	TD.36.0	TD.37.5	TD.39.0	

XTD 3.00 Dome 900.041

3.00mm thick, domed.

900.041 29 piece Assortment 26-40mm **\$69.95**

Refills XTD.26.0 through XTD.34.5 **\$3.50 each**

Refills XTD.35.0 through XTD.40.0 **\$4.50 each**

XTD.26.0	XTD.27.5	XTD.29.0	XTD.30.5	XTD.32.0	XTD.33.5	XTD.35.0	XTD.36.5	XTD.38.0	XTD.39.5
XTD.26.5	XTD.28.0	XTD.29.5	XTD.31.0	XTD.32.5	XTD.34.0	XTD.35.5	XTD.37.0	XTD.38.5	XTD.40.0
XTD.27.0	XTD.28.5	XTD.30.0	XTD.31.5	XTD.33.0	XTD.34.5	XTD.36.0	XTD.37.5	XTD.39.0	

CAS-KER SAPPHIRE GLASS WATCH CRYSTALS

SAPH 0.80 Flat

0.80mm thick, flat, Sapphire.
 SAPH.15.0 thru SAPH.18.9 \$16.00ea
 SAPH.19.0 thru SAPH.21.5 \$17.00ea
 SAPH.21.6 thru SAPH.23.9 \$18.00ea
 SAPH.24.0 thru SAPH.32.0 \$19.00ea

SAPH.15.0	SAPH.18.4	SAPH.21.6	SAPH.24.9	SAPH.28.3
SAPH.15.1	SAPH.18.5	SAPH.21.7	SAPH.25.0	SAPH.28.4
SAPH.15.2	SAPH.18.6	SAPH.21.8	SAPH.25.1	SAPH.28.5
SAPH.15.3	SAPH.18.7	SAPH.21.9	SAPH.25.2	SAPH.28.6
SAPH.15.4	SAPH.18.8	SAPH.22.0	SAPH.25.3	SAPH.28.7
SAPH.15.5	SAPH.18.9	SAPH.22.1	SAPH.25.4	SAPH.28.8
SAPH.15.6		SAPH.22.2	SAPH.25.5	SAPH.28.9
SAPH.15.7	SAPH.19.0	SAPH.22.3	SAPH.25.6	SAPH.29.0
SAPH.15.8	SAPH.19.1	SAPH.22.4	SAPH.25.7	SAPH.29.1
SAPH.15.9	SAPH.19.2	SAPH.22.5	SAPH.25.8	SAPH.29.2
SAPH.16.0	SAPH.19.3	SAPH.22.6	SAPH.25.9	SAPH.29.3
SAPH.16.1	SAPH.19.4	SAPH.22.7	SAPH.26.0	SAPH.29.4
SAPH.16.2	SAPH.19.5	SAPH.22.8	SAPH.26.1	SAPH.29.5
SAPH.16.3	SAPH.19.6	SAPH.22.9	SAPH.26.2	SAPH.29.6
SAPH.16.4	SAPH.19.7	SAPH.23.0	SAPH.26.3	SAPH.29.7
SAPH.16.5	SAPH.19.8	SAPH.23.1	SAPH.26.4	SAPH.29.8
SAPH.16.6	SAPH.19.9	SAPH.23.2	SAPH.26.5	SAPH.29.9
SAPH.16.7	SAPH.20.0	SAPH.23.3	SAPH.26.6	SAPH.30.0
SAPH.16.8	SAPH.20.1	SAPH.23.4	SAPH.26.7	SAPH.30.1
SAPH.16.9	SAPH.20.2	SAPH.23.5	SAPH.26.8	SAPH.30.2
SAPH.17.0	SAPH.20.3	SAPH.23.6	SAPH.26.9	SAPH.30.3
SAPH.17.1	SAPH.20.4	SAPH.23.7	SAPH.27.0	SAPH.30.4
SAPH.17.2	SAPH.20.5	SAPH.23.8	SAPH.27.1	SAPH.30.5
SAPH.17.3	SAPH.20.6	SAPH.23.9	SAPH.27.2	SAPH.30.6
SAPH.17.4	SAPH.20.7		SAPH.27.3	SAPH.30.7
SAPH.17.5	SAPH.20.8	SAPH.24.0	SAPH.27.4	SAPH.30.8
SAPH.17.6	SAPH.20.9	SAPH.24.1	SAPH.27.5	SAPH.30.9
SAPH.17.7	SAPH.21.0	SAPH.24.2	SAPH.27.6	SAPH.31.0
SAPH.17.8	SAPH.21.1	SAPH.24.3	SAPH.27.7	SAPH.31.5
SAPH.17.9	SAPH.21.2	SAPH.24.4	SAPH.27.8	SAPH.32.0
SAPH.18.0	SAPH.21.3	SAPH.24.5	SAPH.27.9	
SAPH.18.1	SAPH.21.4	SAPH.24.6	SAPH.28.0	
SAPH.18.2	SAPH.21.5	SAPH.24.7	SAPH.28.1	
SAPH.18.3		SAPH.24.8	SAPH.28.2	

TSAPH Var. Thicknesses Flat

Various thicknesses, Sapphire.
 TSAPH.19.0 thru TSAPH.28.0
 \$30.00ea

TSAPH.19.0	2.50mm	TSAPH.25.0	2.00mm
TSAPH.19.5	2.00mm	TSAPH.26.0	1.80mm
TSAPH.23.5	1.80mm	TSAPH.27.5	2.85mm
TSAPH.24.0	2.00mm	TSAPH.28.0	2.00mm

Generic Sapphire Crystals to fit RLX

Gasket included with each sapphire crystal.

ROL.172C	\$20.95	ROL.286	\$30.95
ROL.185	\$20.95	ROL.286C	\$30.95
ROL.192	\$25.95	ROL.295C	\$25.95
ROL.200C	\$20.95	ROL.295C-2 high gasket	\$30.95
ROL.206C	\$20.95	ROL.318C	\$29.95
ROL.246C	\$30.95	300P Ladies' Parabolic	\$49.95
ROL.269C	\$25.95	500P Gents Parabolic	\$49.95
ROL.282C	\$25.95		

CKES 1.00 Flat 900.049

1.00mm thick, flat economy Sapphire.
 900.049 8 pc Asst. 18-30mm \$52.95
 CKES.13.0 thru CKES.25.5 \$8.75ea
 CKES.26.0 thru CKES.31.5 \$10.75ea
 CKES.32.0 thru CKES.33.5 \$14.00ea
 CKES.34.0 thru CKES.35.0 \$17.00ea

CKES.13.0	CKES.19.0	CKES.25.0	CKES.30.5
CKES.13.5	CKES.19.5	CKES.25.5	CKES.31.0
CKES.14.0	CKES.20.0		CKES.31.5
CKES.14.5	CKES.20.5	CKES.26.0	
CKES.15.0	CKES.21.0	CKES.26.5	CKES.32.0
CKES.15.5	CKES.21.5	CKES.27.0	CKES.32.5
CKES.16.0	CKES.22.0	CKES.27.5	CKES.33.0
CKES.16.5	CKES.22.5	CKES.28.0	CKES.33.5
CKES.17.0	CKES.23.0	CKES.28.5	
CKES.17.5	CKES.23.5	CKES.29.0	CKES.34.0
CKES.18.0	CKES.24.0	CKES.29.5	CKES.34.5
CKES.18.5	CKES.24.5	CKES.30.0	CKES.35.0

SAPHM 1.50 Flat

1.50mm thick, flat Sapphire.
 SAPHM.16.0 thru SAPHM.28.0 \$16.00ea
 SAPHM.28.5 thru SAPHM.31.0 \$17.00ea
 SAPHM.31.5 thru SAPHM.34.0 \$18.00ea
 SAPHM.34.5 thru SAPHM.35.0 \$19.00ea
 SAPHM.35.5 thru SAPHM.36.0 \$22.00ea
 SAPHM.36.5 thru SAPHM.37.0 \$24.00ea
 SAPHM.37.5 thru SAPHM.38.0 \$30.00ea

SAPHM.16.0	SAPHM.22.5	SAPHM.28.5	
SAPHM.16.5	SAPHM.23.0	SAPHM.29.0	SAPHM.34.5
SAPHM.17.0	SAPHM.23.5	SAPHM.29.5	SAPHM.35.0
SAPHM.17.5	SAPHM.24.0	SAPHM.30.0	
SAPHM.18.0	SAPHM.24.5	SAPHM.30.5	SAPHM.35.5
SAPHM.18.5	SAPHM.25.0	SAPHM.31.0	SAPHM.36.0
SAPHM.19.0	SAPHM.25.5		
SAPHM.19.5	SAPHM.26.0	SAPHM.31.5	SAPHM.36.5
SAPHM.20.0	SAPHM.26.5	SAPHM.32.0	SAPHM.37.0
SAPHM.20.5	SAPHM.27.0	SAPHM.32.5	
SAPHM.21.0	SAPHM.27.5	SAPHM.33.0	SAPHM.37.5
SAPHM.21.5	SAPHM.28.0	SAPHM.33.5	SAPHM.38.0
SAPHM.22.0		SAPHM.34.0	

SSAPH 0.80 Flat

0.80mm thick, flat Sapphire, 3.5 mm silver edge.
 SSAPH.35.0 \$40.00ea

DSAPHM 0.90 Domed

0.90mm thick, domed Sapphire.
 DSAPH.20.0 thru DSAPH.26.0 \$34.00ea
 DSAPH.26.5 thru DSAPH.28.5 \$37.00ea
 DSAPH.29.0 thru DSAPH.29.5 \$41.00ea
 DSAPH.30.0 thru DSAPH.34.5 \$44.50ea

DSAPH.20.0			DSAPH.31.0
DSAPH.24.0	DSAPH.26.5	DSAPH.29.0	DSAPH.31.5
DSAPH.24.5	DSAPH.27.0	DSAPH.29.5	DSAPH.32.0
DSAPH.25.0	DSAPH.27.5		DSAPH.32.5
DSAPH.25.5	DSAPH.28.0	DSAPH.30.0	DSAPH.33.0
DSAPH.26.0	DSAPH.28.5	DSAPH.30.5	DSAPH.34.5

CAS-KER FLAT FANCY GLASS WATCH CRYSTALS

BF Flat		0.80mm thick, flat. Narrow black trim 1.0mm. Limited Supply. \$6.95 each		
BF.18.0	BF.21.0	BF.24.0	BF.28.0	BF.31.5
BF.18.5	BF.21.5	BF.24.5	BF.28.5	BF.32.0
BF.19.0	BF.22.0	BF.25.0	BF.29.0	
BF.19.5	BF.22.5	BF.26.5	BF.29.5	
BF.20.0	BF.23.0	BF.27.0	BF.30.0	
BF.20.5	BF.23.5	BF.27.5	BF.30.5	

SE Flat		1.00mm thick, flat. Wide silver trim 3.0mm. \$6.95 each, 3 of a size \$6.00 each		
SE.24.0	SE.26.5	SE.29.0	SE.31.5	SE.34.0
SE.24.5	SE.27.0	SE.29.5	SE.32.0	SE.34.5
SE.25.0	SE.27.5	SE.30.0	SE.32.5	SE.35.0
SE.25.5	SE.28.0	SE.30.5	SE.33.0	
SE.26.0	SE.28.5	SE.31.0	SE.33.5	

BFT Flat		0.80mm thick, flat. Wide black trim 3.5mm. \$6.95 each		
BFT.19.0	BFT.22.0	BFT.25.0	BFT.28.0	BFT.31.0
BFT.19.5	BFT.22.5	BFT.25.5	BFT.28.5	BFT.31.5
BFT.20.0	BFT.23.0	BFT.26.0	BFT.29.0	BFT.32.0
BFT.20.5	BFT.23.5	BFT.26.5	BFT.29.5	BFT.32.5
BFT.21.0	BFT.24.0	BFT.27.0	BFT.30.0	
BFT.21.5	BFT.24.5	BFT.27.5	BFT.30.5	

XIIG Flat		1.00mm thick, flat. Gold trim, black Roman 3.5mm. \$6.95 each, 3 of a size \$6.00 each		
XIIG.18.0	XIIG.21.0	XIIG.24.0	XIIG.27.0	XIIG.30.0
XIIG.18.5	XIIG.21.5	XIIG.24.5	XIIG.27.5	XIIG.30.5
XIIG.19.0	XIIG.22.0	XIIG.25.0	XIIG.28.0	XIIG.31.0
XIIG.19.5	XIIG.22.5	XIIG.25.5	XIIG.28.5	XIIG.31.5
XIIG.20.0	XIIG.23.0	XIIG.26.0	XIIG.29.0	XIIG.32.0
XIIG.20.5	XIIG.23.5	XIIG.26.5	XIIG.29.5	

GE Flat		1.00mm thick, flat. Narrow gold trim 1.0mm. \$7.95 each		
GE.16.0	GE.19.5	GE.23.0	GE.26.5	GE.30.0
GE.16.5	GE.20.0	GE.23.5	GE.27.0	GE.30.5
GE.17.0	GE.20.5	GE.24.0	GE.27.5	GE.31.0
GE.17.5	GE.21.0	GE.24.5	GE.28.0	GE.31.5
GE.18.0	GE.21.5	GE.25.0	GE.28.5	GE.32.0
GE.18.5	GE.22.0	GE.25.5	GE.29.0	
GE.19.0	GE.22.5	GE.26.0	GE.29.5	

GET Flat		1.00mm thick, flat. Wide gold trim 3.5mm. \$6.95 each, 3 of a size \$6.00 each		
GET.16.0	GET.19.5	GET.23.0	GET.26.5	GET.30.0
GET.16.5	GET.20.0	GET.23.5	GET.27.0	GET.30.5
GET.17.0	GET.20.5	GET.24.0	GET.27.5	GET.31.0
GET.17.5	GET.21.0	GET.24.5	GET.28.0	GET.31.5
GET.18.0	GET.21.5	GET.25.0	GET.28.5	GET.32.0
GET.18.5	GET.22.0	GET.25.5	GET.29.0	
GET.19.0	GET.22.5	GET.26.0	GET.29.5	

CAS-KER MAGNIFYING CRYSTALS

MGM 1.00		Domed top, flat bottom. Magnifying, 1.00mm edge thickness. \$6.95 each, 3 of a size \$6.00 each	
MGM.18.0	MGM.24.0	MGM.30.0	MGM.36.0
MGM.18.5	MGM.24.5	MGM.30.5	MGM.36.5
MGM.19.0	MGM.25.0	MGM.31.0	MGM.37.0
MGM.19.5	MGM.25.5	MGM.31.5	MGM.37.5
MGM.20.0	MGM.26.0	MGM.32.0	MGM.38.0
MGM.20.5	MGM.26.5	MGM.32.5	MGM.38.5
MGM.21.0	MGM.27.0	MGM.33.0	MGM.39.0
MGM.21.5	MGM.27.5	MGM.33.5	MGM.39.5
MGM.22.0	MGM.28.0	MGM.34.0	MGM.40.0
MGM.22.5	MGM.28.5	MGM.34.5	
MGM.23.0	MGM.29.0	MGM.35.0	
MGM.23.5	MGM.29.5	MGM.35.5	

TMGM 2.00		Domed top, flat bottom. Magnifying, 2.00mm edge thickness. \$6.95 each, 3 of a size \$6.00 each	
TMGM.24.0	TMGM.28.5	TMGM.33.0	TMGM.37.5
TMGM.24.5	TMGM.29.0	TMGM.33.5	TMGM.38.0
TMGM.25.0	TMGM.29.5	TMGM.34.0	TMGM.38.5
TMGM.25.5	TMGM.30.0	TMGM.34.5	TMGM.39.0
TMGM.26.0	TMGM.30.5	TMGM.35.0	TMGM.39.5
TMGM.26.5	TMGM.31.0	TMGM.35.5	TMGM.40.0
TMGM.27.0	TMGM.31.5	TMGM.36.0	
TMGM.27.5	TMGM.32.0	TMGM.36.5	
TMGM.28.0	TMGM.32.5	TMGM.37.0	

MMGM 1.50		Domed top, flat bottom. Magnifying, 1.50mm edge thickness. \$6.95 each, 3 of a size \$6.00 each	
MMGM.20.0	MMGM.25.5	MMGM.30.5	MMGM.35.5
MMGM.21.0	MMGM.26.0	MMGM.31.0	MMGM.36.0
MMGM.21.5	MMGM.26.5	MMGM.31.5	MMGM.36.5
MMGM.22.0	MMGM.27.0	MMGM.32.0	MMGM.37.0
MMGM.22.5	MMGM.27.5	MMGM.32.5	MMGM.37.5
MMGM.23.0	MMGM.28.0	MMGM.33.0	MMGM.38.0
MMGM.23.5	MMGM.28.5	MMGM.33.5	MMGM.38.5
MMGM.24.0	MMGM.29.0	MMGM.34.0	MMGM.39.0
MMGM.24.5	MMGM.29.5	MMGM.34.5	MMGM.39.5
MMGM.25.0	MMGM.30.0	MMGM.35.0	MMGM.40.0

ZMGM 3.00		Domed top, flat bottom. Magnifying, 3.00mm edge thickness. \$6.95 each, 3 of a size \$6.00 each	
ZMGM.27.0	ZMGM.30.5	ZMGM.34.0	ZMGM.37.5
ZMGM.27.5	ZMGM.31.0	ZMGM.34.5	ZMGM.38.0
ZMGM.28.0	ZMGM.31.5	ZMGM.35.0	ZMGM.38.5
ZMGM.28.5	ZMGM.32.0	ZMGM.35.5	ZMGM.39.0
ZMGM.29.0	ZMGM.32.5	ZMGM.36.0	ZMGM.39.5
ZMGM.29.5	ZMGM.33.0	ZMGM.36.5	ZMGM.40.0
ZMGM.30.0	ZMGM.33.5	ZMGM.37.0	

CAS-KER DOMED FANCY GLASS WATCH CRYSTALS

BD				
1.00mm thick, domed, black trim 3.5mm. \$6.95ea				
BD.19.5	BD.22.5	BD.25.5	BD.28.5	BD.31.5
BD.20.0	BD.23.0	BD.26.0	BD.29.0	BD.32.0
BD.20.5	BD.23.5	BD.26.5	BD.29.5	BD.32.5
BD.21.0	BD.24.0	BD.27.0	BD.30.0	BD.33.0
BD.21.5	BD.24.5	BD.27.5	BD.30.5	BD.33.5
BD.22.0	BD.25.0	BD.28.0	BD.31.0	BD.34.0

GED				
0.90mm thick, domed, gold trim 3.0-4.0mm. \$6.95ea				
GED.19.5	GED.22.0	GED.24.5	GED.27.0	GED.29.5
GED.20.0	GED.22.5	GED.25.0	GED.27.5	GED.30.0
GED.20.5	GED.23.0	GED.25.5	GED.28.0	GED.30.5
GED.21.0	GED.23.5	GED.26.0	GED.28.5	GED.31.0
GED.21.5	GED.24.0	GED.26.5	GED.29.0	

SED				
1.00mm thick, domed, silver trim 1.0mm. \$6.95ea				
	SED.24.0	SED.28.0	SED.32.0	
	SED.24.5	SED.28.5	SED.32.5	
	SED.25.0	SED.29.0	SED.33.0	
	SED.25.5	SED.29.5	SED.33.5	
	SED.26.0	SED.30.0	SED.34.0	
	SED.26.5	SED.30.5	SED.34.5	
	SED.27.0	SED.31.0	SED.35.0	
	SED.27.5	SED.31.5		

XIIBD				
1.00mm thick, domed, black trim 2.0-4.0 with gold Roman numerals. \$6.95ea				
XIIBD.18.0	XIIBD.21.0	XIIBD.24.0	XIIBD.27.0	XIIBD.30.0
XIIBD.18.5	XIIBD.21.5	XIIBD.24.5	XIIBD.27.5	XIIBD.30.5
XIIBD.19.0	XIIBD.22.0	XIIBD.25.0	XIIBD.28.0	XIIBD.31.0
XIIBD.19.5	XIIBD.22.5	XIIBD.25.5	XIIBD.28.5	XIIBD.31.5
XIIBD.20.0	XIIBD.23.0	XIIBD.26.0	XIIBD.29.0	XIIBD.32.0
XIIBD.20.5	XIIBD.23.5	XIIBD.26.5	XIIBD.29.5	XIIBD.32.5

XIIGD				
1.00mm thick, domed, gold trim 2.5-4.5 with black Roman numerals. \$6.95ea				
XIIGD.18.0	XIIGD.21.5	XIIGD.25.0	XIIGD.28.5	XIIGD.32.0
XIIGD.18.5	XIIGD.22.0	XIIGD.25.5	XIIGD.29.0	XIIGD.32.5
XIIGD.19.0	XIIGD.22.5	XIIGD.26.0	XIIGD.29.5	XIIGD.33.0
XIIGD.19.5	XIIGD.23.0	XIIGD.26.5	XIIGD.30.0	
XIIGD.20.0	XIIGD.23.5	XIIGD.27.0	XIIGD.30.5	
XIIGD.20.5	XIIGD.24.0	XIIGD.27.5	XIIGD.31.0	
XIIGD.21.0	XIIGD.24.5	XIIGD.28.0	XIIGD.31.5	

CAS-KER MAGNIFIERS

Cas-Ker Glass Magnifiers

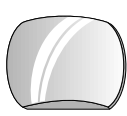

Rectangle	DIAMETERS	\$ Each	3@	10@
900.120	MAG 0 Ladies' 4.5 x 3.5	\$3.25	\$2.75	\$2.25
900.121	MAG 1 Ladies' 5.5 x 4.5	\$3.25	\$2.75	\$2.25
900.122	MAG 2 Men's 7.0 x 5.5	\$3.25	\$2.75	\$2.25

Sapphire	DIAMETERS	\$ Each	3@	10@
900.123	4.5 x 5.5	\$7.95	\$7.00	
900.124	7.0 x 5.5	\$7.95	\$7.00	

Bullet	DIAMETERS	\$ Each	3@	10@
900.131.01	7.0 x 6.0	\$2.95	\$2.75	\$2.50
900.131.02	10.4 x 7.6	\$2.95	\$2.75	\$2.50
900.131.03	11.3 x 7.0	\$2.95	\$2.75	\$2.50

Round	DIAMETERS	\$ Each	3@	10@
900.130.01	3.5	\$2.95	\$2.75	\$2.50
900.130.02	4.0	\$2.95	\$2.75	\$2.50
900.130.03	4.5	\$2.95	\$2.75	\$2.50
900.130.04	5.0	\$2.95	\$2.75	\$2.50
900.130.05	5.5	\$2.95	\$2.75	\$2.50
900.130.06	6.0	\$2.95	\$2.75	\$2.50
900.130.07	6.5	\$2.95	\$2.75	\$2.50

Domed Mineral Glass Blanks



Round Flat	Thick	Dimension	Each
900.125.10	0.70	30.0	\$1.50
900.125.12	0.80	30.0	\$1.50
900.125.14	1.00	30.0	\$1.50
900.125.16	0.70	40.0	\$1.50
900.125.18	0.80	40.0	\$1.50
900.125.20	1.00	40.0	\$1.50
900.125.21	0.90	40.0	\$1.50
900.125.22	1.30	40.0	\$1.50

Round Domed	Thick	Dimension	Each
900.125.40	2.00	40.0	\$5.00
900.125.41	1.00	40.0	\$5.00

Square Curved Top Flat Bottom	Thick	Dimension	Each
900.126.03	3.45	32.8 x 32.8	\$5.00
900.126.04	2.60	30.9 x 30.9	\$5.00
900.126.05	2.70	25.5 x 25.5	\$5.00
900.126.06	3.20	30.0 x 30.0	\$5.00
900.126.07	4.30	29.1 x 29.1	\$5.00

Rectangle Curved	Thick	L x W x H	Each
900.127.00	1.0	30.0 x 40.0 x 2.60	\$5.00
900.127.01	1.0	30.0 x 40.0 x 3.00	\$5.00
900.127.02	1.0	30.0 x 40.0 x 3.60	\$5.00
900.127.03	1.0	30.0 x 40.0 x 5.00	\$5.00
900.127.04	1.0	30.0 x 40.0 x 6.00	\$5.00

G-S Plastic Crystals

No.	Description	Order By	mm Diam.	Price
AT	Angle-Tite Flat Top Angles Side w/ White or Yellow Rings	mm size	15.0 - 35.0	\$9.75
BT	Bubble-Tite Magnifies	mm size	20.0 - 34.2	\$4.75
CDE	Diamond Edge .10mm increment	mm size	8.4 - 20.4	\$6.50
CDE	Diamond Edge .20mm increment	mm size	20.6 - 34.6	\$6.50
CFT	Flat Top Curved Inside	mm size	8.4 - 20.3	\$6.50
CT	Curv-Tite Slight Dome w/Polished Beveled Edge- (even sizes only, 0.2mm increments - not the same as Cylinder CT Crystal)	mm size	18.0 - 36.0	\$10.50
DT	Diver-Tite Double thick Waterproof w/White & Yellow Rings	mm size	24.5 - 34.9	\$8.75
ET	Ever-Tite Waterproof w/White or Yellow Ring - specify color	mm size & color	15.0 - 36.0	\$6.00
EW	Extra Wide Ring Ring Only - fits all G-S style ring crystals	mm size	14.0 - 35.0	\$6.25
FC	Flat Fancy Curved Sides	G-S Stock Number		\$7.50
FF	Flat Fancy Fancy - Irregular Shape	G-S Stock Number		\$7.50
FH	Flat Fancy Hexagon - 6 sides	G-S Stock Number		\$7.50
FO	Flat Fancy Oval	G-S Stock Number		\$7.50
FR	Flat Fancy Rounded Corners	G-S Stock Number		\$7.50
FX	Flat Fancy Rectangle	G-S Stock Number		\$7.50
FY	Flat Fancy Rounded; Top-Botton; Sides; or Both	G-S Stock Number		\$7.50
HC	Hunting Case	G-S Stock Number	22.2 - 45.7	\$7.50
KT	Kleer-Tite Clear for thin round watches	G-S Stock Number	14.6 - 33.0	\$6.75
MT	Magni-Tite Magnifier -Waterproof w/White & Yellow Rings (order by mm size & distance from center post)	mm size	27.5 - 35.0	\$8.75
PA	Waterproof	G-S Stock Number		\$9.75
PHD	Hi-Dome with Step	G-S Stock Number	8.4 - 40.0mm	\$4.00
PK	Lo-Dome for Thin Watches w/ Step	G-S Stock Number	8.4 - 36.2mm	\$5.00
PKH	Lo-Dome for Thin Watches w/ Step - Larger Sizes	G-S Stock Number	36.5 - 57.1mm	\$6.95
PT	Prism-Tite 9 Facet Fashion Watch w/ White & Yellow Rings	mm size	15.0 - 31.0	\$10.25
ST	Step-Tite Waterproof w/ White & Yellow Rings	mm size	15.0 - 34.5	\$9.75
TR	Thin-Ringless Very thin watches	mm size	15.0 - 36.0	\$7.50
TT	Thin-Tite Very thin w/White & Yellow Rings	mm size	15.0 - 36.0	\$9.75
VT	Veri-Thin Ultra-thin watches	G-S Stock Number	14.6 - 33.0	\$6.25
W	Micon Flat for Gauges	G-S Stock Number	17.7 - 76.2	\$9.00
WT	Wide-Tite W/extra Wide White or Yellow Rings	mm size & color	29.5 - 31.9	\$8.75
XHD	Extra Hi-Dome for crowned dials w/step	G-S Stock Number	24.1 - 35.2	\$8.75

G-S ROUND CRYSTAL SIZES AND CORRESPONDING MILLIMETER SIZES

G-S Round Crystal numbering system for HC, KT, PHD, PK, PKH, W, XHD is unique and originated by G-S

G-S	mm	G-S	mm	G-S	mm	G-S	mm	G-S	mm	G-S	mm	G-S	mm	G-S	mm
12.2	12.2	5	15.8	10 1/2	19.3	16	22.8	21 1/2	26.3	29	31.1	40	38.1	51	45.0
12.5	12.5	5 1/4	16.0	10 3/4	19.5	16 1/4	22.9	21 3/4	26.4	29 1/2	31.4	40 1/2	38.4	51 1/4	45.4
12.7	12.7	5 1/2	16.2	11	19.7	16 1/2	23.1	22	26.6	30	31.7	41	38.7	52	45.7
1/4	12.8	5 3/4	16.3	11 1/4	19.8	16 3/4	23.3	22 1/4	26.7	30 1/2	32.0	41 1/2	39.0	52 1/2	46.0
3/4	13.0	6	16.5	11 1/2	20.0	17	23.5	22 1/2	26.9	31	32.3	42	39.3	53	46.3
1	13.1	6 1/4	16.6	11 3/4	20.1	17 1/4	23.6	22 3/4	27.1	31 1/2	32.7	42 1/2	39.6	53 1/2	46.6
1 1/4	13.2	6 1/2	16.8	12	20.3	17 1/2	23.8	23	27.3	32	33.0	43	40.0	54	47.0
1 1/2	13.5	6 3/4	16.9	12 1/4	20.4	17 3/4	23.9	23 1/2	27.4	32 1/2	33.3	43 1/2	40.3	54 1/2	47.3
1 3/4	13.6	7	17.1	12 1/2	20.6	18	24.1	23 3/4	27.6	33	33.6	44	40.6	55	47.6
2	13.8	7 1/4	17.2	12 3/4	20.7	18 1/4	24.2	23 3/4	27.7	33 1/2	33.9	44 1/2	40.9	55 1/2	47.9
2 1/4	14.0	7 1/2	17.4	13	20.9	18 1/2	24.4	24	27.9	34	34.3	45	41.2	56	48.2
2 1/2	14.1	7 3/4	17.5	13 1/4	21.0	18 3/4	24.5	24 1/4	28.1	34 1/2	34.6	45 1/2	41.6	56 1/2	48.5
2 3/4	14.2	8	17.7	13 1/2	21.2	19	24.7	24 1/2	28.2	35	34.9	46	41.9	57	48.9
3	14.4	8 1/4	17.9	13 3/4	21.4	19 1/4	24.8	24 3/4	28.3	35 1/2	35.2	46 1/2	42.2	57 1/2	49.2
3 1/4	14.6	8 1/2	18.1	14	21.6	19 1/2	25.0	25	28.5	36	35.5	47	42.5	58	49.5
3 1/2	14.7	8 3/4	18.2	14 1/4	21.7	19 3/4	25.2	25 1/2	28.9	36 1/2	35.8	47 1/2	42.8	58 1/2	49.8
3 3/4	14.9	9	18.4	14 1/2	21.9	20	25.4	26	29.2	37	36.2	48	43.1	59	50.1
4	15.2	9 1/4	18.6	14 3/4	22.0	20 1/4	25.5	26 1/2	29.5	37 1/2	36.5	48 1/2	43.5	59 1/2	50.4
4 1/4	15.3	9 1/2	18.7	15	22.2	20 1/2	25.7	27	29.8	38	36.8	49	43.8	60	50.8
4 1/2	15.5	9 3/4	18.9	15 1/4	22.3	20 3/4	25.8	27 1/2	30.1	38 1/2	37.1	49 1/2	44.1	60 1/2	51.1
4 3/4	15.6	10	19.0	15 1/2	22.5	21	26.0	28	30.4	39	37.4	50	44.4	61	51.4
		10 1/4	19.1	15 3/4	22.6	21 1/4	26.1	28 1/2	30.8	39 1/2	37.7	50 1/2	44.7	61 1/2	51.7

Bulk Watch Straps by the Dozen of a Size & Color



Ladies' Genuine Calf Bulk

Stitched & Padded. Sold by dozen of one size, one color.

680.027.10	10mm	Black	\$36.00 dz
680.027.12	12mm	Black	36.00 dz
680.027.13	13mm	Black	36.00 dz
680.027.14	14mm	Black	36.00 dz
680.027.20	10mm	Brown	36.00 dz
680.027.22	12mm	Brown	36.00 dz
680.027.23	13mm	Brown	36.00 dz
680.027.24	14mm	Brown	36.00 dz
680.027.112	12mm	Long Black	40.50 dz
680.027.113	13mm	Long Black	40.50 dz
680.027.114	14mm	Long Black	40.50 dz
680.027.212	12mm	Long Brown	40.50 dz
680.027.213	13mm	Long Brown	40.50 dz
680.027.214	14mm	Long Brown	40.50 dz



Ladies' LIZARD GRAIN Calf Bulk

Regular lengths sold by dozen of one size, one color.

680.041.10	10mm	Black	12.00 dz
680.041.11	11mm	Black	12.00 dz
680.041.28	8mm	Brown	12.00 dz
680.041.20	10mm	Brown	12.00 dz
680.041.21	11mm	Brown	12.00 dz
680.041.23	13mm	Brown	12.00 dz
680.041.24	14mm	Brown	12.00 dz



Ladies' ALLIGATOR GRAIN Calf Bulk

Regular lengths sold by dozen of one size, one color.

680.040.10	10mm	Black	12.00 dz
680.040.28	8mm	Brown	12.00 dz
680.040.20	10mm	Brown	12.00 dz
680.040.21	11mm	Brown	12.00 dz
680.040.24	14mm	Brown	12.00 dz



Men's Genuine Calf Bulk

Regular and Long sizes sold by dozen of one size, one color (XXLong sold by the piece).

680.014.16	16mm	Black	\$36.00 dz
680.014.18	18mm	Black	36.00 dz
680.014.19	19mm	Black	36.00 dz
680.014.20	20mm	Black	36.00 dz
680.014.26	16mm	Brown	36.00 dz
680.014.28	18mm	Brown	36.00 dz
680.014.29	19mm	Brown	36.00 dz
680.014.30	20mm	Brown	36.00 dz
680.014.116	16mm	Long Black	40.50 dz
680.014.118	18mm	Long Black	40.50 dz
680.014.119	19mm	Long Black	40.50 dz
680.014.120	20mm	Long Black	40.50 dz
680.014.216	16mm	Long Brown	40.50 dz
680.014.218	18mm	Long Brown	40.50 dz
680.014.219	19mm	Long Brown	40.50 dz
680.014.220	20mm	Long Brown	40.50 dz
680.014.11	18mm	XXLong 9 1/2" Black	5.50 ea
680.014.12	18mm	XXLong 9 1/2" Brown	5.50 ea



Men's Lizard Grain Calf Bulk

Regular Length. Sold by dozen.

680.015.29	19mm	Brown	\$12.00 dz
-------------------	------	-------	-------------------



Ladies' Swiss Army Style Black Woven Strap

Leather with yellow buckle. Available 12 and 13mm. Bulk.

680.080.12	12mm	Black	\$2.25 ea
680.080.13	13mm	Black	2.25 ea



Men's Lizard Grain Calf, Stitchless - One Dozen in Folder

One dozen stitchless straps. Assortment contains 2 each black and brown, 16, 18 and 19mm.

680.005 Regular Length Assortment **\$42.00**



Ladies' Padded Calf - One Dozen in Folder

Stitched and padded assorted black and brown. Assorted popular end sizes.

680.020 Regular Length Assortment **\$38.95 dz**

680.022 Long Length Assortment **42.00 dz**



Men's Padded Calf - One Dozen in Folder

One dozen men's stitched padded calf. Assortments contain 2 each black and brown, 16, 18 and 19mm.

680.006 Regular Length Assortment **\$38.95**

680.060 Long Length Assortment **42.00**



Men's One-Piece Genuine Leather Straps

Regular WBHQ #409 & Long #409L. Cards of 6 or individual men's stitched and padded in black and brown.

680.025 Asst. Regular Lngth Black & Brown **\$51.00/6**

680.025.2 Regular Black **9.00 ea**

680.025.3 Regular Brown **9.00 ea**



Men's Extra Wide 24mm Padded Calf Straps

Genuine leather available black and brown. Bulk.

680.077 24mm Black **\$8.00**

680.078 24mm Brown **8.00**



Ladies' Genuine Crocodile Straps - Individual

Regular Length. Bulk.

680.090.13 13mm Black **\$31.50 ea**

680.090.23 13mm Brown **31.50 ea**

680.090.33 13mm Burgundy **31.50 ea**

Extra Wide Crocodile Grain Straps

Available in wide widths in black, white, or blue.

680.084.30 30mm Black **\$5.25 ea**

680.083.26 26mm White **\$5.25 ea**

680.082.26 26mm Blue **\$5.25 ea**

Catalog prices are jewelers' costs, not retail.

WATCH STRAPS - LEATHER



Men's Extra Wide Straps

Double stitched genuine leather straps are 1 $\frac{3}{8}$ " wide with 18mm snap-on lug tabs. 9 $\frac{3}{8}$ " long. Black or brown.

680.076.1	Black	WBHQ #01	\$10.50
680.076.2	Brown	WBHQ #02	10.50



Black Leather One-Piece

F601-0108	8mm	\$11.50
F601-0112	12.5mm	\$11.50
F601-0114	14mm	\$11.50
F601-0118	18mm	\$11.50

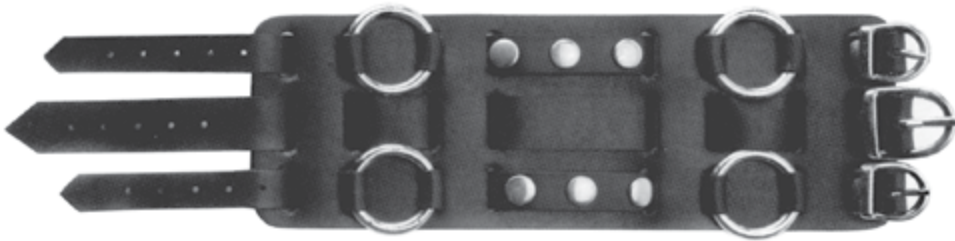

Leather Strap Keepers

Assortment of 20 pieces (5 each of sizes 10, 12, 18 and 20mm) in black or brown.

680.051	Black Assortment	\$9.95
680.052	Brown Assortment	\$9.95

Men's Mod Wide Leather Strap

2 $\frac{1}{2}$ " wide, black.

680.087	Black	WBHQ #03	\$12.75
----------------	-------	----------	----------------



Textured Calf

F66-0106	6mm	Black	\$10.50
-----------------	-----	-------	----------------



Swiss Army Style

FY90-0116	16mm	Black	\$10.00
------------------	------	-------	----------------



Lizard Calf - White

F40L-0918	18mm	White	\$9.50
------------------	------	-------	---------------



Stitched Calf

VFS60-0213	13mm	Brown	\$5.25
-------------------	------	-------	---------------



Lizard Calf - Pink

F40-1112	12mm	Pink	\$9.00
-----------------	------	------	---------------



Nubba Calf

VLS68-0213	13mm	Brown	\$5.25
-------------------	------	-------	---------------



Lizard Calf - Red

F40-0512	12mm	Red	\$9.00
-----------------	------	-----	---------------



Chrono Sport

VMS67-0213	13mm	Brown	\$6.25
-------------------	------	-------	---------------



Calfskin Smooth - Black

F60-0112	12mm	Black	\$9.00
-----------------	------	-------	---------------

Quality watch bands
in hard-to-find sizes and styles.



Gents Expansion
552-BL 17-22mm 7¹/₄" long Black **\$8.50**



Gents Expansion
532-YL 17-22mm 7¹/₄" long Yellow **\$12.50**



Gents Expansion
534-YL 17-22mm 7³/₈" long Yellow **\$12.50**



Gents Expansion
534-SL 17-22mm 7¹/₄" long White **\$8.50**



Gents Expansion
534-TL 17-22mm 7³/₈" long Two-Tone **\$12.50**



Ladies Bracelet
1010-Y 10-13mm 6³/₈" long Yellow **\$12.50**

Catalog prices are jewelers' costs, not retail.



Metal Stretch Bands

Assortments of 12 ladies or mens in yellow and white. Bands are assorted styles, one adjustable end size each; Ladies' have 9-12mm ends, Men's have 16-21mm ends.

680.033	Ladies Yellow & White	\$55.50 dz
680.033W	Ladies White	54.50 dz
680.044	Ladies Yellow & White Long	55.50 dz
680.034	Mens Straight & Curved Yellow & White	63.00 dz
680.034W	Mens Straight & Curved White	54.50 dz
680.035	Mens Straight & Curved Yellow	72.00 dz



Metal Stretch Half-Bands

Open ends for silver and turquoise type watch attachments. Ladies ends are 1/8" wide, men's are 9/16". White bands available in two lengths. Yellow Speidel bands available men's or ladies'. Prices are Jewelers Costs.

680.065	White	Ladies	2 ³ / ₄ "	\$ 4.25 ea
680.066	White	Ladies	3 ¹ / ₂ "	5.25 ea
680.067	White	Mens	2 ³ / ₄ "	4.25 ea
680.068	White	Mens	3 ¹ / ₂ "	5.25 ea
680.069	Yellow	Ladies	3"	13.50 ea
680.070	Yellow	Mens	3 ¹ / ₈ "	13.50 ea



Ladies' Mesh Bracelet

10mm at case, 6.8mm fork end fits Seiko, Pulsar and many other ladies' watches. Yellow or White.

680.450.1	Yellow	\$10.95
680.450.2	White	5.50

WATCH STRAPS - DIVER

Seiko Style Diver Straps

Fits Seiko & Pro Diver. Black Rubber. Heavy duty PVC strap with stainless steel buckle. 20mm, 22mm, and 26mm.



680.448 Submariner 20mm **\$17.50 ea**



680.650 Diver 22mm **\$3.95 ea**



680.652 Seiko Style 22mm **\$10.95 ea**



680.653 Seiko Style 20mm **\$10.95 ea**



680.655 Diver 26mm **\$5.95 ea**



680.671 Link Style Silicone 16mm **\$5.95 ea**



680.670 Tire Tread Silicone 16mm **\$5.95 ea**



680.001.355 19mm **\$2.25 ea, 12@\$1.95 ea**



680.001.353 20mm **\$2.25 ea, 12@\$1.95 ea**



680.001.357 20mm **\$2.25 ea, 12@\$1.95 ea**



017804 22mm Silicone **\$6.95**

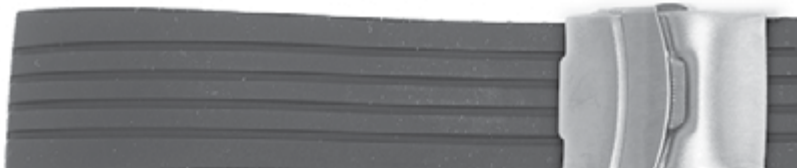

017811 24mm Silicone **\$7.95**



017816 23mm White Silicone **\$7.50**



G-Shock Strap

Fits popular Casio G-Shock. Black.

680.649 18mm Bulk **\$7.95 ea**

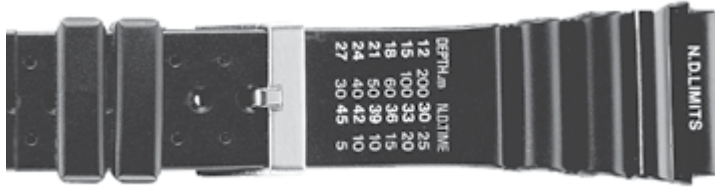

WB-17 Fits Citizen Promaster 24mm **\$6.50**



WB-32 Fits Casio & others 19mm **\$4.50**

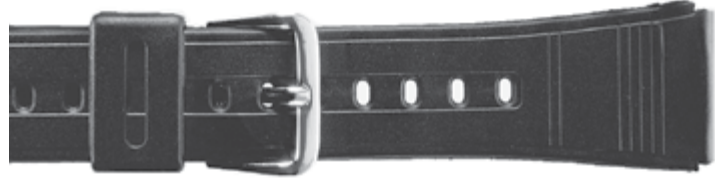

WB-18 Fits Casio Databank 22mm **\$5.00**



WB-33 Fits Casio & others 20mm **\$5.00**



WB-19 Fits Citizen Windsurfer 20mm **\$6.50**

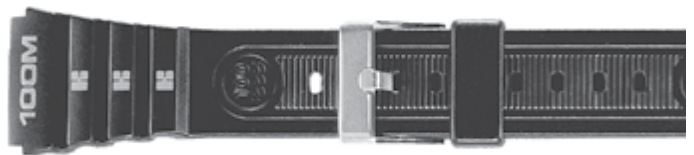

WB-37 Fits Timex Ironman 19mm **\$5.50**



WB-27 Fits Timex Indiglo Ironman 19mm **\$5.00**



WB-38 Fits Casio & others 20mm **\$5.00**



WB-30 Fits Casio G Shock 18mm **\$5.50**

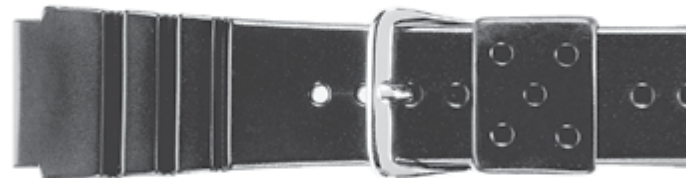

WB-40 Fits Seiko & Pro Diver 22mm **\$6.50**

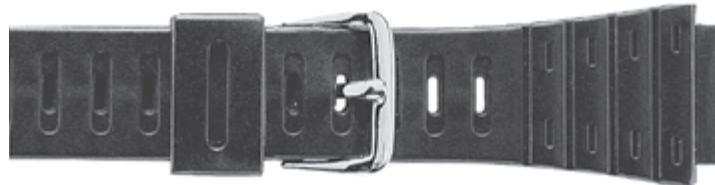

WB-31 Fits Casio G Shock 20mm **\$5.00**



WB-54 Fits Timex Triathlon & others 18mm **\$5.50**



Sport Straps

Black plastic Casio style replacement straps.

WB-70-18 **\$5.95**

WB-70-20 **\$5.95**



WB-57 Fits Casio & others 24mm **\$6.50**

Catalog prices are jewelers' costs, not retail.



Black Stainless Jubilee Style Band

680.449 15-21mm adjustable ends Black \$19.95

Colorful Silicone Bands



Blue Silicone Bands

680.656	18mm	
680.657	20mm	
680.658	22mm	
680.659	24mm	\$5.95 ea



Red Silicone Bands

680.660	18mm	
680.661	20mm	
680.662	22mm	
680.663	24mm	\$5.95 ea



Yellow Silicone Bands

680.664	18mm	
680.665	20mm	
680.666	22mm	
680.667	24mm	\$5.95 ea

Bracelets to fit RLX



680.071 to fit Ladies Jubilee 13mm Jewelers Cost \$21.95



680.072 to fit Men's Jubilee 20mm Jewelers Cost \$21.95



680.073 to fit Ladies Oyster 13mm Jewelers Cost \$21.95



680.075 to fit Men's Oyster w/Extension 20mm Jewelers Cost \$21.95

Cas-Ker Co. is independent of and is not affiliated with or sponsored by Rolex Watch U.S.A. Inc. Rolex warranty does not apply to non-genuine replacement items supplied by Cas-Ker.

**American
Liberty
Watchbands**

MANUFACTURED IN THE U.S.A.



302W White 5³/₄" 9-12mm \$7.50



WBHQ Black Nylon/Velcro Sport Wrap - 19mm
WB-150BK \$6.50



WBHQ Green Nylon/Velcro Sport Wrap - 19mm
WB-150GR \$6.50



WBHQ Navy Nylon/Velcro Sport Wrap - 19mm
WB-150BL \$6.50



WBHQ Black Leather Sport Wrap - 19mm
WB-550BK \$7.50



WBHQ Navy Blue Leather Sport Wrap - 20mm
WB-550BL \$7.50



WBHQ Camo Leather Sport Wrap - 20mm
WB-550CM \$7.50



**Don Juan
Stainless Steel #1 Band**

680.050.1	Small	5/8"	\$16.95
680.050.2	Medium	5/8"	16.95
680.050.3	Large	5/8"	16.95
680.050.4	Small	11/16"	16.95
680.050.5	Medium	11/16"	16.95
680.050.6	Large	11/16"	16.95
680.050.7	Small	3/4"	16.95
680.050.8	Medium	3/4"	16.95
680.050.9	Large	3/4"	16.95

Nylon WB-3640 thru WB-3649 \$7.50 each



WB-3640BK 20mm Nato Black



WB-3640BL 20mm Nato Navy



WB-3640OL 20mm Nato Olive



WB-3640TN 20mm Nato Tan



WB-3641 18mm Nato Orange Stripe



WB-3642 18mm Nato Grey Stripe

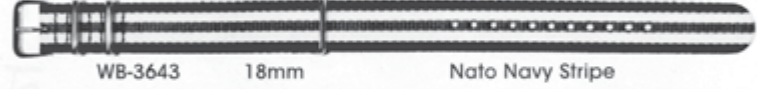

WB-3643 18mm Nato Navy Stripe



WB-3644 20mm Nato Red/Blue Stripe



WB-3645 20mm Nato Red/Blue/Yellow



WB-3646 20mm Nato Red/Blue/White



WB-3647 20mm Nato Red/Black



WB-3648 20mm Nato Green/Red

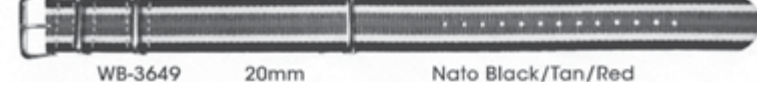

WB-3649 20mm Nato Black/Tan/Red

Leather WB-410 \$12.00 each



WB-410BR 18mm Nato Leather Brown



WB-410BK 18mm Nato Leather Black



Men's Leather Cuff Strap

11/16" end sizes.

680.018	Assortment	\$96.00 dz
680.018.1	Black Strap	9.00 ea
680.018.2	Brown Strap	9.00 ea

NATO MEDICAL ALERT BANDS



Black and Grey Nylon Nato Style Band
Woven band with stainless steel plaque.
Measures 18mm.
DTJ-3642 **\$12.95**



Black and Orange Nylon Nato Style Band
Woven band with stainless steel plaque.
Measures 18mm.
DTJ-3641 **\$12.95**



Blue, Black, and White Band
Woven band with stainless steel plaque.
Measures 18mm.
DTJ-3643 **\$12.95**



Solid Olive Nylon Band
Olive color with stainless steel.
Measures 20mm.
DTJ-3640OL **\$12.95**



Solid Black Nylon Band
Black color with stainless steel.
Measures 20mm.
DTJ-3640BK **\$12.95**



Solid Blue Nylon Band
Blue color with stainless steel.
Measures 20mm.
DTJ-3640BL **\$12.95**



Leather Band
Genuine leather and stainless steel.
Measures 18mm.
DTJ-410BR Brown **\$19.50**
DTJ-410BK Black **\$19.50**



Double Wrap Leather Band
Genuine leather and stainless steel.
Adjusts to fit wrists up to 7.5".
DTJ-41-06 Brown **\$18.00**
DTJ-41-05 Black **\$18.00**



Replacement Plaques
Stainless steel replacement plaque for Medical Alert Bands are available in two sizes:
DTJ-2018 18mm **\$8.00**
DTJ-2020 20mm **\$8.00**



NATO Leather Sport Straps
20mm wide fits wrists 6"-9".
WB-410BK Black Leather **\$12.00ea**
WB-410BR Brown Leather **\$12.00ea**

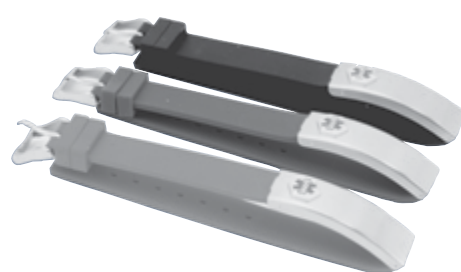

Rubber Medical Straps
Rubber straps with stainless steel buckles fits wrists 6" to 7-3/4".
DTJ-70 Black **\$12.95**
DTJ-71 Red **\$12.95**
DTJ-72 Blue **\$12.95**



Pendant on Chain
38-26-12 Heart **\$12.00**
38-27-12 Round **\$12.00**



Gent's Bracelet

41-48-15 (DTJ-48)	Stainless Steel, 8"	\$32.00
41-49-11 (DTJ-49)	Gold Plate, 8"	\$36.00
41-48B (DTJ-48B)	Black Plate Stainless Steel, 8"	\$36.00



Gent's Medical Ident Bracelet 8"

41-35-12 (DTJ-35)	Stainless Steel	\$17.00
41-36-11 (DTJ-36)	Gold Plate	\$21.00
41-35B (DTJ-35B)	Black Plate Stainless Steel, 8"	\$21.00



Gent's Medical Expansion Bracelet

41-33-12 (DTJ-33)	Stainless Steel	\$17.00
41-32-11 (DTJ-32)	Gold Plate	\$21.00



Dog Tag with Chain

Stainless Steel, 26" Chain	
38-45-12 (DTJ-45)	\$17.00
Ion Gold Plate, 26" Chain	
38-45-11 (DTJ-45G)	\$21.00
Black Plate, 25" Chain	
38-45B (DTJ-45B)	\$21.00



Double I.D. Pendant

Stainless Steel, 25" Chain	
38-34-12 (DTJ-34)	\$16.00
Ion Gold Plate, 25" Chain	
38-34-11 (DTJ-34G)	\$21.00



Medical Charm

40-37-12 (DTJ-37C)	White, 3/8" diameter	\$5.00
40-38-11 (DTJ-38C)	Yellow, 3/8" diameter	\$5.00



Ladies' Medical Ident Bracelet 7"

41-37-12 (DTJ-37)	Stainless	\$17.00
41-38-11 (DTJ-38)	Gold Plate	\$21.00



Child's Bracelet

41-39-12 (DTJ-39)	Stainless Steel, 6"	\$15.00
--------------------------	---------------------	----------------



Ladies' Bracelet

Stainless Steel, 7"	
41-26-12 (DTJ-26)	\$15.00



Ladies' Medical Expansion Bracelet

41-31-12 (DTJ-31)	Stainless Steel	\$17.00
41-30-11 (DTJ-30)	Gold Plate	\$21.00



Ladies' Bangle

41-46-15 (DTJ-46)	Stainless Steel	\$21.00
41-46-11 (DTJ-46G)	Gold Plate	\$28.00

Zipper Pull

Stainless w/ Lobster Claw DTJ-27

40-27-15	\$12.00
-----------------	----------------



Key Chain

Stainless Steel DTJ-28

41-28-15	\$12.00
-----------------	----------------

Catalog prices are jewelers' costs. Call us for a copy of the WBHQ catalog with retail prices.



Energizer Master Battery Replacement Kit

Master Kit includes 189 of the most popular Energizer Watch Batteries:

1	335	Energizer Battery
1	341	Energizer Battery
2	337	Energizer Battery
5	315	Energizer Battery
5	317	Energizer Battery
5	319	Energizer Battery
5	321	Energizer Battery
5	329	Energizer Battery
5	344/350	Energizer Battery
5	387S	Energizer Battery
5	393	Energizer Battery
5	394/380	Energizer Battery
5	1216	Energizer Battery
5	2032	Energizer Battery
10	357/303	Energizer Battery
10	362/361	Energizer Battery
10	364	Energizer Battery
10	379	Energizer Battery
10	386/301	Energizer Battery
10	390	Energizer Battery
10	391/381	Energizer Battery
10	392/384	Energizer Battery
10	397/396	Energizer Battery
10	2016	Energizer Battery
15	377/376	Energizer Battery
15	395/399	Energizer Battery
1	340.346	Battery Tester
1	520.000	Screwdriver Set of 7
1	590.046	Opener for Snap Back Cases
1	590.099	Imitation Jaxa Case Wrench
1	571.958	Plastic Tweezer
1	590.012	Spring Bar Tool
1	590.201	Case Holder with Clamp
1	590.255	Adjustable Pocket Case Wrench
1	810.224	60-Drawer Battery Cabinet
1		Battery Size Checker
1		Battery Replacement Guide

(Tool items subject to substitution)

810.220 Master Battery Kit

[Call For Price](#)

Energizer Economy Battery Kit

Economy Kit includes 160 Batteries and Cabinet only:

5	337	Energizer Battery
5	373	Energizer Battery
5	394/380	Energizer Battery
5	397/396	Energizer Battery
10	317	Energizer Battery
10	321	Energizer Battery
10	344/350	Energizer Battery
10	362/361	Energizer Battery
10	395/399	Energizer Battery
10	1216	Energizer Battery
10	2016	Energizer Battery
10	2032	Energizer Battery
15	364	Energizer Battery
15	371/370	Energizer Battery
15	377/376	Energizer Battery
15	379	Energizer Battery
1	810.224	60-Drawer Battery Cabinet

810.221 Economy Battery Kit

[Call For Price](#)



Cas-Ker Co.
1.800.487.0408



ACCOUNT/I.D.# _____

NAME _____

SHIP VIA _____

PRICING & SHIPPING INFORMATION

Pricing for higher quantities available upon request.

ALL LITHIUM BATTERIES WILL BE SHIPPED UPS GROUND

LITHIUM BATTERIES		PRICES ARE PER BATTERY			
Quantity	No.	Brand	100	20	5
	1025	Energizer	\$.75	\$.76	\$.77
	1216	Energizer	.80	.82	.83
	1220	Energizer	.63	.67	.69
	1225	Energizer	.86	.88	.89
	1612	Panasonic			4.95
	1616	Energizer	.63	.68	.69
	1620	Energizer	.64	.65	.66
	1632	Energizer	.74	.75	.76
	2012	Maxell	1.35	1.40	1.45
	2016	Energizer	.50	.51	.52
	2025	Energizer	.50	.52	.53
	2032	Energizer	.50	.52	.53
	2320	Renata		1.95	2.00
	2325	Renata		1.34	1.44
	2354	Panasonic			5.00
	2412	Panasonic			5.95
	2430	Energizer	1.00	1.02	1.05
	2450	Energizer	1.18	1.53	1.54

Others	1-4	5-29
421SW	\$5.00	\$4.50
SR927W	\$1.50	\$1.05
N	\$3.25/2 pk	\$2.95/2 pk
C & D	\$4.00/2 pk	
9V	\$4.00 each	
AA	\$3.80/4 Pack	
AAA	\$3.80/4 Pack	

ADAPTER FOR
CARTIER ALARM CLOCKS
Use with V625PX Battery
980.999 \$10.00

CASIO BATTERIES	
CTL-920	\$15.00 ea
CTL-1616	\$14.00 ea
ML-2016	\$9.95 ea

ACCUCCELL - Replaces 343 & 387
Accucell-1 \$9.95ea 3@\$8.50

PHOTO - ENERGIZER
A23BP-2 \$5.00/2 Pack
EL123APBP-2 lithium \$9.95/2 Pack

HEARING AID - ENERGIZER
AC10E-8 \$6.95/8 pack
AC13E-8 \$8.50/8 pack
AC312E-8 \$8.50/8 pack
AC675E-4 \$4.25/4 pack

ENERGIZER WATCH BATTERIES

- PRICES ARE PER BATTERY, ONE NUMBER.
- MINIMUM LINE INVOICED \$1.50
- 120 ASSORTED/30 PIECE PRICE SOLD IN STRIPS OF FIVE.

Quantity	No.	100	30 or 120 Assorted	5
	201 Use adapter 916.500 w/394			
	301 Use 386/301			
	303 Use 357/303			
	315	\$.77	\$.78	\$.80
	317	.68	.70	.71
	319	.67	.68	.70
	321	.54	.55	.56
	329	.86	.87	.88
	335	1.22	1.27	1.29
	337	1.79	1.83	1.89
	341	1.62	1.65	1.66
	344/350	1.76	1.81	1.83
	346	1.60	1.64	1.65
	350 Use 344/350			
	355 Use adapter 916.002 w/357			
	357/303	1.38	1.40	1.45
	362/361	.50	.51	.53
	364	.33	.34	.35
	364SP	.32	.33	.35
	365/366	1.28	1.30	1.31
	366 Use 365/366			
	370 Use 371/370			
	371/370	.54	.55	.56
	371SP	.50	.52	.55
	373	.78	.80	.81
	377/376	.36	.37	.38
	377SP	.33	.34	.35
	379	.45	.47	.48
	380 Use 394/380			
	381 Use Maxell 391/381			
	384 Use 392/384			
	386/301	1.36	1.46	1.47
	387S	1.84	1.87	1.88
	388 Use adapter 916.388 w/329			
	389 Use 390/389			
	390/389	.77	.80	.82
	391/381 Maxell	.91	.92	.98
	392/384	.59	.60	.61
	393	1.22	1.26	1.28
	394/380	.92	.93	.94
	395/399	.61	.63	.65
	396 Use 397/396			
	397/396	.61	.64	.65
	399 Use 395/399			

Battery Adapters \$6.00ea
 916.002 use 357 to replace 355 in Pulsar LED
 916.500 use 394 to replace 201 in Hamilton 500 & 505
 916.388 use 329 to replace 388

WATCH BATTERY CROSS REFERENCE

Energizer	AWI	Bulova	Duracell	Maxell	Panasonic	Ray-O-Vac	Renata	Sanyo	Sony	Toshiba	Seiko	Varta	Other
301 (386)	S04	226	D301	SR43SW	SP301	301	301	-	-	SR43SW	SR43SW	V301	GS12, D
303 (357)	S06	-	D303	SR44SW	SP303	303	303	-	-	SR44SW	SR44SW	V303	S200,A, GS14
315	S38	614	D315	SR716SW	SP315	315	315	-	-	SR716SW	SR716SW	V315	-
317	S52	616	D317	SR516SW	SP317	317	317	-	-	SR516SW	SR516SW	V317	CA
319	S54	615	D319	SR527SW	SP319	319	319	-	-	SR527SW	SR/TR527SW	V319	-
321	S34	611	D321	SR616SW	SP321	321	321	-	-	SR616SW	SR/TR616SW	V321	S616/DPV, DA
329	S42	-	D329	SR731SW	-	329	329	-	-	-	SR731SW	V329	-
335	S60	622	-	SR512SW	SP335	-	335	-	-	-	SR512SW	-	-
337	S70	-	-	SR416SW	-	-	337	-	SR416SW	-	-	-	-
341	S36	-	-	-	-	RW322	341	-	-	-	-	V341	-
344/350	S10	242	D344	SR1136SW	WS12	344	344	-	-	-	-	V344	-
346	S64	-	-	SR712SW	SP346	-	346	-	-	-	SR/TR712SW	-	-
350 (344)	S01	-	D350	-	-	-	350	-	-	-	-	V350	-
357/303	S05	228	D357	SR44W	SP357	357	357	-	-	SR44W	SR44W	V357	EPX76/S76, J, GS13/GP57, 57
361 (362)	S23	-	D361	SR721W	SP361	361	361	-	-	SR721W	SR/TR721W	V361	X
362/361	S12	601	D362	SR721SW	SP362	362	362	-	-	SR721SW	SR/TR721SW	V362	GP62, S
364	S14	602	D364	SR621SW	SP364	364	364	-	-	SR621SW	SR/TR621SW	V364	GP64/SG1,T
365/366	S35	-	-	SR1116W	-	-	365	-	-	SR1116W	SR/TR1116W	-	-
366 (365)	S16	608	D366	SR1116SW	-	366	366	-	-	SR1116SW	SR1116SW	V366	-
370 (371)	S21	620	D370	SR920W	SP370	370	370	-	-	SR920W	SR920W	V370	Z
371/370	S18	605	D371	SR920SW	SP371	371	371	-	-	SR920SW	SR/TR920SW	V371	GP71
373	S40	617	D373	SR916SW	SP373	373	373	-	-	SR916SW	SR/TR916SW	V373	HA
376 (377)	S27	619	-	SR626W	SP376	-	376	-	-	SR626W	SR/TR626W	-	-
377/376	S32	606	D377	SR626SW	SP377	377	377	-	-	SR626SW	SR626SW	V377	BA
379	S56	618	D379	SR521SW	SP379	379	-	-	-	SR521SW	SR/TR521SW	V379	-
380 (394)							380						
381 (Max)	S20	317	D381	SR1120SW	-	381	381	-	-	SR1120SW	SR/	V381	-
384 (392)	S22	247	D384	SR41SW	SP384	384	384	-	-	SR41SW	SR/TR41SW	V384	S314/GS3, GP84/SG3
386/301	S07	260	D386	SR43W	SP386	386	386	-	-	SR43W	SR43W	V386	GP86, H, 86, S150/SG12
387S	-	-	-	-	-	-	-	-	-	-	-	-	-
389 (390)	S09	-	D389	SR1130W	SP389	389	389	-	-	SR1130W	SR1130W	V389	289/8019, M, 89, GP89/S120/SG10
390/389	S24	603	D390	SR1130SW	WS-10	390	390	-	-	SR1130SW	TR1130SW	V390	-
391 Disc.	S11	609	D391	SR1120W	SP391	391	391	-	-	SR1120W	SR/TR1120W	V391	291/S080, 317, 91, GP91/SG8, L
392/384	S13	247	D392	SR41W	SP392	392	392	-	-	SR41W	SR/TR41W	V392	GP92/G3, K, SG3/192, 92
393	S15	255	D393	SR754W	SP393	393	393	-	-	SR48W	SR48W	V393	S320/GP93, F, 93, 193/G5/SG5
394/380	S26	-	D394	SR936SW	-	394	394	-	-	SR936SW	SR936SW	V394	GP94, 94
395/399	S28	610	D395	SR927SW	SP395	395	395	-	-	SR927SW	SRT/TR927SW	V395	GP95, 95
396 (397)	S17	612	D396	SR726W	SP396	396	396	-	-	SR726W	SR/TR726W	V396	GP96/SG2, V
397/396	S30	607	D397	SR726SW	SP397	397	397	-	-	SR726SW	SR/TR726SW	V397	SG2/8033, N, 97
399 (395)	S19	613	D399	SR927W	SP399	399	399	-	-	SR927W	SR/TR927W	V399	8034/GP99, W

Copyright Energizer Battery, Co.

MEASUREMENTS		
B&S	INCHES	MM
1	.28930	7.348
2	.25763	6.543
3	.22942	5.827
4	.20431	5.189
5	.18194	4.621
6	.16202	4.115
7	.14428	3.665
8	.12489	3.264
9	.11443	2.906
10	.10189	2.588
11	.09074	2.305
12	.08080	2.052
13	.07196	1.828
14	.06408	1.628
15	.05706	1.449
16	.05082	1.291
17	.04525	1.149
18	.04030	1.024
19	.03589	0.912
20	.03196	0.812
21	.02846	0.723
22	.02534	0.644
23	.02257	0.573
24	.02010	0.511
25	.01790	0.455
26	.01594	0.405
27	.01419	0.360
28	.01264	0.321
29	.01125	0.286
30	.01002	0.255
31	.00892	0.226
32	.00795	0.202
33	.00708	0.180
34	.00630	0.160
35	.00561	0.142
36	.00500	0.127
37	.00445	0.113
38	.00396	0.100
39	.00353	0.090
40	.00314	0.080

DRILL SIZES			
MM DRILL	MM DRILL	MM DRILL	MM DRILL
0.343	80	2.489	40
0.369	79	2.528	39
0.406	78	2.578	38
0.457	77	2.642	37
0.508	76	2.705	36
0.533	75	2.794	35
0.572	74	2.819	34
0.610	73	2.870	33
0.635	72	2.946	32
0.660	71	3.048	31
0.712	70	3.264	30
0.743	69	3.454	29
0.787	68	3.573	28
0.813	67	3.662	27
0.838	66	3.758	26
0.889	65	3.802	25
0.914	64	3.861	24
0.940	63	3.912	23
0.965	62	3.988	22
0.990	61	4.039	21
1.016	60	4.085	20
1.041	59	4.212	19
1.067	58	4.302	18
1.092	57	4.396	17
1.181	56	4.498	16
1.321	55	4.570	15
1.397	54	4.621	14
1.512	53	4.697	13
1.613	52	4.799	12
1.702	51	4.855	11
1.778	50	4.919	10
1.854	49	4.982	9
1.930	48	5.059	8
1.994	47	5.105	7
2.057	46	5.182	6
2.083	45	5.220	5
2.184	44	5.309	4
2.261	43	5.406	3
2.378	42	5.615	2
2.438	41	5.793	1

PENNYWEIGHT TO OUNCES TO GRAMS		
DWT	OUNCE	GRAM
10	0.5	15.550
20	1	31.104
30	1.5	46.655
40	2	62.207
50	2.5	77.759
60	3	93.311
70	3.5	108.862
80	4	124.414
90	4.5	139.966
100	5	155.518
110	5.5	171.069
120	6	186.621
130	6.5	202.173
140	7	217.725
150	7.5	233.276
160	8	248.828
170	8.5	264.380
180	9	279.932
190	9.5	295.483
200	10	311.035
210	10.5	326.587
220	11	342.139
230	11.5	357.690
240	12	373.242
250	12.5	388.794
260	13	404.346
270	13.5	419.897
280	14	435.449
290	14.5	451.001
300	15	466.553
310	15.5	482.104
320	16	497.656
330	16.5	513.208
340	17	528.760
350	17.5	544.311
360	18	559.863
370	18.5	575.415
380	19	590.967
390	19.5	606.518
400	20	622.070
410	20.5	637.623
420	21	653.174
430	21.5	668.725
440	22	684.277
450	22.5	699.829
460	23	715.381
470	23.5	730.932
480	24	746.484
490	24.5	762.036
500	25	777.588
510	25.5	793.139
520	26	808.691
530	26.5	824.243
540	27	839.795
550	27.5	855.346
560	28	870.898
570	28.5	886.450
580	29	902.002
590	29.5	917.553
600	30	933.105
610	30.5	948.657
620	31	964.209
630	31.5	979.760
640	32	995.312
650	32.5	1010.864
660	33	1026.300

SOLDER MELTING POINTS F°			
GOLD SOLDER			
KARAT	COLOR	HARDNESS	MELTING POINT
10k	Yellow	Easy	1305
10k	Yellow	Easy	1375
10k	Yellow	Medium	1400
10k	Yellow	Hard	1475
10k	White	Easy	1390
10k	White	Medium	1435
10k	White	Hard	1570
10k	Pink	Hard	1550
12k	White	Medium	1425
14k	Yellow	Extra Easy	1295
14k	Yellow	Easy	1340
14k	Yellow	Medium	1390
14k	Yellow	Hard	1480
14k	White	Easy	1390
14k	White	Medium	1450
14k	White	Hard	1570
14k	Pink	Hard	1560
18k	Yellow	Easy	1430
18k	Yellow	Medium	1475
18k	Yellow	Hard	1610
18k	White	Easy	1460
18k	White	Hard	1610
18k	Pink	Hard	1600
19k	White	Hard	1685

PLATINUM SOLDER		MELTING POINT
HARDNESS		
Easy		1300

SILVER SOLDER		MELTING POINT
HARDNESS		
Easy		1325
Medium		1390
Hard		1475
Extra hard		1540

To Convert Grams to DWT:
Divide Grams by 1.555 to get DWT's.

To Convert DWT's to Grams:
Multiply DWT's by 1.555 to get Grams.

- Other Useful Conversions**
- 1 Troy Ounce = 20 DWT
 - 1 Troy Ounce = 31.103 Grams
 - 1 DWT = 1.555 Grams
 - 1 DWT = 7.776 Carats
 - 1 Gram = 5.0 Carats
 - 1 Pound Avoirdupois = 14.583 Troy Ounces

Square Inches from MM sizes:
18mm x 75mm - Multiply 18 x 75, Divide by 625 =
2.16 Square Inches

SAW BLADE SIZES					
Blade Size	Thick	Depth	Teeth per Inch	B&S Gauge	Drill Size
8/0	.0063"	.0126"	89.0	up to 26	80
7/0	.0067"	.0130"	84.0	24 - 26	80
6/0	.0070"	.0140"	76.0	24	79
5/0	.0080"	.0157"	71.0	22 - 24	78
4/0	.0086"	.0175"	66.0	22	77
3/0	.0095"	.0190"	61.0	22	76
2/0	.0103"	.0204"	56.0	20 - 22	75
1/0	.0110"	.0220"	53.5	18 - 22	73
1	.0120"	.0240"	51.0	18 - 20	71
2	.0134"	.0276"	43.0	16 - 18	70
3	.0140"	.0290"	40.5	16 - 18	68
4	.0150"	.0307"	38.0	16 - 18	67
5	.0158"	.0331"	35.5	16	65
6	.0173"	.0370"	33.0	14	58
7	.0189"	.0400"	30.5	12	57
8	.0197"	.0440"	28.0	12	55

NUMERICAL SKU INDEX

14-111	369	111.01310	46		161.339	59	180.368-449	139	221.0501	299	230.825-850	11	
15-111	369			140.001-016	268	161.340-350	62	180.468-569	138	221.0505-0507	292	230.900	10
16-120	281	120.001-007	263	140.030-053	269	161.371-420	58	180.571-590	136	221.0510	299	230.904-905	4
16-121-1-2	303	120.002	94	140.201-202	272	161.425-475	59	180.600-609	138	221.580-630	292	230.908-931	3
16-121-122	281	120.007	95	140.205	271	161.0562	61	180.646-680	136	221.645	296		
38-26-27	434	120.024	197	140.287	272	161.601-755	57	180.799	135	221.755-757	300	231.032	18
38-34-45	435	120.170	266	140.00403-00405	268	161.805-944	56	180.53502-53509	138	221.760-773	299	231.155-163	254
39-20-27	363	120.205	95, 263	140.500	270					221.780-784	300	231.225-228	333
40-27-41-49	435	120.212	265	140.790	271	170.000	42	181.058-064	133	221.791-793	298	231.300-303	20
41-6008-11-12	368	120.222-224	264	140.795	275	170.075	34	181.080	143	221.793-795	300	231.400-402	35
51-120-121	369	120.226	73, 94, 263	140.03502-04002	269	170.076-082	23	181.150-158	135	221.798	298	231.0500	254
51-125-130-7-8	196	120.228-233	264			170.089	21			221.815-816	300	231.0530	20
52-104-11-12	196	120.300-301	125	141.031	269	170.090	23	190.201-202	144	221.820	291	231.640	3
53-105-7-8	196	120.302	265	141.060-067	270	170.091	21	190.311-414	140	221.854	292	231.673	7
53-134	369	120.0310-0314	263	141.070-072	269	170.093	24	190.421-730	142	221.870-872	299	231.719G9	11
57-112-322	368	120.312-315	125	141.120-144	270	170.096	21	190.745-774	140	221.877	292	231.726G	12
1010-Y	429	120.330-331	266	141.164	271	170.101	333	190.800	144	221.890-902	298	231.01850-01910	23
017804-017816	430	120.602-603	264	141.178	270	170.102-103	24	190.802-818	142	221.930	299	231.01856-01910	18
		120.605	261	141.186-191	271	170.104	333	190.889	302	221.949-957	296		
100.735-736	41	120.900	125	141.195-199	270	170.105-106	24	190.925	144	221.11901	291	240.580	124
100.742-744	20			141.200-206	271	170.107	333					240.623	123
100.747-763	49	121.208	267	141.212-294	272	170.317	34	191.928 248, 147, 304		230.003-004	22		
		121.214	264	141.312-330	274	170.500-502	333			230.007	333	241.581	124
101.022	41	121.215-221	265	141.0730	271	170.504-620	24	201.205-251	143	230.009	14	241.990	7
101.120-174	38	121.225-231	267	141.0780-0781	270	170.699	23	201.290-293	141	230.012	22		
101.281-294	41	121.227	96	141.07201-07205	269	170.837	332	201.01401-01406	141	230.014	23	250.000	212
101.311	49	121.305-319	125			170.843-844	49			230.015-017	17	250.075	126
101.406-445	45	121.0451	265	150.001	339	170.845	48	210.101-102	301	230.021-023	16		
101.450-463	44			150.004	336	170.847	332	210.260-270	290	230.024-025	17	251.135	126
101.472-497	45	130.017	313	150.005	334	170.849	49	210.358-382	294	230.029	16		
101.537-542	46	130.025-026	48	150.006	255	170.960	50	210.402	301	230.032	18	260.000-102	65
101.550-610	44	130.048-059	311	150.007	334			210.461	293	230.038	17	260.104	197
101.650-701	37	130.102	313	150.008	339	171.075	24	210.720-726	291	230.040	13	260.200	68
101.712-740	47	130.115	314	150.009	255	171.094-100	42	210.790	292	230.045	4	260.377	130
101.749-882	40	130.118	313	150.010	194, 361	171.115-314	53			230.052-056	5	260.419-500	128
101.01075-01128	47	130.125	314	150.013-015	255	171.135-141	50	211.100	301	230.062-070	15	260.704-705	68
101.3501-3537	38	130.133-154	313	150.050	335	171.200-208	52	211.110-152	302	230.073-074	18		
101.3572-3573	332	130.157	228	150.055	336	171.220-267	54	211.250-254	301	230.076-077	15	261.100-103	197
101.9812-9872	39	130.300-301	250	150.115-116	337	171.0270-0271	23	211.290-390	294	230.079-082	18	261.100-160	267
101.82702-82704	40	130.302	311	150.118	334	171.271-282	54	211.0400-0413	294	230.091-140	3	261.370-388	131
		130.303-325	250	150.130-146	335	171.291-343	55	211.450-511	295	230.150	73, 262	261.385-391	130
110.000	36	130.338	228	150.153	336	171.345-381	54	211.515	296	230.162	254	261.0415A	68
110.001	38	130.340	248, 250	150.154-155	335	171.410-470	55	211.517-518	295	230.164-167	261	261.501	128
110.040-043	36	130.360	338	150.270	336	171.478-484	54	211.530-532	296	230.168	254	261.540-802	130
110.090-096	143	130.361	208, 250	150.271-274	337	171.490-500	55	211.0615	295	230.170-171	4		
110.100	42	130.363-374	338	150.478	336	171.524-531	50	211.662-711	297	230.180-185	5	280.000	147
110.135	39	130.371	73	150.510-540	134	171.541-563	51	211.731	291	230.206-0253	16	280.001	146
110.140-143	36	130.378	170	150.590	334	171.564-589	50	211.740	296	230.218-222	333	280.025	304
110.144-145	136	130.388	323	150.610-611	335	171.610	53	211.760-764	299	230.233	262	280.195	305
110.148	36	130.389	170			171.615-619	52	211.772-773	291	230.250	332	280.211	152
110.160-178	43	130.390	230	151.102	224	171.621-646	51	211.776-799	297	230.255	336	280.214	153
110.180	36	130.391	250	151.108-127	334	171.700-703	53	211.0806-0825	302	230.305	20	280.214-217	147
110.190-193	42	130.393	266	151.301-526	134	171.704-709	52	211.829-890	297	230.330	7	280.455-456	146
110.214-228	43	130.399	170	151.600-614	337	171.716-784	51	211.905	298	230.336	20	280.457	144
110.290-293	45	130.401-403	230			171.831-834	53	211.02890	302	230.405	3	280.460	104, 147
110.333	43	130.500	2	160.000	60	171.841	50	211.05600	143, 296	230.411-430	7	280.501-502	144
110.353-356	45	130.701	39	160.062	62	171.852-853	53	211.70201-70401	297	230.500	14	280.505	147
110.400-500	19	130.800-900	73	160.114	61	171.870-899	49	211.74010-74011	296	230.555	73	280.507	145
110.656-869	36	130.900-901	263	160.118-121	58	171.910-913	53			230.599	8	280.583-596	138, 146
110.975	46	130.900-906	94	160.155	61	171.956-975	48	220.000	300	230.601	9		
110.980	29	130.905-906	264	160.293-312	62	171.01220-01222	154	220.100	291	230.602	12	281.212	152
		130.910-921	289	160.341-342	59	171.01220-53102	50	220.127-360	290	230.603-608	8	281.230-234	147
				160.400	58			220.510-594	293	230.609	12	281.350-500	145
111.126-137	141			160.600-609	56	180.000	144	220.598	292	230.610-618	8, 14	281.503-504	146
111.200-213	38, 43	131.073-110	311	160.625-626	62	180.001-032	137	220.640-644	293	230.620	9	281.530-580	145
111.269-303	41	131.116-128	314			180.033	136	220.655-668	284	230.625	6		
111.310-331	43	131.166	324	161.051	61	180.035	143	220.655-680	17	230.630	21	290.013	323
111.340-351	42	131.0183	338	161.060	62	180.039-061	133	220.753	298	230.631-633	9	290.020-032	318
111.426-440	46	131.199-200	125	161.076	61	180.069	199	220.903	333	230.650-667	6	290.035	323
111.450-465	37	131.0202	208, 250	161.080-081	62	180.153-170	135	220.58301-58401	293	230.700-796	12	290.041-046	317
111.570-580	42	131.327-362	250	161.086-113	61	180.172-317	137			230.797	10	290.062	332
111.716-764	44	131.376	312	161.200-273	60	180.237-282	139	221.119	291	230.805	5	290.075-133	315
111.0776	41	131.377-382	170	161.305-334	62	180.290-358	137	221.450-471	300	230.810	7	290.163-166	320
111.776-902	46	131.450	178										

NUMERICAL INDEX

290.182	319	302	432	350.172-173	204		420.366	256	460.000	197	461.0062	161	
290.195	330	310.000-003	241	350.178-184	214	380.000	193	420.475	259	460.003-012	166	461.080-085	155
290.200-201	319	310.004	240	350.187	215	380.002	194	420.512	257	460.007	160	461.102-110	164
290.202	330	310.384-385	235	350.188	214	380.006	197	420.600	254	460.010-011	155	461.118	157
290.221	329	310.690	242, 236	350.0189	205	380.030-035	196	420.601-603	20	460.018-019	165	461.120-132	164
290.224	330			350.250-252	204	380.040	194	420.905	258	460.027-028	161, 168	461.174	156
290.225-230	329	311.021-038	233	350.254	205	380.042	169	420.6885	254	460.030	157	461.200-211	158
290.232-239	330	311.040-045	232	350.261	206	380.050-060	198	420.8941	255	460.031	161, 168	461.0222	166
290.242-263	316	311.047-054 -063	233	350.262	204	380.090-091	195	420.9101	258	460.033-034	159	461.328	161
290.268	319	311.065-074 -159	232	350.264-265	205	380.095	197	420.9102-9504	257	460.041-046	162	461.346-348	165
290.300-301	325	311.174-187	233	350.268-269	193	380.099	198			460.052-062	157	461.506-532	167
290.307	322	311.200-343	234	350.270	206	380.108	197	421.0212	257	460.063	246	461.02405	132
290.308	191	311.345-399	235	350.271	203	380.110-118	196	421.0213	260	460.066-068	157		
290.308-309	321	311.450-546	237	350.277	213	380.121	191	421.0217-0233	258	460.094-097	163	470.000	31
290.315	323	311.547-650	238	350.284-286	207	380.125	379	421.245	253	460.103	115, 160	470.001	95
290.360-362	322	311.668	237	350.288	206	380.129-160	195	421.260-262	253	460.107	127	470.005	277
290.367	331	311.700-704	239	350.289-291	207	380.180-186	196	421.302-320	256	460.109	168	470.035	27
290.372-374	325	311.01710-01720	241	350.408	74, 212	380.210	192	421.0325-0340	260	460.111	163	470.061	26
290.375	331			350.470	211	380.313-314	198	421.404-470	256	460.113	168	470.062	27
290.442-444	315	321.510	239	350.515	207	380.326-328	195	421.480	44	460.116	169	470.065	28
290.450	331			350.560-571	211	380.331	194	421.500	258	460.117	127	470.090	26
290.470-475	328	330.869	240	350.674	212	380.332	193			460.133	165	470.091	25
290.480	325	330.870	236	350.940	216	380.337-339	197	430.000-001	198	460.134	169	470.098	27
290.485-490	328	330.904-910	236	350.997-998	215	380.343	170	430.010	305	460.135-136	115, 160	470.101-102	26
290.546	320	330.923-924	301, 239	350.998	73	380.350	338	430.020-025	198	460.136	75	470.104	30
290.550	325	330.981	242			380.999	75	430.055-058	205	460.0139/1	9	470.115	28, 154
290.562-563	326	330.982-983	52	351.084-092	216			430.057-058	159	460.199	116	470.162-191	28
290.620-625	315			351.175	96, 211	381.021-023	196	430.076-078	207	460.222-226	158	470.192	27
290.643	318	331.629-638	141	351.181-182	214	381.074-083	195	430.085	206	460.303-306	160	470.222-228	21
290.651	320	331.814	241	351.260	205	381.102-103	194	430.170	39	460.316-322	159	470.263	154
290.652	324	331.860-909	240	351.271-272	207	381.174-205	195	430.500	124, 304	460.329	156	470.298-302	32
290.654-664	317	331.922	239	351.322-325	203	381.325	266	430.542	148	460.339	162	470.310-311	95
290.705	316	331.958-984	241	351.500-510	216	381.330	193	430.696-730	304	460.347	159, 210	470.334-341	35
290.714-719	319	331.979	242	351.0525-0526	216	381.0911-0913	197	430.800	260	460.349	162	470.370	34
290.724	325			351.551	216	381.01287	194			460.363	163	470.372	20, 35
290.731-764	327	340.000	150	351.555	229	381.01363-01365	195	431.034-054	206	460.365	98	470.375	35
290.799	320	340.005	149	351.558-562	211			431.060	210	460.370-375	161	470.461-473	33
290.800-802	317	340.015	150	351.568	212	390.105	247	431.070-071	206	460.402-410	155	470.497	32
290.804	320	340.224	149	351.0705	202	390.256-259	292	431.080	207	460.404-406	75	470.500-501	21, 34
290.870.2-14	326	340.228-231	151	351.0895	204			431.120-168	148	460.412	305	470.506-512	33
290.880-885	317	340.232	153			391.104-254	247	431.128	47	460.430-431	159	470.513-514	32
290.901	330	340.233-240	151	360.051	179	391.0626	247	431.400-462	303	460.454-456	192	470.516	28
290.905-919	315	340.323-328	152	360.055	191			431.501-562	304	460.462	166	470.518	34
290.999F	330	340.334	150	360.110	128	420.000	261	431.0609	304	460.464	167	470.519	93
290.1000-1002	327	340.345	67	360.120	131	420.001-003	259	431.638-648	303	460.465	159	470.520-522	32
290.75401-75402	327	340.346	68	360.212	305	420.004	257	431.700	304	460.521	161	470.523	95
		340.347	149	360.885	179	420.005	258	431.01303-1317	303	460.522	163	470.910	127
291.009-337	331	340.380-390	154			420.006	259			460.523	168	470.997-999	30
291.011	37	340.392-394	152	361.259-343	129	420.007	258	450.105	285	460.571	169		
291.560-561	326	340.395-398	154	361.800	128	420.008	259	450.110-125	286	460.573	166	471.026-027	35
291.568-569	328	340.399	153	361.880-884	132	420.009	261	450.127-128	283	460.577	164	471.031-053	27
291.570	321	340.401	67	361.01556	130	420.0100-0101	259	450.300	283	460.578	116, 167	471.087	25
291.580	315	340.611	152			420.101	253	450.320	288	460.580	168	471.100	28
291.608	316	340.909-930	213	370.000	305	420.103	254	450.380-388	285	460.585-586	169	471.0106-0138	30
291.650	324			370.184-200	244	420.104	73	450.389-409	286	460.589	168	471.190	25
291.662	321	341.290	152	370.529	243	420.104-106	259	450.505-636	285	460.600	165	471.200-205	29
291.665-667	318	341.300	150	370.530-533	245	420.105-112	260	450.638	287	460.620-622	209	471.0217	154
291.684	321	341.360-361	154	370.534	75	420.114	258	450.644-645	285	460.662	117	471.224-239	29
291.695	324	341.367	150	370.534-704	243	420.115-116	256	450.648-692	286	460.803	164	471.0231-0237	30
291.712	325	341.370-377	154	370.820	242	420.118-119	257			460.805	84, 160	471.256-279	29
291.770-774	327	341.247029	154	370.870	305	420.125-126	256	451.0130-0135	287	460.806-810	156	471.258-259	148
291.875	330			370.880-890	246	420.130-132	255	451.136	283	460.815	157	471.312-313	34
291.900	329	350.000	214			420.173	253	451.202-226	288	460.816	75, 117, 160	471.320-433	33
291.905	328	350.081-087	216	371.110-178	244	420.0206-0209	258	451.0230-0233	287	460.818-823	156	471.457	34
291.910-915	322	350.088	206	371.0181-0183	243	420.0211	257	451.306-315	283	460.826-828	166	471.464-496	33
291.916	324	350.090	205	371.212-246	245	420.0215	258	451.405	286	460.829	167	471.502-503	34
291.917	322	350.103	215	371.0362	246	420.250-258	253	451.592-604	287	460.997-999	117	471.510-525	35
291.71010-71011	325	350.105	211, 304	371.0365-0412	244	420.0300	260	451.640-643	285	460.999	75	471.526-529	333
		350.123	215	371.550-646	243	420.305-311	96	451.690	197			471.769	30
301.107-211	236	350.124-128	213	371.710	245	420.350/1.00	253	451.690-696	287	461.001	113	471.780-788	31
301.450-529	237	350.156-157	214	371.760-769	127	420.360-362	257	451.712	283	461.039A	102, 161	471.0806-0807	154
301.582-624	238	350.159	74, 75, 212	371.781-837	242	420.364	258	451.800-884	289	461.058	157	471.850-900	127
		350.170	216	371.850-877	128	420.365	257			461.0059	165	471.03101	27

NUMERICAL INDEX

471.4000-4130	332	521.101-200	247	541.423	282	570.854-860	181	590.015	110	590.311-317	112	590.708	225
471.78002-78801	31	521.461-476	178	541.440-444	280	570.921	9	590.017	73, 116	590.319	114	590.709	71
471.80114	30	521.482-558	177	541.448-449	279	570.921-922	190	590.018	78	590.320	186	590.710	99
		521.571-573	176	541.460-462	280	570.922-924	9	590.019	79	590.320-322	103	590.711	64
480.002-005	208	521.0720-0725	176	541.468-469	279	570.961-962	184	590.020	89	590.341	101	590.712	97
480.050	202	521.0730-0736	177	541.470	282	570.976-978	185	590.021	83, 88	590.342-343	104	590.714	99
480.100	208	521.749	178	541.472-473	280	570.980	99, 186	590.022	84, 89	590.364	110	590.720	97
480.110	250	521.0762	177	541.501-522	282	570.990-991	190	590.028	109	590.400	104	590.725	85
480.120-123	208	521.850-888	178	541.722-756	278			590.029	116	590.403-404	90	590.730	225
480.180-181	201	521.950-962	133	541.774	273	571.060-080	298	590.030	91	590.406	83	590.745	227
480.230	189, 274	521.74901-74904	178	541.800-811	278	571.162-167	181	590.031-032	109	590.407	86	590.750-752	226
480.232	188			541.0960-0961	273	571.208	183	590.035	106	590.408-409	76	590.774	78
480.300	203	530.000	169			571.244	180	590.037	89	590.410-412	77	590.775	84
480.317-352	202	530.001	193	550.000	69	571.249-255	183	590.038-039	111	590.420	78	590.782-784	101
480.360	203	530.011	126	550.003-025	71	571.256	180	590.043	247	590.425-426	84	590.785-791	226
480.405	274, 192	530.020	168	550.100-101	69	571.259-296	182	590.045-046	78	590.475	79	590.0791/1	80
480.700	277	530.140-142	210	550.102	65	571.309-312	180	590.047	74, 79	590.485-486	109	590.794	86
		530.144-185	209	550.103	63	571.0350-0450	188	590.049	86	590.500	88	590.795	74, 85
481.105-130	208	530.195	143	550.104-107	69	571.489-490	182	590.055	80	590.501-506	82	590.796	85
481.192-228	201	530.200	171	550.108	63	571.512-515	180	590.056	78	590.507-519	88	590.797	226
481.0610-0611	201	530.206	191, 321	550.110-111	71	571.516-520	183	590.058	93	590.521-532	87	590.798-799	86
481.0700	208	530.300-302	193	550.112	64	571.522-523	182	590.060	69	590.534-538	88	590.800	105
		530.400	209	550.251-323	132	571.524-570	181	590.064	112	590.540-543	87	590.801	26
490.001-438	249	530.801-820	171	550.451	71	571.590-595	188	590.068-071	109	590.545	115	590.802	85, 89
490.799	248	530.3005	193	550.555-556	70	571.591	190	590.080	83	590.546-548	88	590.804	87
				550.5555-TC	70	571.601-604	188	590.081-083	111	590.549	84	590.805	89
						571.605-622	187	590.084	115	590.550-554	364	590.806	80
491.100-320	249	531.013-112	126	551.200	132	571.700-713	189	590.085	111	590.555	86	590.807	79
491.320	302	531.120-132	147	551.750	210	571.0715AP	180	590.086	91	590.555TK	70	590.808-811	88
491.475-477	249	531.150	209	551.02401	132	571.716-721	189	590.087	92	590.570	82	590.814-817	105
491.700-891	248	531.161-183	126			571.730	186	590.089	73, 91	590.580	110	590.818	74, 77
		531.201-205	171			571.750-774	189	590.090-092	74, 80	590.588	66	590.819	105
500.205-956	367	531.0210	126	560.305	124	571.777	9, 190	590.093	103	590.592	111	590.820	98
		531.620-836	171	560.710-711	224	571.821	190	590.095	77	590.600	90	590.821-823	105
501.251	219	531.0660	147	560.738	225	571.850-866	181	590.099	80	590.602	94	590.824-827	88
501.265	218	531.0917	171	560.799-806	224	571.936	188	590.101	102	590.608	227	590.832, 832B	76
		531.01400	169	560.807-817	222	571.958	74, 185	590.102	94	590.610	73	590.833-841	97
				560.818	230	571.975	187	590.104-105	85, 87	590.613	92	590.843-844	66
510.004-007	219	532 - 552	429	560.820-827	222	571.01102-01202	183	590.114-119	111	590.614-621	89	590.850	78
510.015	220			560.829	223	571.01107	180	590.117	107	590.629	101	590.851-853	91
510.092	231	540.001-006	275, 279	560.830	224	571.01130-01136	182	590.118	75	590.630-633	111	590.854	65
510.095	229	540.060-061	276	560.900	278	571.01139	181	590.121	110	590.635	112	590.855	97
510.096-099	231	540.080-085	192	560.901	282	571.01206	183	590.122	89	590.636	83	590.857	65
510.109	218	540.093	262			571.01207	180	590.123	101	590.637	115	590.859	66
510.117-118	217	540.095	192	561.705-707	224	571.01244	182	590.125-142	91	590.639	98	590.864	98
510.150	220	540.128-132	277	561.737	225	571.01250	186	590.151-157	89	590.641-644	97	590.869	227
510.210	218	540.131-132	302	561.748	224	571.01400-01401	9	590.158-159	85	590.648	79	590.871	79, 102
510.670	220	540.135	262	561.762-792	221			590.160-162	89	590.649	77	590.872	85, 87
		540.201	277			580.001	251	590.180-193	110	590.650	82	590.873	63
511.093	218	540.203-233	276	570.000-003	229	580.002	250	590.195	77	590.650-651	88	590.874	13
511.098	231	540.299	284	570.005-009	187	580.003	153	590.201	73, 92, 251	590.651-0655	82	590.875-877	105
511.0560-0565	231	540.300-416	280	570.052	298	580.008	153, 250	590.202	81	590.660	93	590.879	63
511.0906	218	540.452	278	570.058	304	580.009	146, 153	590.230	110	590.661	83	590.881	64
		540.506	284	570.200-237	183	580.100	118	590.240-241	90	590.662	88	590.883	77
520.001-004	176	540.600	282	570.276	182	580.135	251	590.244	91	590.663	112	590.884	81
520.005	175	540.663	279	570.280	184	580.235-300	118	590.245-246	99	590.664-665	93	590.885-886	76
520.006	179	540.701-703	281	570.299	189, 274	580.300	73	590.250	83	590.666	83	590.887	92
520.008	174	540.771-776	273	570.300-304	184			590.255-258	78	590.667	94	590.888	84
520.009	179	540.829-836	281	570.0398	189, 274	581.101-141	251	590.261-265	76	590.671-672	113	590.890	262
520.015	172	540.901	282	570.435-556	181	581.200-205	118	590.276	336	590.673	111	590.891	226
520.189	74	540.930	273	570.557	180	581.215	119	590.281	90	590.674-678	114	590.895	104
520.286	174	540.935	280	570.596-599	185	581.221-232	118	590.283	78	590.675	75	590.896	81
520.299-410	176	540.940-950	281	570.617	187	581.240	119	590.285	113	590.679	110	590.897	63
520.480	177	540.955	273	570.634-637	191	581.250	118	590.286	91	590.680-683	336	590.899	63
520.500	74, 75, 172	540.990-999	275	570.638	191	581.0519-0528	251	590.287	90	590.681	92	590.907	178
520.516	178			570.638-640	229			590.292	108, 212	590.682	90	590.920	96
520.525	175	541.050	273	570.650	185	590.000	84	590.293	73, 95	590.684	109	590.925	76
520.541	172	541.090	192	570.752-753	189	590.001	114	590.300	110	590.686-691	114	590.938	96
520.542-544	175	541.116-172	277	570.759-761	190	590.002	116	590.301	99	590.692-693	109	590.944	117
520.576	174	541.252	282	570.759-762	274	590.003	76	590.302-304	109	590.697	114	590.947	109
520.600	215	541.0340-0341	280	570.762	190	590.004-011	116	590.305	67	590.698	100	590.948	80
520.605-766	172	541.402-410	282	570.800-807	184	590.012	74, 75, 109	590.309	97	590.704	228	590.949	13
520.953	133	541.415	280	570.830	180	590.013	116	590.310	73, 100	590.707	230	590.953	92
520.963	179												

590.954	79	610.203	63	640.400	83	640.7820	93	680.050	433	900.015	418	900.862	413
590.955	63	610.220-242	344	640.0614	106	640.7825	186	680.051-052	428, 379	900.016	419	900.872	408
590.956	79	610.309-313	357	640.701-710	19	640.7871	173	680.058-064	368	900.017	420	900.881	390
590.960-961	82	610.315-328	362	640.715	340	640.7916	60	680.060	427	900.018	421	900.882	405
590.965	365	610.330	229	640.1199	48	640.7922	107	680.065-070	429	900.019	420	900.915	388
590.967	77	610.331-339	362	640.1282.D	42	640.7971	95	680.071-075	432	900.023	418	900.925	387
590.971	365	610.475-476	352	640.1300.6	60	640.7982.60-85	340	680.076	428	900.024	421		
590.973-974	86	610.501	360	640.1438.C3	245	640.7990	107	680.077-078	427	900.025	108, 415	901.023	414
590.985	14	610.502-518	358	640.1842	119	640.8745	116	680.080	426	900.026	399	901.025	383
590.988-989	96	610.530-559	358, 359	640.1884	104	640.8899	173	680.082-084	427	900.027	420	901.026	390
590.990-992	114	610.560-564	340	640.1897	102	640.30018	97	680.087	428	900.028-029	419	901.027-028	383
590.996	81	610.566-570	352	640.2229	106	640.30021-30026	119	680.090	427	900.030	402	901.030	414
590.997	103	610.574-575	356	640.2461	179	640.30080	174	680.095	379	900.033	420	901.031	383
590.998	81	610.576	360	640.2462	132	640.30081	173	680.448	430	900.034	419	901.035	414
590.1530-3135	105	610.578-582	355	640.2611	316	640.30082.M	105	680.449	432	900.036-038	412	901.036	390
590.05501-05509	80	610.584-585	360	640.2718-2720	252	640.30097.BC	336	680.450	429	900.039	418	901.050-056	414
590.7750	90	610.586	358	640.2729	105	640.30106	92	680.649-655	430	900.040-042	421	901.060	404
590.81101	88	610.587-588	352	640.2835A-F	82	640.30180-A	253	680.656-667	432	900.044	416	901.070	414
		610.591-594	355	640.4040P	90	640.30416	245	680.670-671	430	900.046	405	901.120	387
591.048	86	610.595	358	640.4056	42	640.30432	118			900.047	73	901.609	408
591.050-054	80	610.600-611	349	640.4251	134	640.30460.VI	106	690.004	368	900.049	422		
591.088-278	91	610.666-668	357	640.4722	252	640.30514.60	254			900.052	401	902.000-001	378
591.280	90	610.700	356	640.4734-4735	254	640.30543-30544	98	730.011-012	124	900.055	392	902.540	385
591.284	91	610.720-765	343	640.4743-4744	252	640.30548	104	730.205	123	900.059-065	406		
591.0285	74	610.780-800	361	640.5000	180	640.30610	101	730.302-303	367	900.066	75	903.001	378
591.0300	91	610.810	344	640.5011	94	640.30671.7	100			900.066-067	379	903.090	408
591.0310	107	610.816	361	640.5236	207	640.BERG	306, 70	740.020	124	900.068	392		
591.0345-0346	100	610.1260-9108	345	640.5374	106			740.306-612	123	900.069	379	904.001-003	378
591.0520	96			640.5393-5395	336	641.1967	124	740.990	124	900.072-077	385	904.012-014	393
591.0620	76	611.051-053	344	640.5409	96	641.2321	68			900.080	383	904.401	415
591.0625	79	611.075	345	640.5500	86	641.2533	86	741.214-368	123	900.084	389	904.903	416
591.0637	83	611.080	230	640.5500-4	87	641.2659	124			900.084-086	73		
591.0890	108	611.095-097	345	640.5555	70	641.2729-2795	105	781.123-208	124	900.085-086	387	905.102	408
		611.110-115	341	640.5670	261	641.3007	107			900.087	390	905.130-520	396
601.060-075	342	611.0131-0133	341	640.5733	262	641.3044	173	790.000-001	360	900.088	380	905.610	397
601.700-718	343	611.171	231	640.5860	119	641.4079-4344	100	790.004-005	364	900.090	399		
		611.173-182	344	640.5914.1612	90	641.4733	102			900.090-091	73	906.009	377
610.001	354	611.193-300	339	640.5971.100-180	174	641.4852	104	800.220-222	108	900.091	395	906.011	381
610.003-010	353	611.0585-0625	231	640.6111	109	641.4932	79	800.500	417	900.095	401	906.012	379
610.012	358	611.0760	230	640.6168	48	641.5060	99			900.096	383	906.015	414
610.013	356	611.820-865	343	640.6403	77	641.5896	104	810.000	75	900.096-098	73	906.031	404
610.014	352	611.15101-16001	341	640.6460-6571	185	641.6603-11	182	810.220-221	436	900.098	401	906.037-038	385
610.015-016	355			640.6671	180	641.10008-10085	124	810.224	335	900.099	388	906.039	381
610.017-018	354	620.000	310	640.6723.240LP	48	641.30013-30020	98	810.227	74	900.100	73, 418	906.054	380
610.020-022	356	620.020-030	306	640.6744	114	641.30180	253	810.245	67	900.101-110	306	906.092-093	411
610.023-025	358	620.080-081	340	640.6751	180	641.30209	101			900.120-127	424	906.612	397
610.026-028	356	620.170-171	308	640.6759.2	336	641.30433	102	811.701	417	900.128	389	906.613	399
610.029-037	359	620.204-205	309	640.6767	109	641.30543-30544	134			900.129	383	906.669	412
610.038-045	354	620.476-502	307	640.6769	92	641.30637-30669	100	820.001-025	344	900.130-131	424	906.748	397
610.048	359	620.507	306	640.6817	72			820.200-212	366	900.133	73, 407		
610.049	354	620.837-839	309	640.6819	113	650.001	108	820.507-509	262	900.134-135	420	909.003-010	394
610.054-059	353			640.6821	103			820.512	256	900.136-137	407	909.068	403
610.060-065	354	621.224-225	307	640.6878-6879	261	670.000-009	346	820.513-514	255	900.139	408	909.201-252	392
610.061	360	621.405-411	309	640.6899	173	670.100	351	820.603	366	900.140	388	909.260	417
610.066	366	621.412-417	310	640.6918-6919	103	670.200-208	350	820.604	368	900.144	73, 75, 387		
610.087	355	621.443A	308	640.6924	179	670.210	351	820.691	366	900.145	390	910.040-042	415
610.089	366	621.447-450	310	640.6935.3	99	670.300-307	348	820.860	228	900.150	388	910.041-042	108
610.092	344	621.451-460	308	640.6987	79	670.400.1-405.3	349	820.5463-5464	382	900.199	413	910.105	410
610.095	355	621.463	310	640.6988	115	670.502-508	351			900.200	73, 388	910.106	412
610.098	345	621.500	309	640.7007	107, 19	670.512-521	364	821.900	417	900.220	387	910.217-219	416
610.099	361	621.01135	339	640.7011	253	670.600	351			900.240	392	910.229-233	392
610.100-107	358	621.01215	308, 285	640.7013.4	252	670.606-706	350			900.280	380	910.619-623	404
610.120-141	340			640.7029	180	670.800-803	347	830.004-005	332	900.299	413		
610.150-151	230	630.011	307	640.7033-7040	20	670.900-902	344	830.007-008	357	900.331-338	395	912.402	415
610.152	359	630.013	310	640.7053N	92					900.400	381		
610.153	356	630.021-033	343	640.7116	52	680.001	430	871.150	417	900.610	411	914.035	404
610.154	359	630.172-185	342	640.7140	186	680.005-006	427			900.624	413		
610.155	354	630.192	310	640.7153	96	680.014-015	426	900.002-003	411	900.628	394	916.002-500	437
610.156	355	630.200-202	343	640.7216	266	680.018	433	900.006	399	900.629	386		
610.160-162	344	630.300-304	340	640.7721	252	680.020-025	427	900.007	395	900.638	384	922.070-100	391
610.165-173	341	630.702-926	342	640.7802-7803	64	680.027	426	900.008	400	900.639	391		
610.190-192	344			640.7808.1-3	338	680.033-035	429	900.009	395	900.851	409	930.057	399
610.200-202	65	640.000	19	640.7812	72	680.040-041	426	900.010	383	900.861	412		
								900.012-014	412				

INDEX - NUMERICAL

932.035-065	384	C63.87800	402
940.008	409	DTJ-41 -3643	434
940.125	409		
940.175	410	F40-0512 -0918	428
		F60-0112	428
956.035-045	393	F66-0106	428
956.055	394	F601-0108 -0118	428
956.065	384	FY90-0116	428
		VFS60-0213	428
959.016	391		
959.025	392	VLS68-0213	428
959.035	391	VMS67-0213	428
		WB-17 -70	431
980.100-124	122	WB-150 -410	433
980.145	380	WB-3640 -3649	433
980.200	121		
980.270-273	381		
980.300	377		
980.310-311	379		
980.320	377		
980.329	381		
980.330-649	377		
980.812-893	121		
980.902-910	120		
980.992	121		
980.1020	122		
980.4494	124		
999.011-012	400		
999.015	402		
999.020	384		
999.027	387		
999.031	388		
999.067	403		
999.073	400		
999.077	416		
999.096-099	389		
999.101	411		
999.112	402		
999.113	404		
999.114	411		
999.120	384		
999.121	405		
999.122-125	406		
999.126	388		
999.128	381		
999.129	402		
999.131-132	381		
999.135	402		
999.143	404		
999.187-189	400		
999.200-203	397		
999.204-215	398		
999.240-242	391		
999.260-280	377, 381		
999.400	415		
999.401	405		
999.500	414		
999.625.07-08	108		
999.628	394		
999.634-635	401		
999.642	413		
999.658	392		
999.659	386		
999.663	401		

INDEX - ALPHABETICAL

A		Blocks	125-126
Abrasive Bands	38, 43	Bobs	54
Abrasive Cones	43	Books	306-310
Abrasive Files	45	Borax Flux	291
Abrasive Papers & Cloths	41	Boric Acid	282
Abrasive Rods	40	Bottles	334, 254-255
Abrasive Rolls	42	Bows, Pocket Watch	368
Abrasives	36-49	Bows & Ribbon	344
Abrasive Sticks	42	Boxes	346-350
Abrasive Wheels	36-48, 49	Boxes, Storage	335-336
Acid Solutions	224	Bracelet Buddy	357
Adhesive Curing	94	Bracelet Sizers	193, 203
Adhesive Removers	266	Bracelet Tools	111-112
Adhesives	95, 263-266	Bristle Disks	38
Adjustment Keys	103	Broaches	134, 98
Air Dusters	262	Brushes	56-62
Alcohol Cups	254	Brushes, Mandrel	57
Alcohol Lamps	272	Brush Wheels	56-59
Aluminum Oxide Wheels	37	Buckles for Watch Straps	379
Analyzers, Watch	63-64	Buckles, Watchstrap	377
Anodes	287	Buff Rake	52
Antiquing Solution	287	Bufs	48, 50-55
Anvils	125	Bur & Blade Lubricant	248
Applicators	259, 263	Burnishers	133
Appraisal Forms	231	Burnishing Compound	30
Aprons	332	Burnout Furnace	290
Assortments, Jewelry		Burs	135-144, 302
	369, 370, 373, 375	Bur Storage	144
Assortments, Watch Parts		Butterfly Clasps, Watch Band	377
	377-384		
Aul Solvent	287		
		C	
B		Calibration Weights	218
Bags, Gift	344	Calipers	104, 214
Bags, Poly Zip	340	Cannon Pinion Tightener	102
Balance Screw Regulator	102	Carrying Cases & Totes	361
Balance Tools	107	Carving Tools	301-302
Barrel Arbor Tools	101	Case Back Labels	343
Baskets	6, 8, 254	Case & Crown Tubes	393-394
Batteries	437	Case Dies	87
Battery Clamps	416	Case Dies, Nylon	89
Battery Cross Reference	438	Case Holder	92
Battery Kits	74-75, 436	Case Knives	77, 78
Battery Order Form	437	Case Opener Dies	84, 88
Battery Parts	416	Case Opener for Rolex	83-85
Battery Testers	68-69	Case Openers	77-80, 102
Bead Board	194-195	Case Opener, Suction	78, 83, 86
Bead Cord	195, 196	Case Pliers	84
Bead Crimps	196	Case Press	81, 84, 85, 86
Beading Block	126	Case Vise	91
Beading Needles	197	Case Wrench	80
Beading Supplies	194-201	Casing Cushions	336
Beading Tools	193	Casting	290-302
Beakers	296, 285	Casting Alloy	281
Beeswax	197, 267	Casting Flasks	297
Benches & Desks	311-312	Casting Metals	303
Bench Knives	247	Casting Supplies	284
Bench Pads	338	Ceramic Polish	32
Bench Pins	250	Ceramic Enameling	289
Bench Stones	44	Chains	374-375
Benchtop Organizers	312	Chains, Pocket Watch	368
Bench Trays	339	Charcoal Blocks	277
Bezel Tools	93	Chargers	67
Blade Lubricant	248	Chronograph Pusher Tool	101

Chucks	29	Diamond Cleaner	22	Flexible Shaft Machines	150-155	Investment	291
Circuit Repair	108	Diamond Graders	228	Flex-Shaft Accessories	152-155	Ionic Cleaners	6
Circuit Testers	66	Diamond Light	228	Flux Brushes	60	Ionic Cleaning Solutions	6
Circular Saws	248	Diamond Papers	230	Flux Solutions	275, 279, 280, 282	J	
Clamps, Watch Case	415	Diamond Supplies	229-231	Fomblin Grease	259	Jeweler's Workshop	2
Clasps, Watch Band	378-380	Diamond Testers	225-228	Friction Jewel Tool	106	Jewelry Cleaner	18
Clean Earth Solutions	288	Dichroscope	230	Fume Extractor	277	Jewelry Cleaners	4-5, 17-20
Cleaners	262	Display Cases	358-360	G		Jewelry Display Pins	340
Cleaning Block	253	Display Domes	367	Gaskets	407-410, 411	Jewelry Findings	371-378, 372-379, 374-381, 376-383
Cleaning Machines	3-14	Display Folders	360	Gaskets, Case Back	407-408	Jewelry Shield	332
Cleaning Solutions	5-6, 15-16, 17-21, 262	Display Hands	357	Gaskets, Crystal	409-410	Jewelry Sizers	193, 203
Cleaning Swabs	107	Displays	352	Gauges	211-216	Jewelry Tools	201-208, 305, 232-240
CleanJet Dust Remover	262	Displays, Gem	229-230	Gem Gauges	213	Jewel Setting Polishers	102
Click Springs	124	Dividers	216	GemOro Cleaning Solutions	17	Jump Rings	369, 376
Clips	404	Draw Traps	21	Gem Testers	225-228, 230	K	
Clock Cleaning Solutions	15	Draw Tools	304	Gift Bags	344	Keys for Clocks & Pocket	
Clock Hands	122	Drill Press	146	Gift Boxes	346-351	Watches	123
Clock Keys	123	Drills	146-148	Gift Boxes, Cardboard	346	Knives	247
Clock Movements	121	Drill Storage	144	Gift Boxes, Crystal Clear	350	L	
Clock Oils	257	Droppers	255	Gift Boxes, Leatherette	347	Lamps	313-314, 323
Clock Parts	124	Dryers	14	Gift Boxes, Novelty	351	Lap Wheel	48
Clock Tools	124	Dust Blowers	262	Gift Boxes, Nylon Flock	348	Lathe Belting	154
Coddington	319	Dust Collectors	25-27	Gift Boxes, Petite Hat	350	Leak Tester	71
Coin Mountings	372-373	Dust Cover	336	Gift Boxes, Velvet	349	Little Torch	268
Collet Tool	107	Dusting Brushes	62	Gift Items	362	Liver of Sulphur	287
Compressed Air Dusters	262	Dust Removers	60, 262	Gift Wrap	345	Lobster Claw Clasps	371
Compressor	71	E		Gloves	24, 298, 333	Loupe Holders	320
Conductive Epoxy	108	Earwire Makers	305	Glue Dissolver	266	Loupes	315-320
Connoisseurs Cleaner	5	ElectroCleaner	286	Glues	264-265	L&R Cleaning Solutions	15, 18
Connoisseurs Jewelry Cleaner	18, 22-23	Electrolyte Solutions	275, 279	Goggles	331	Lubricants	248, 147, 256
Cord	195-196, 379	Electroplating	285-288	Gold Polish	21, 32	Lug Gauge	74
Cotton Filled Boxes	346	Emery Paper & Cloth	41	Gold Testers	221-224	Lugs, Watch Bracelet	385
Crimpers	169	Emery Sticks	42, 45	Graders, Diamond	228	Luminous Paste	96
Crown Pusher Tool	101	Enameling	289	Graver Handles & Holders	128	M	
Crowns	395-400	Engravers	130-131	Gravers	129	Magic Solutions	284
Crown Winders	101	Engraving Supplies	267	Graver Sharpeners	132	Magnetism Tester	68
Crucibles	261, 298, 300	Envelopes, Job & Repair	341	Grease	256	Magnifiers	321-329
Crystal Adhesives	263	Epilames	255	Guard Chains	374	Magnifiers, Headband	325-328
Crystal/Case Press	86	Epoxy	265-266	Gum Arabic	197	Magnifiers, Lighted	322-324
Crystal Cleaning Stick	266	Escapement Files	239	H		Magnifiers, Spectacle	327
Crystal Lifts	94	Escapement Tester	106	Hair Spring Cleaner	256	Magnifying Tools	191
Crystals, Watch	418-423, 418-425	Eyeloupes	315-320	Hammers	243-246	Mainspring Tools	102, 105
Cubic Zirconia	228	F		Handles & Punches	127	Mallets	243
Cups	231, 254	Face Shields	331	Hands, Clock	122	Mandrels	39, 47, 148
Curing Lamp	94	Felt Bobs	54	Hands, Watch	412-414	Mandrels, Jewelry	205-206
Currency Tester	228	File Cleaners	242	Hands, Watch - Dauphine & Stick	412	Marking Materials	267
Cut-Off Wheels	46	File Handles	242	Hands, Watch - Luminous	413	Masking Pen	288
Cutters	156, 166	Files	232-240	Hand Tools	100	Mats & Pads	338
Cutters, Jewelers'	164	Files, Diamond	241	Heat Shields	279	Measurements Charts	439
Cutters, Parallel Action	167	Files, Escapement	239	Hemostats	192	Medical Alert Jewelry	434-435
Cutting Broaches	134	Files, Needle	236-238, 240	Hoke-Jewel Torches	270	Melting Dishes	298-300
Cuttlefish Bone	299	Files, Pillar	234	Holder, Diamond & Gem	229	Metals	303
D		Files, Precision	45	Holders	250-251, 277, 192, 271	Micrometers	213
Dapping Block	126	Files, Valtitan	236	Hoses	270	Microscopes	328-330
Degreaser	262	Files, Wax	301, 239	Hot Plate	283, 69	Milgrain	126
Degreasers	256	Filters	25, 26, 28	I		Mirrors	357
Demagnetizers	64-66	Findings	369, 371-378, 372-379, 374-381, 376-383	Incabloc Tools	103	Mixing Bowls	299
Dial Dots & Strips	108, 415	Finger Protection	332-333	Inch to Millimeter Conversion	410, 413	Moissanite Testers	225, 225-228
Dial Enamel	96	Firesscoff	278				
Dial Feet	415	Fix-O-Drop	255				
Diamond Cement	267	Flake Shellac	96				

INDEX - ALPHABETICAL

Mold Frames	292	Polishing Cloths	21, 23–24	Screwdriver Sharpeners	179	Testers, Diamond & Gem	225–228
Molding	292–295	Polishing Compounds	32, 35	Screwdrivers, Horotec	175	Testers, Gold	221–224
Molding Rubber	293	Polishing Supplies	20, 21	Screw Remover	261, 101	Testers, Watch	63–64
Money Marker	228	Polyimide Tape	19	Screws, Self-Tapping	417	Testing Solutions	224
Movement Gauge	108	Printers	65, 63, 64	Screws, Watch Repair	391–392	Thermometer	287
Movement Holders	90–91	Prong Lifters	209	Scribers	133	Threadlockers	261
Movement Rests	336	Protective Film	340	Sealants	260, 266	Tiaras	363
Movements, Clock	121–123	Pumice Wheels	37	Sealing Wax	267	Timegrapher	66
Movement Spacers	108, 415	Punches	127	Separating Discs	46	Tissue	344
		Pushers	404	Setting Supplies	267	Titanium Polish	32
N				Sharpening Stones	44	Tivaclean	286
Neck Chains	374–375	Q		Shears	171	Tongs	298
Necklace Sizers	193	Quartz Cleaner	262	Shellac	267	Tool Kits	72
O		Quartz Repair	108	Shock-Absorber Tools	104	Tool Sharpeners	45
Oil Cups & Stands	253–254	Quartz Testers	66	Shock Springs	415	Tool Storage	170, 144
Oilers	252–253	R		Showcase Displays	352	Torches	268–272
Oils & Lubricants	253–256	Record Book	339	Silicone Polishers	36	Torch Lighters	271
Oilstones	44	Refractive Index Liquid	230	Silicone Wheels	36	Trays, Storage	335–336, 339, 361
Optical Parts	417	Regulators	269	Silver Polish	18–22, 34	Trays, Storage & Display	359
Organizers	312	Repair Tags	339	Simichrome Polish	34	Tripods	261, 274
Oscillating Weight Tool	103	Respirators	332	Skin Protection	333	Tripoli	33
P		Retaining Compounds	261	Slurry Strips	41	Tumblers	30–31
Packaging	344–350	Rhodium	286	Sodium Bisulfate	286	Tumbling Media & Shot	30
Pallet Fork Holder	102	Rhodium Solution	287	Solder	278, 281	Tweezers	180–192
Parcel Boxes	230	Ribbon & Bows	344	Soldering	268–272	Tweezers, Bergeon	180
Parts Trays, Storage	334–336	Ring Bender	202	Soldering Blocks	276	Tweezers, Boley	181
Pearl Tools	147	Ring Bezel Tools	210	Soldering Irons	275, 272	Tweezers, Diamond	187
Peg Clamp	128	Ring Clamps	208	Soldering Protection	279	Tweezers, Dumont	182, 183, 184, 187
Pendulums	121–122	Ring Cutters	201	Soldering Solutions	284	Tweezers, Head & Shank	274
Pickling	283, 284	Ring Gauges	203	Solutions	261	Tweezers, Locking	189
Pick-Up Tools	191	Ring Guards	199–200	Solvents	261	Tweezers, Plastic	185
Pike Oil	44	Ring Holders	250, 274	Spectacle Loupes	319	Tweezers, Ring	189
Pin Pushers	110–111	Ring Mandrels	207	Spindles	29	Tweezers, Serrated Tips	188
Pins, Case Hinge	415	Ring Polishers	39	Split Ring Tools	168, 188	Tweezers, Soldering	189, 190, 274
Pins, Watch Bracelet	383–384	Ring Sizers	204–208, 302	Spring Bars	387–389	Tweezers, Steaming	9, 190
Pin Vises	119–120	Ring Stands	277	Spring Bar Tools	110–111	Tweezers, VOH	184
PlastiClean	262	Ring Stretcher	202	Spring Rings	369, 370	Tweezers, Watch Hand	99
Plating	285–288	Riveters	245–246	Springs, Watch Bracelet	382	Tweezers, Watchmakers'	180–186
Plating Guide	308	Rodico Dry Cleaners	20	Sprue Bases	297		
Plating Solutions	286–288	Rolex Repair Tools	105	Stamping Tools	132		
Platinum Polish	32	Roller Remover	104	Steam Cleaner Additive	10		
Pliers	155–170	Rolling Mill	305	Steam Cleaning	7, 10–12		
Pliers, Beading	168–170	Rouge	33	Stems	405–406		
Pliers, Box Joint	164	Rubber Abrasives	39–40	Stem Shortening Tool	103		
Pliers, Economy	155	Rulers	216	Stirring Rods	298		
Pliers, Jewelry Repair	159–160	Rust Remover	261, 256	Stone Setting Pliers	165		
Pliers, Lindstrom	158	S		Stone Setting Tools	209, 210		
Pliers, Parallel Action	167	Safety Equipment	331–333	Storage Cabinet	335		
Pliers, Stone Setting	165	Safety Glasses	37, 331	Storage & Organization	312, 334–336, 341, 230		
Plier Stands	170	Sanding Discs	47	Strap Keepers, Watch Band	379		
Pliers, Watch Repair	160	Saw Blades	249, 302	Super Glue	264		
Pliers, Wubbers	162	Saw Frames	248	Suspension Springs	124		
Pocket Watch Bows	368	Scales	217–220	Swabs	19		
Pocket Watch Keys	123	Scissors	171	T			
Pocket Watch Parts & Accessories	368	Scoops & Shovels	231	Tags	342–343		
Poising Tool	101	Scrapers	247	Tape	19		
Polishers	26–28, 30–31, 39	Scratch Brushes	62	Tape Dispenser	19		
Polishing	21, 32	Screwdrivers	173–176	Taps & Dies	124		
Polishing Blocks	20, 41	Screwdrivers, Bergeon	173–174	Tap to MM Conversion Chart			
Polishing/Buffering Kit	35	Screwdrivers, Economy	172, 176		406		
Polishing Buffs	48	Screwdrivers, Grobet	177	Tarnish Removers	17–18		
				T-Bars, Watch Bracelet	385		
						U	
						Ultrasonic Cleaners	3–7
						Ultrasonic Accessories	8–9
						Ultrasonic Solutions	15–16, 17–18
						Ultrasonic Watch Cleaners	13–14
						UV Adhesives	263
						UV Lamps	94
						V	
						Vacuum Cleaning	26
						Vacuum Pen	60
						Vinyl Wrap	340
						Vises	250–251
						Visors	325–328
						W	
						Watch Analyzers	63–64
						Watch Band Parts	386

Cas-KerCo. Fax Order

FOR THE FASTEST, MOST ACCURATE SERVICE

FAX 1-800-487-5848
or 513-674-0600

Please use BLACK INK for best fax quality.

SHIPPING INSTRUCTIONS

- BEST WAY 1ST CLASS MAIL UPS GROUND
 2-DAY NEXT DAY NEXT DAY-AM

For Next Day: Fax Mon-Thur before 3PM your local time, Fri before 3PM Eastern.

DATE
ACCT. NO.
ACCT. NAME
CONTACT
FAX NO.
CUSTOMER P.O. NO.
CASKER ORDER NO.

LINE	QUANTITY	PART NUMBER/DESCRIPTION	JOB
1			
2			
3			
4			
5			
6			
7			
8			
9			
10			
11			
12			
13			
14			
15			
16			
17			
18			
19			
20			

CAS-KER CO. PO BOX 31167 CINCINNATI OH 45231-0167 PHONE 1-800-487-0408 FAX 1-800-487-5848
 CASKER.COM • EMAIL casker@casker.com • BUSINESS HOURS 8:30AM-5PM EST • 24/7 FAX AND VOICE MAIL

Specialty Catalogs & Price Lists available on request.

Cas-Ker Co.



Cas-Ker Update newsletter #900.107
24 pages of the latest and best!

Battery Price List
Popular Energizer watch batteries and kits.

Packaging #900.106.30
Boxes, bags, gift wrap, displays.

Watch Straps & Bands #900.106.20
Leather, Metal, Sport, and Medical Alert.
WBHQ Straps & Bands Catalog also available.

Jewelry Findings #900.106
Clasps, chains, settings, solder.

Watch Parts Assortments #900.109
Spring bars, stems, crowns, gaskets.

Bulk Watch Parts #900.109.958
Hands, crowns, staffs, screws, jewels.

Pocket Watch Parts #900.109.959
Balance staffs, jewels, screws, dials.

Mainsprings #900.105.10
Elgin, Hamilton, Illinois, Waltham.

Generic Rolex Parts #900.105
Crystals, gaskets, mainsprings, stems.

Mineral Glass Crystals #900.104
Cas-Ker brans MG, sapphire, G-S, BB.

Clock Movements #900.108
Quartz, pendulum, chime, mechanical.

Watch Movements #900.110
ETA, Ronda, Hattori, Miyota, Seiko.



MY CAS-KER
ACCOUNT NUMBER

TOOLS + SUPPLIES FOR JEWELERS AND WATCHMAKERS
2550 CIVIC CENTER DRIVE
CINCINNATI, OH 45231
CASKER@CASKER.COM

Cas-KerCo.

CALL **1-800-487-0408**

FAX **1-800-487-5848**

CASKER.COM

